

APPENDIX A

OWI Storm Data

JRUN001 Data

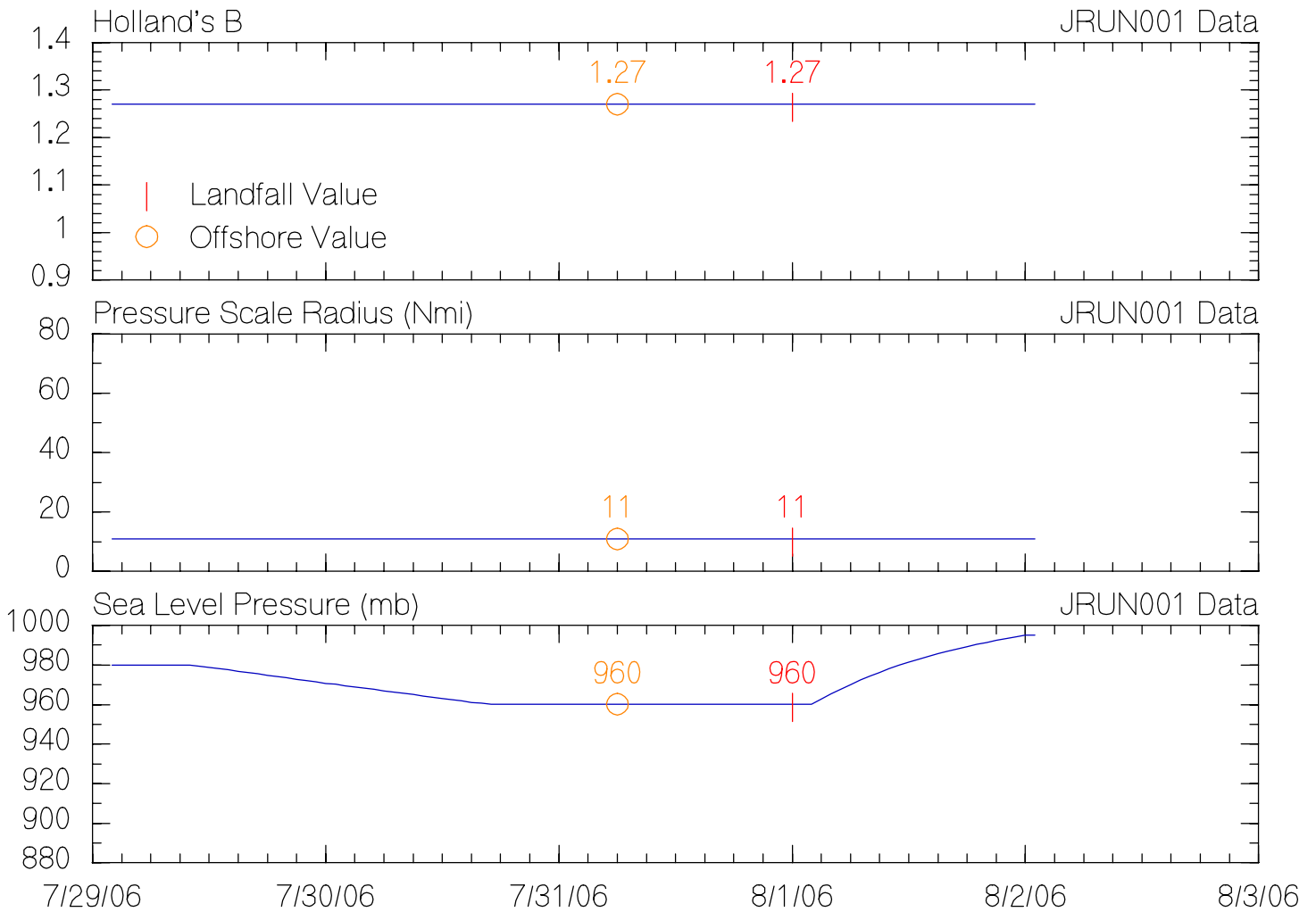
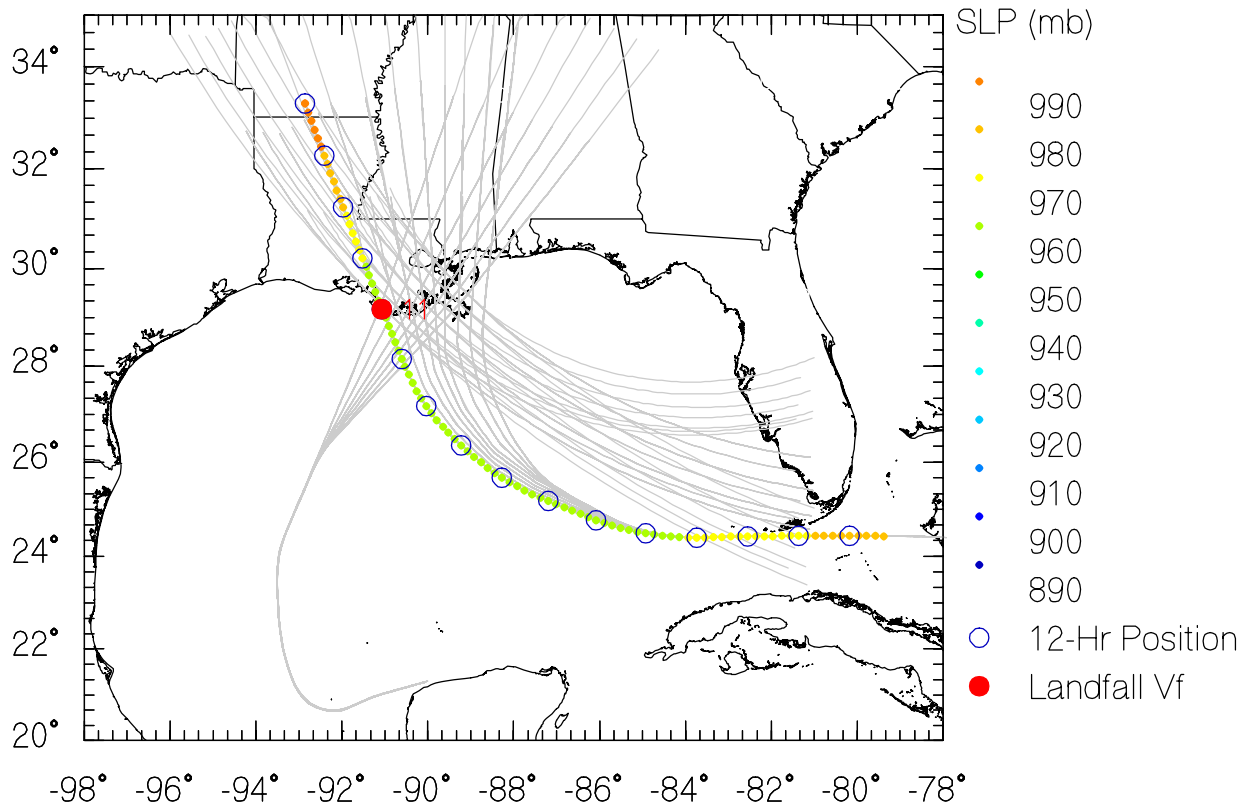

JRUN002 Data

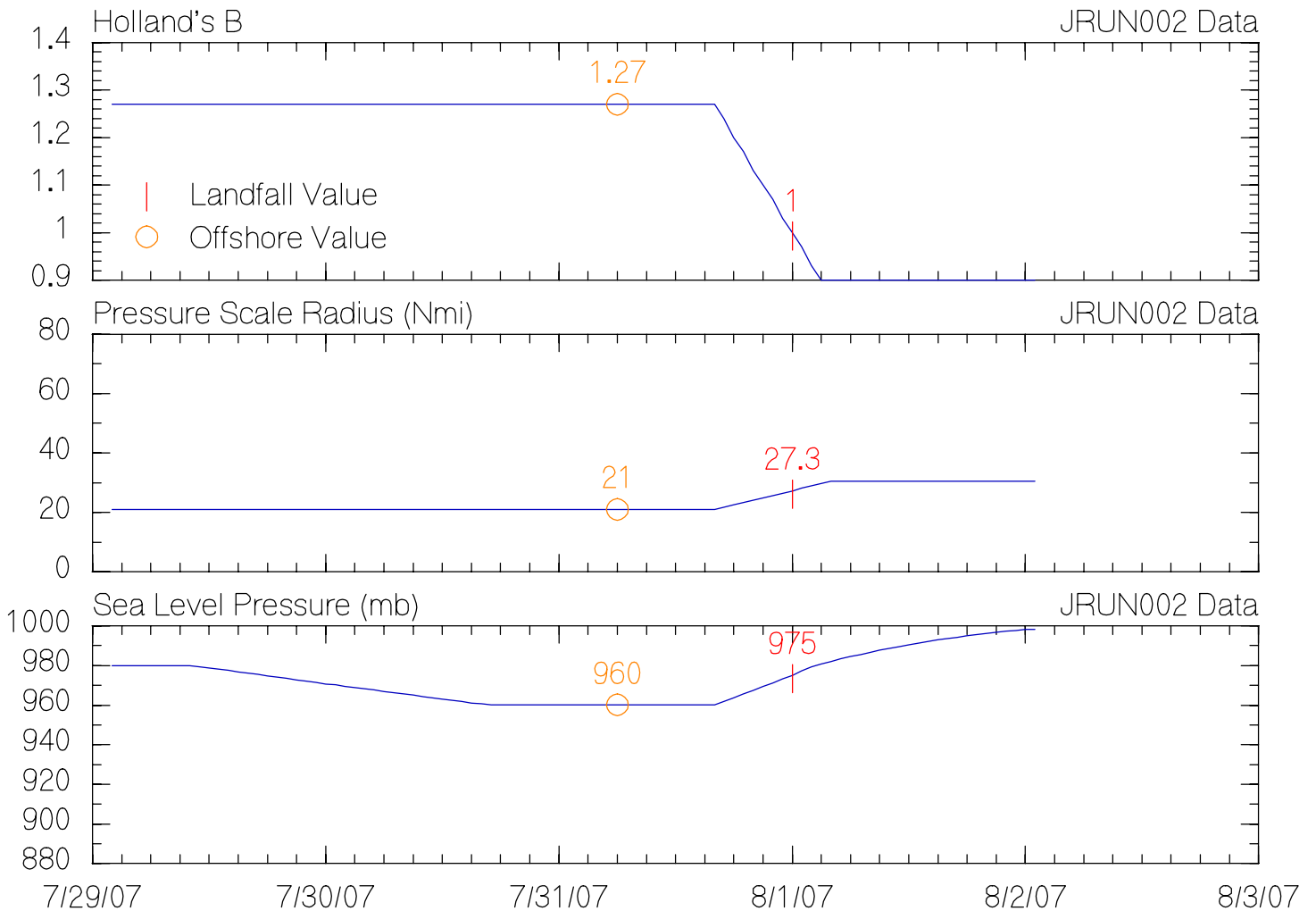
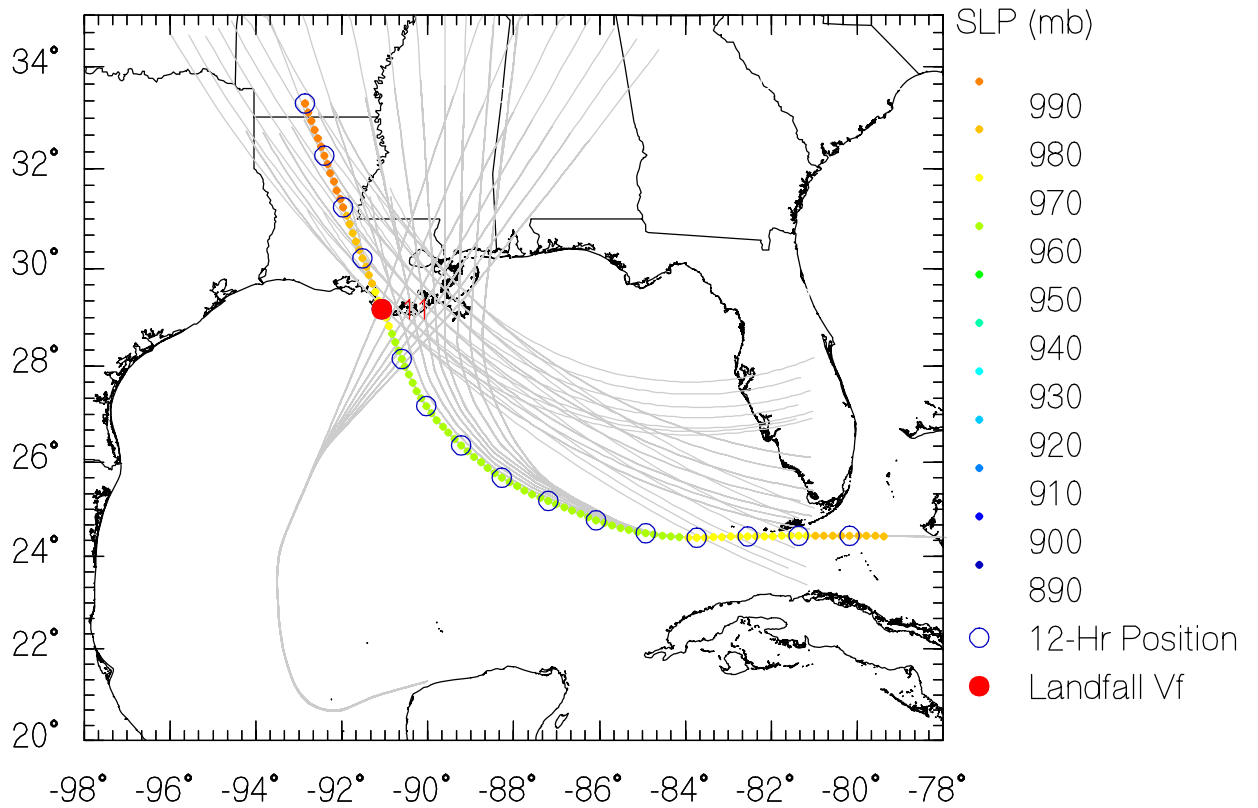

JRUN003 Data

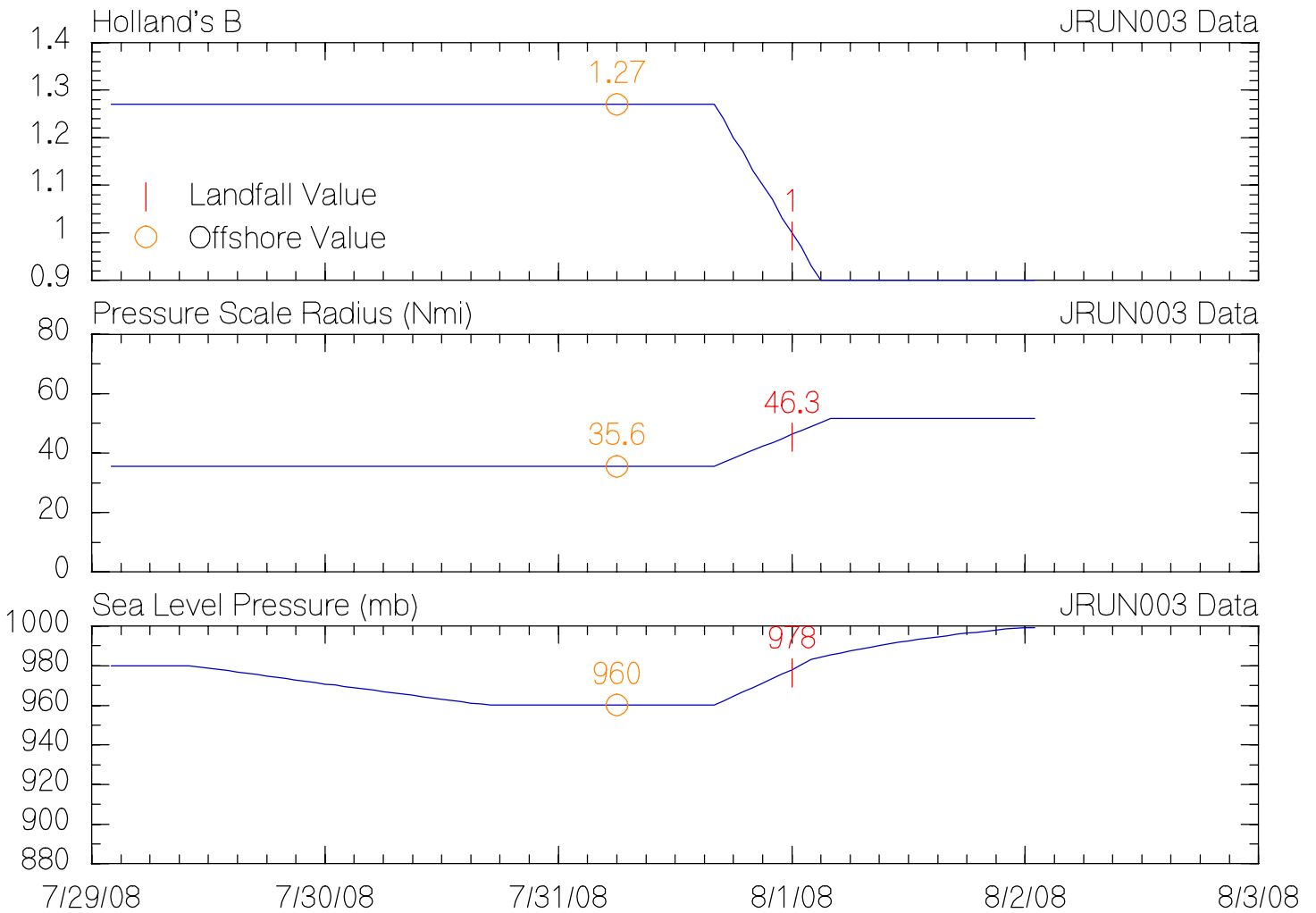
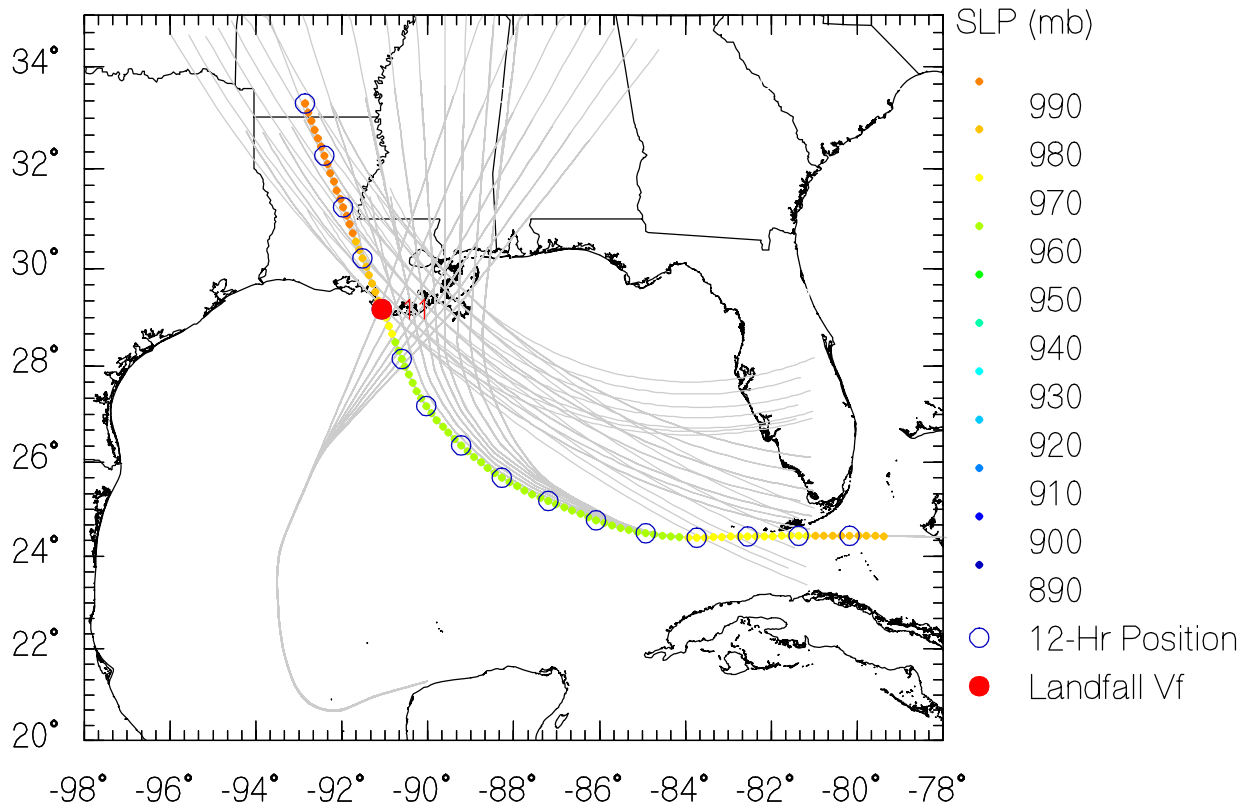

JRUN004 Data

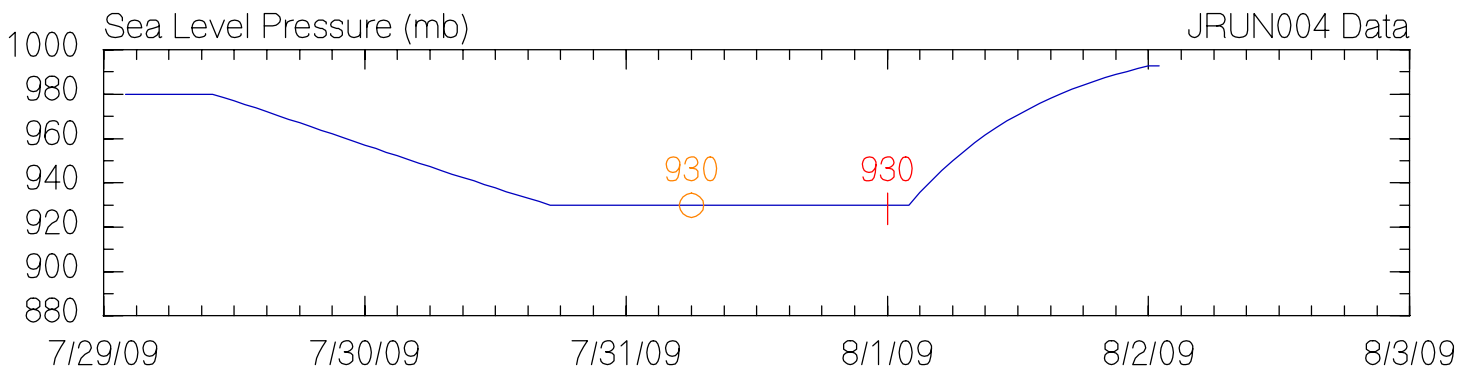
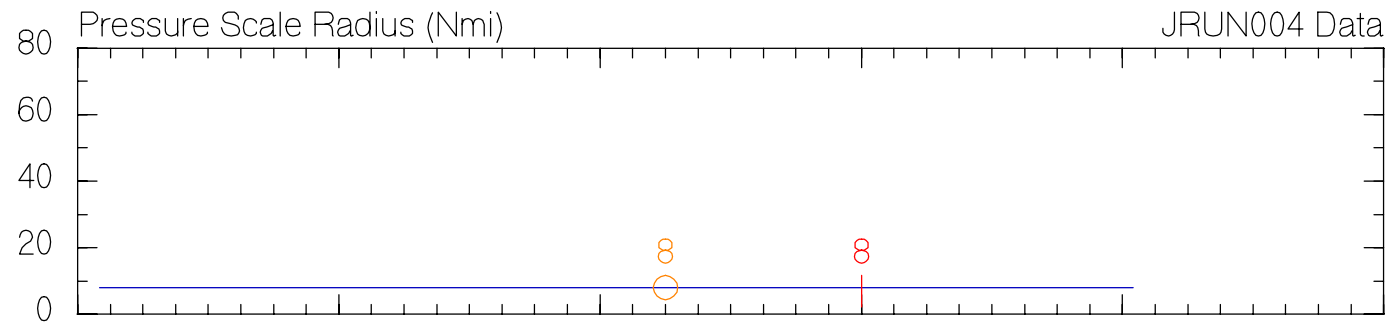
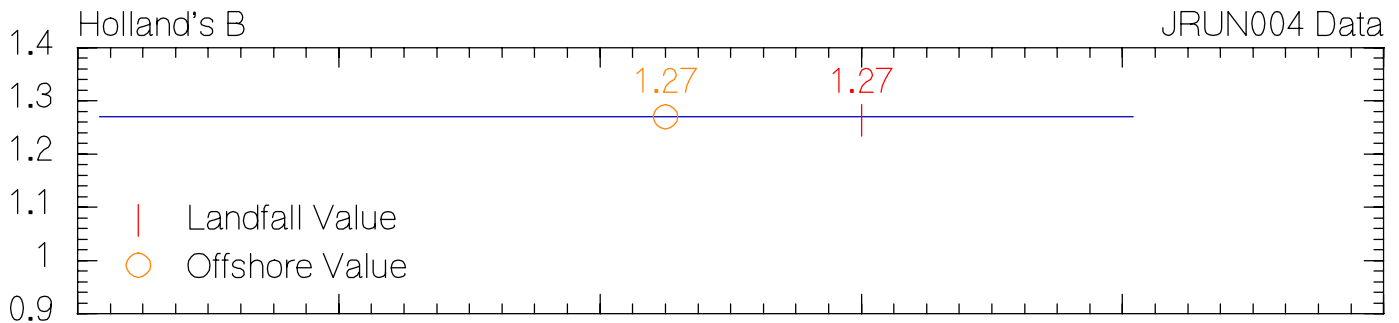
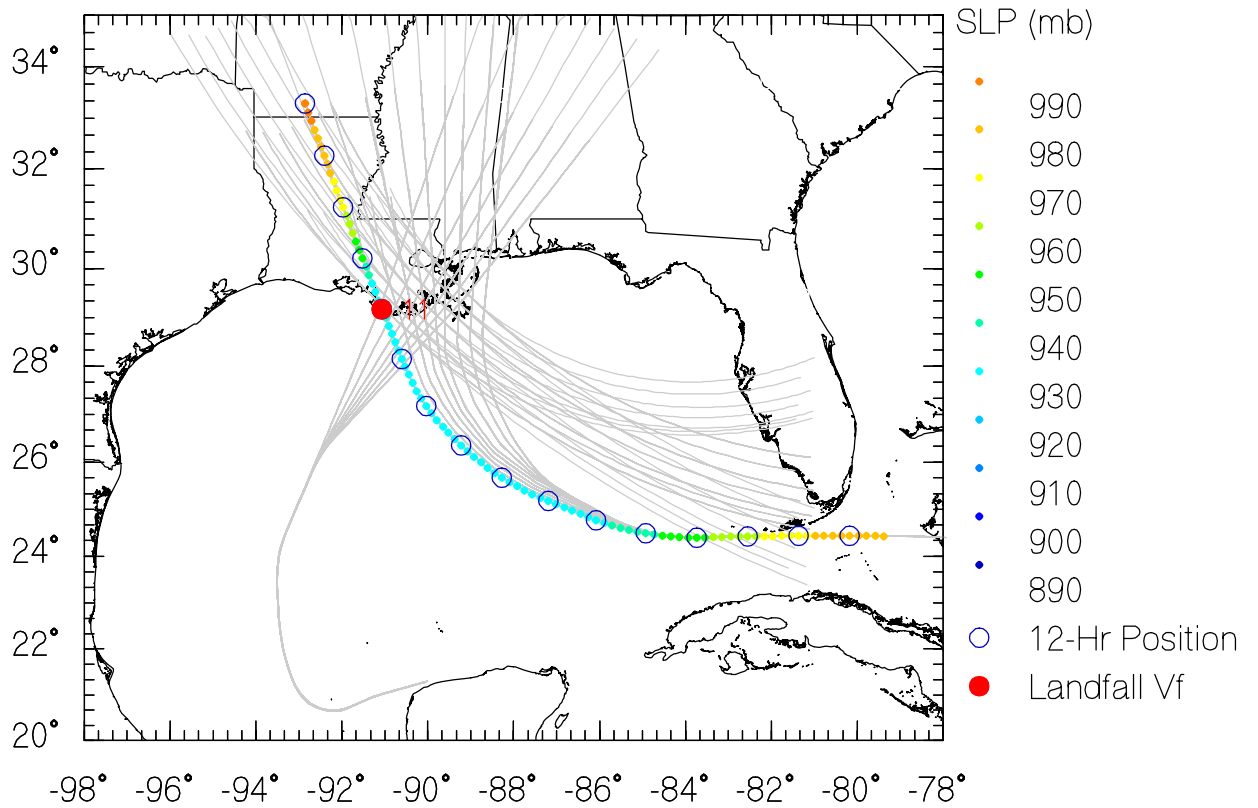

JRUN005 Data

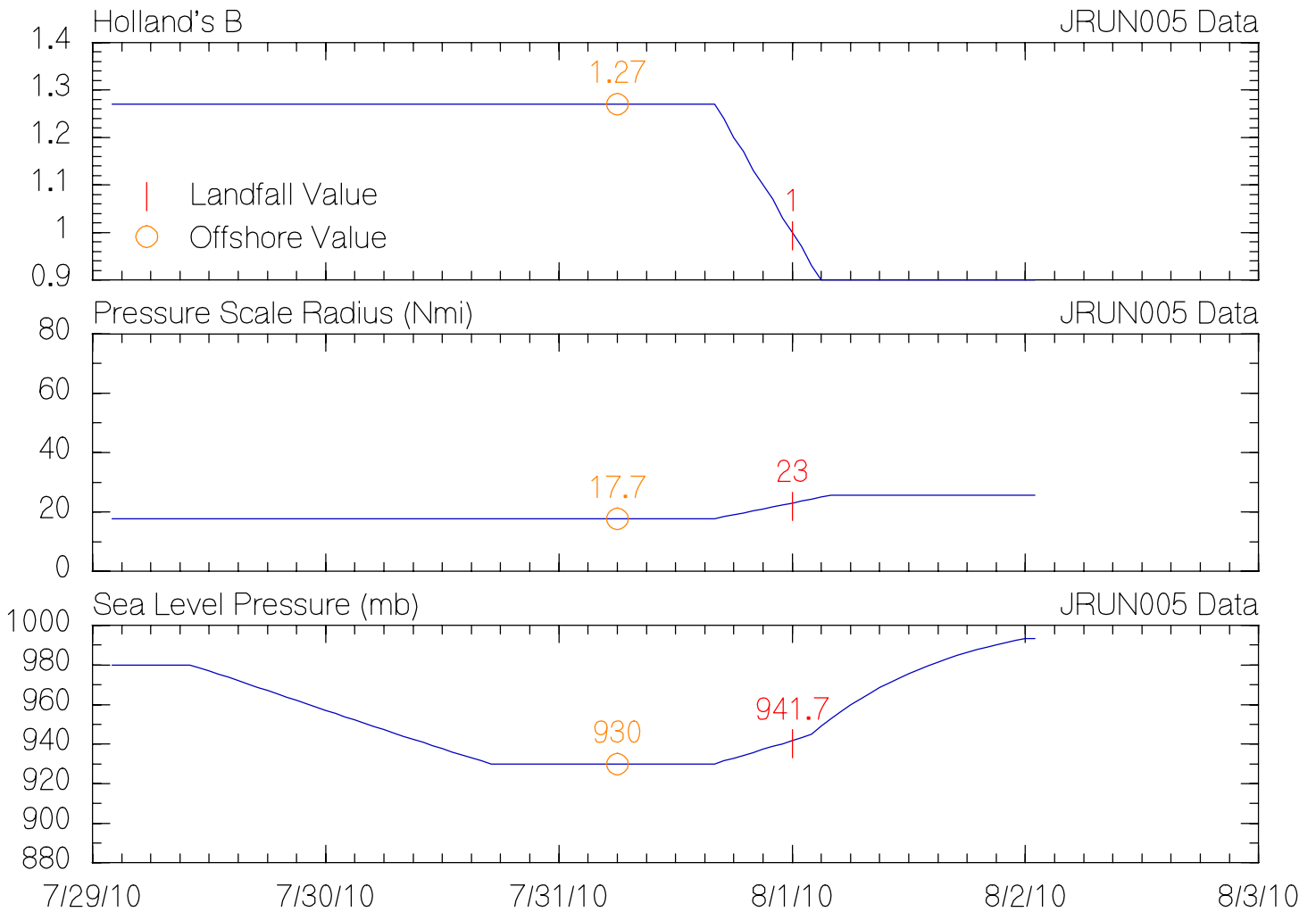
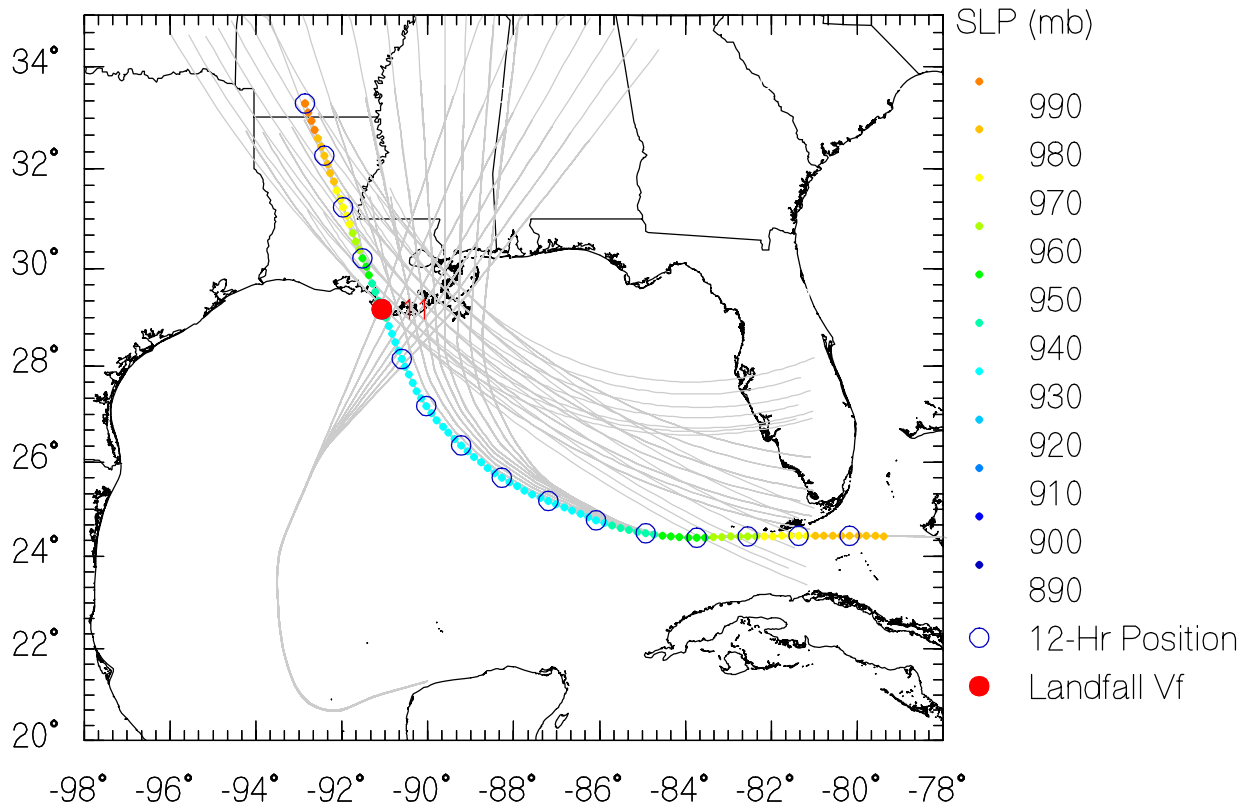

JRUN006 Data

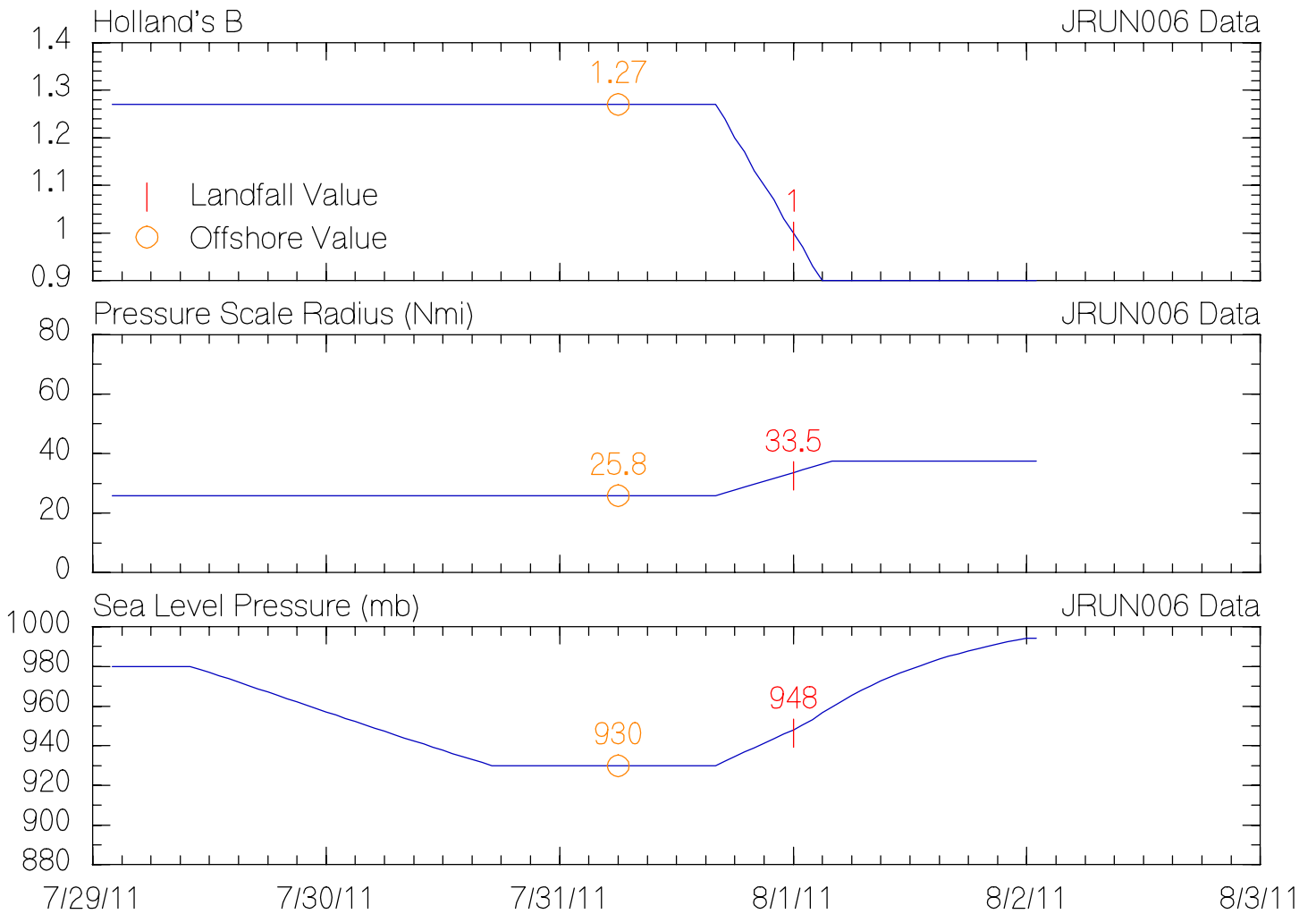
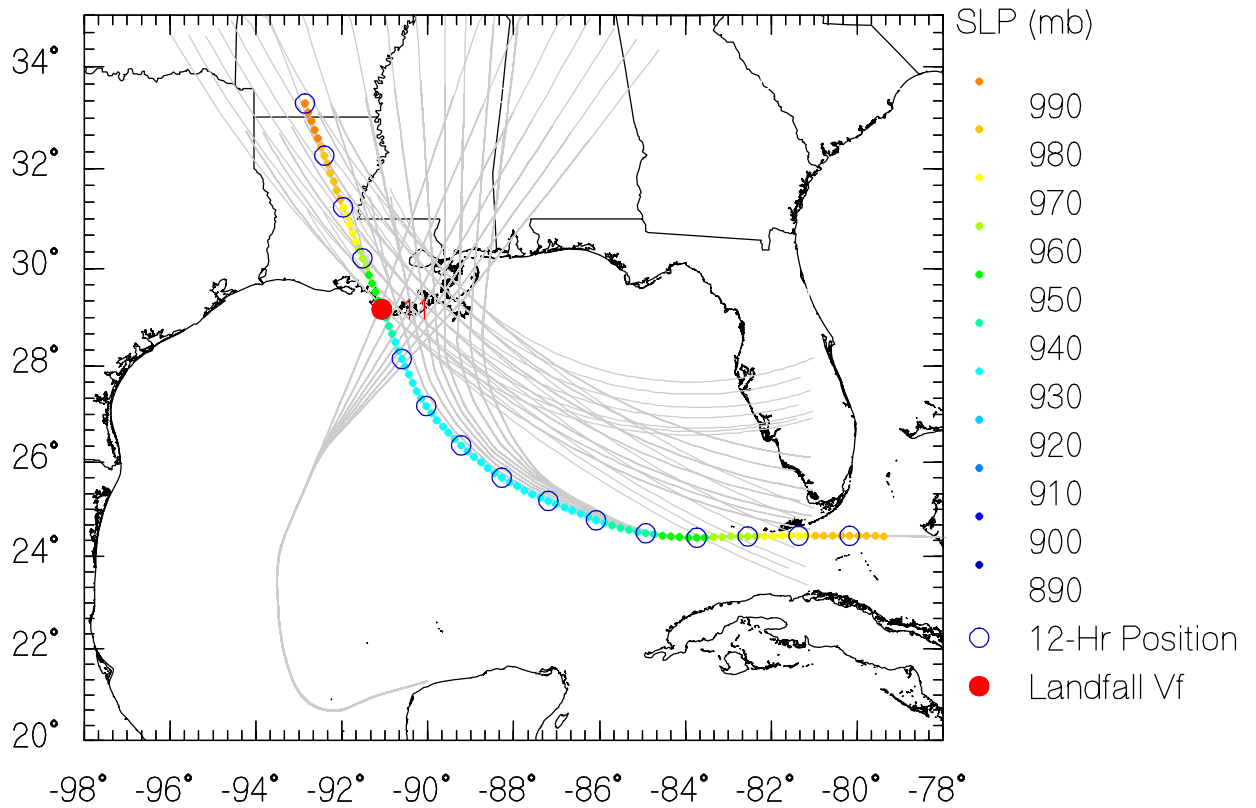

JRUN007 Data

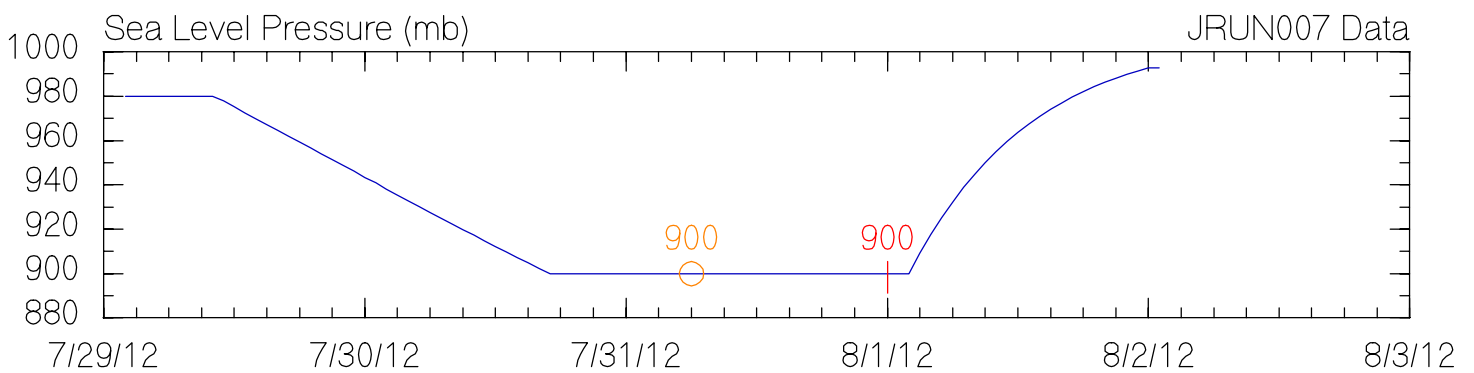
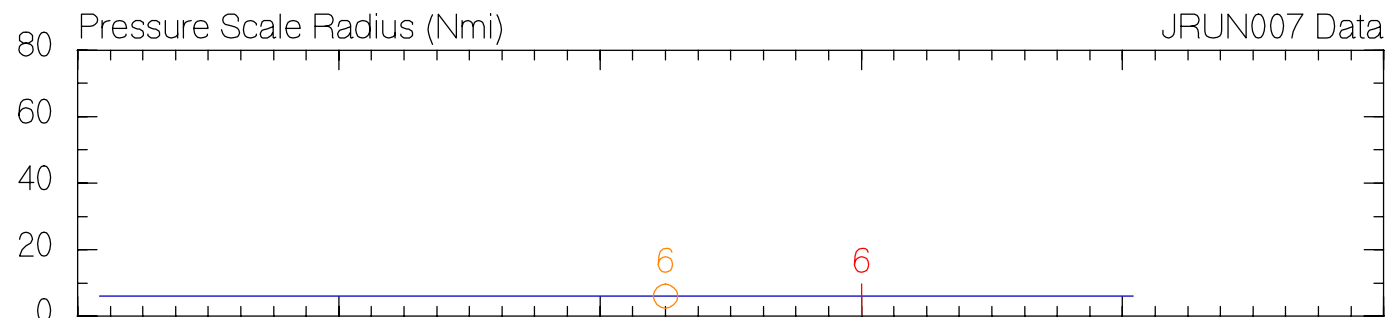
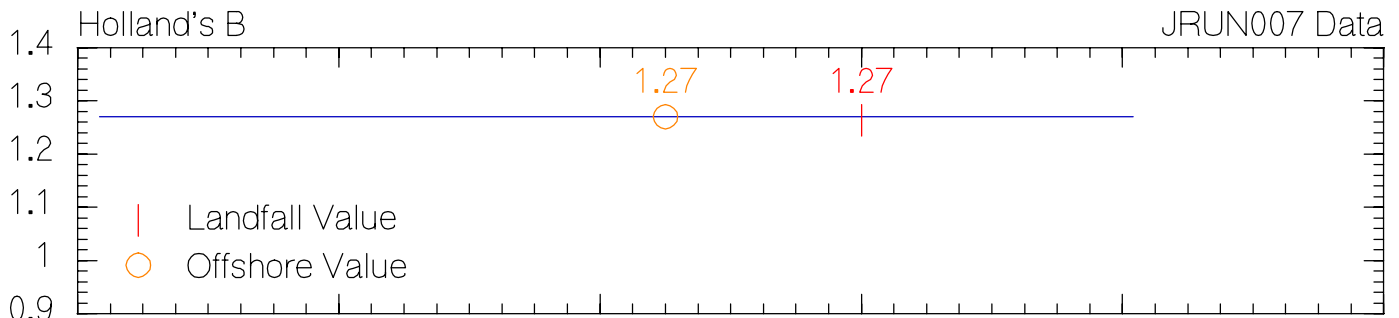
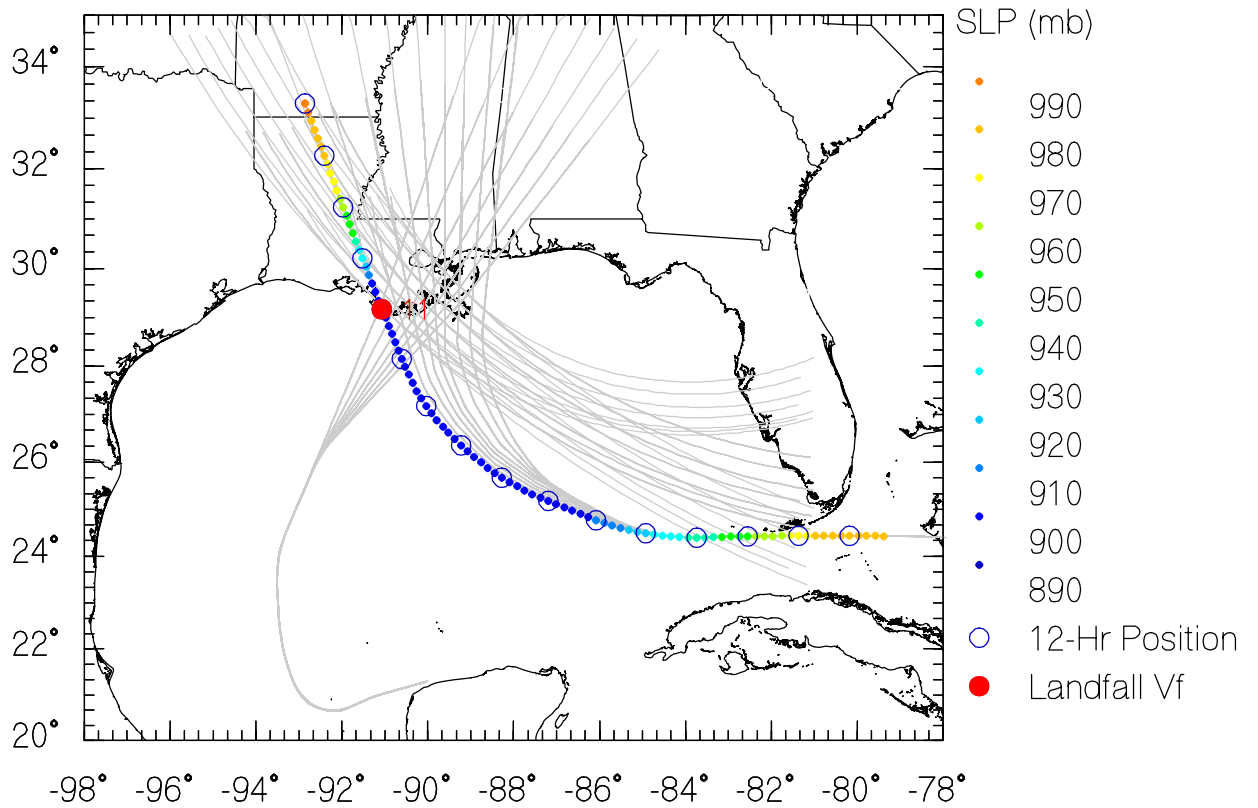

JRUN008 Data

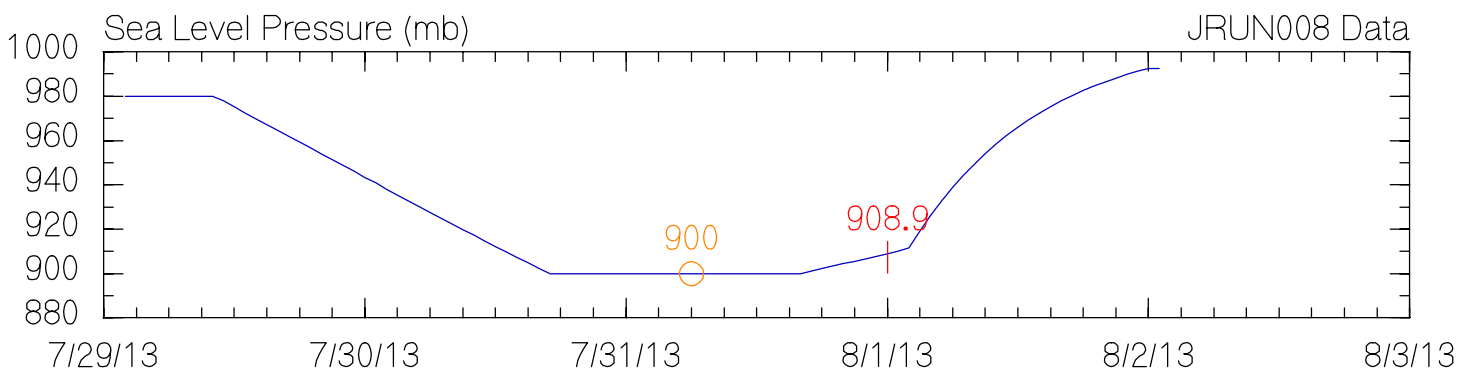
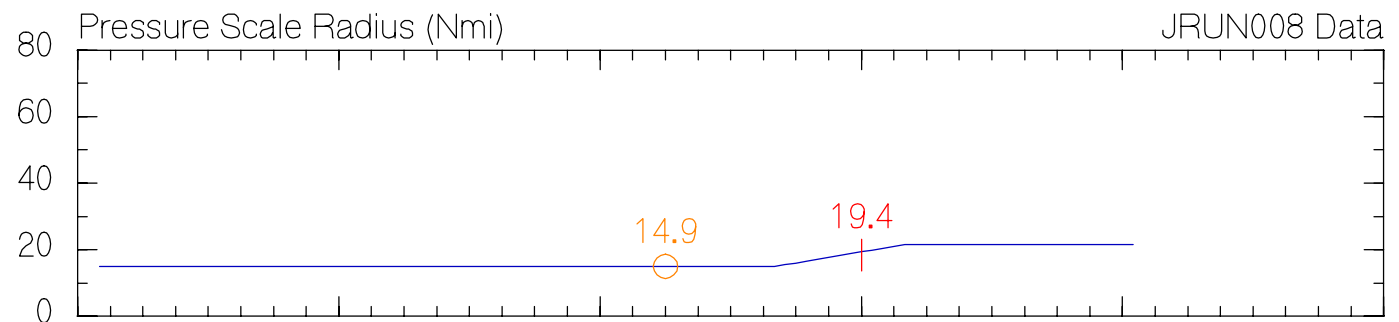
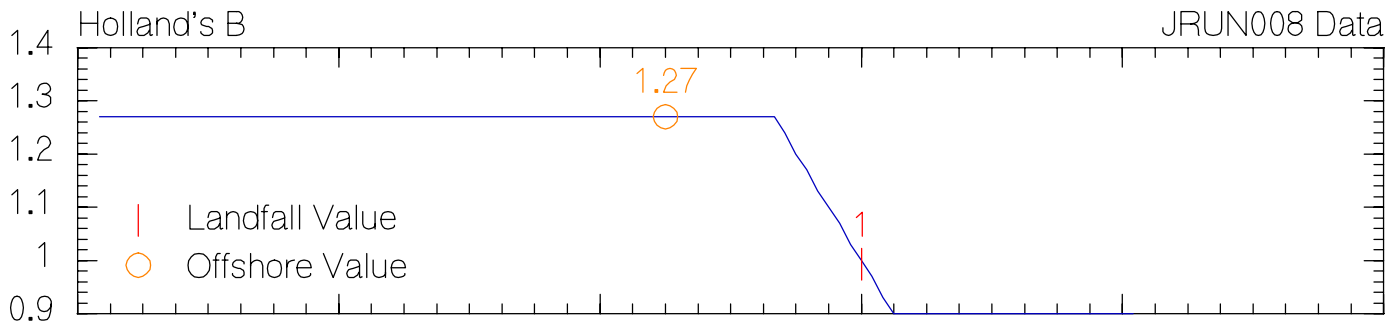
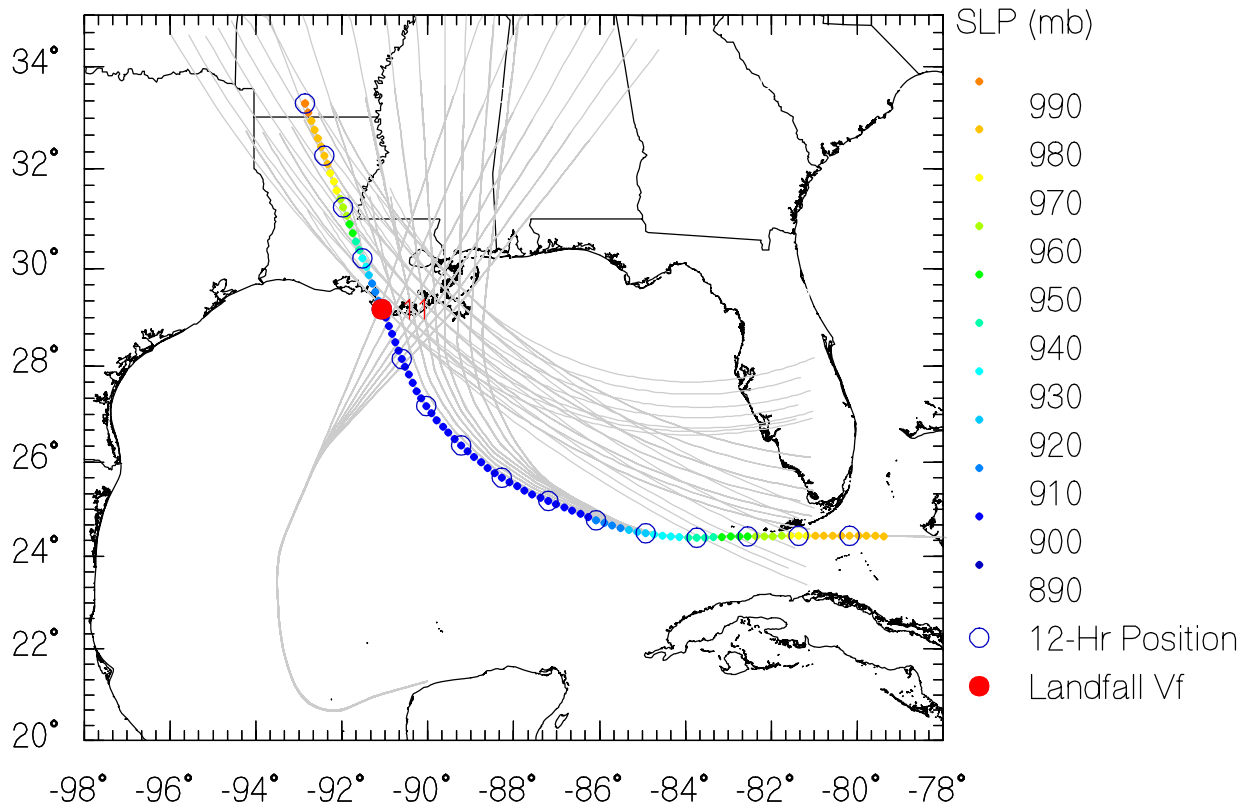

JRUN009 Data

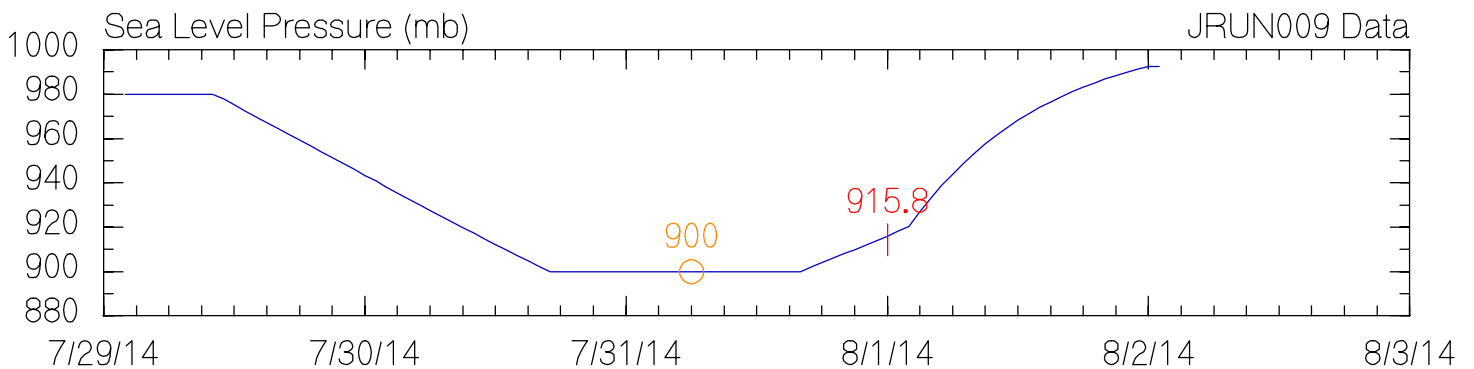
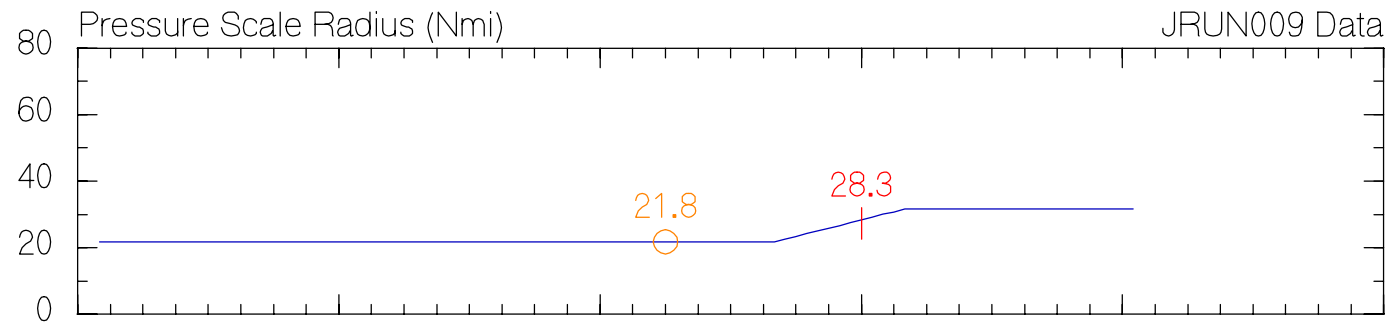
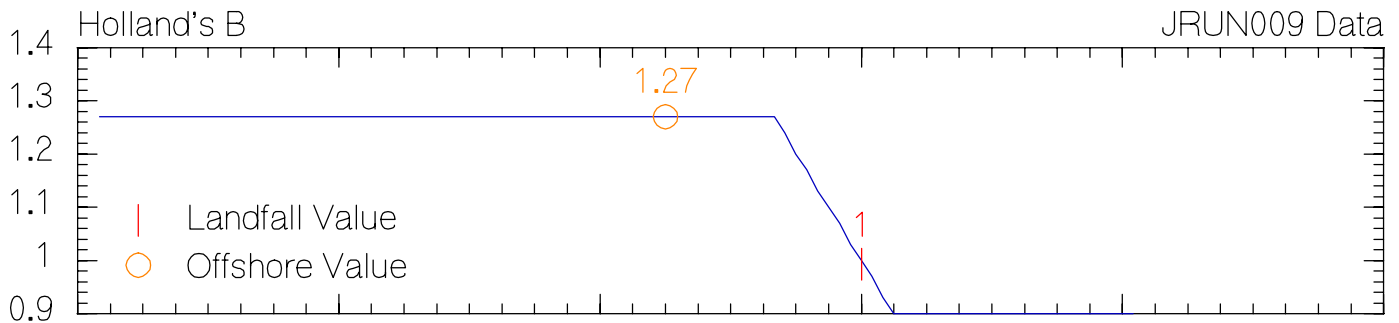
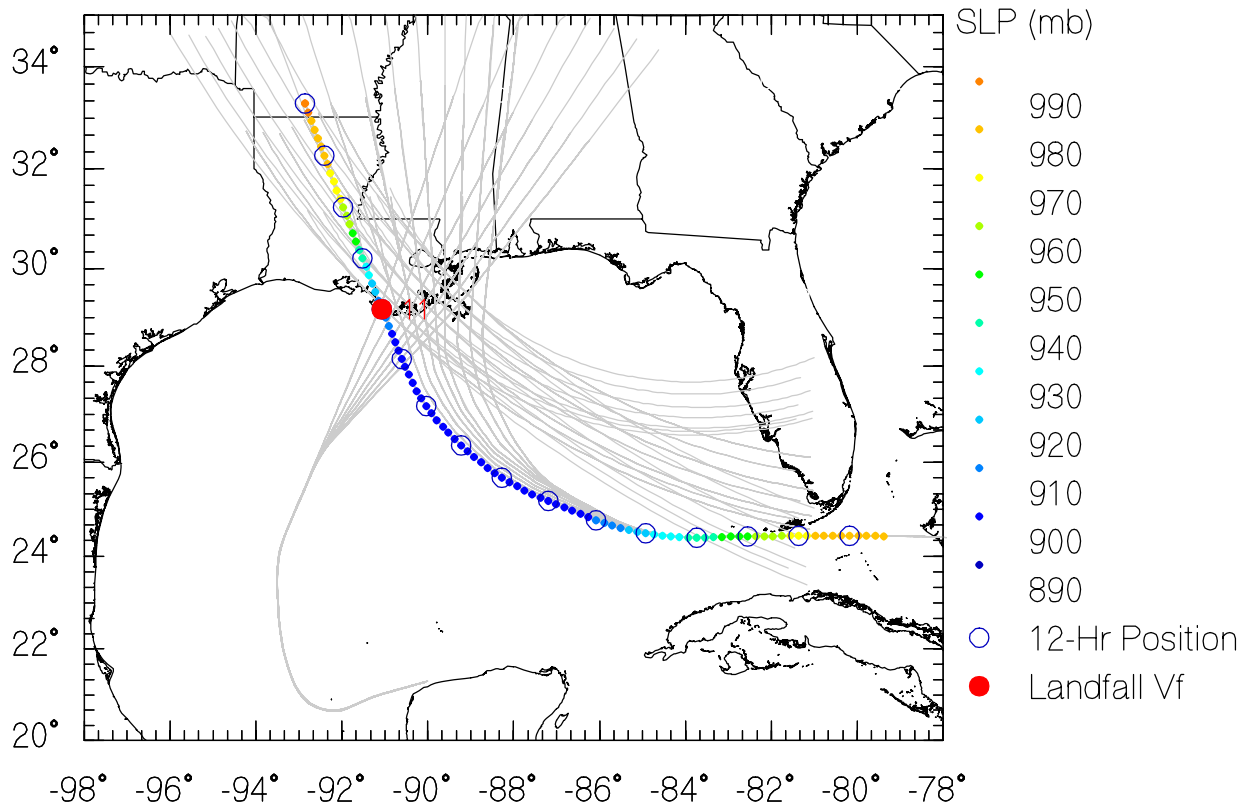

JRUN010 Data

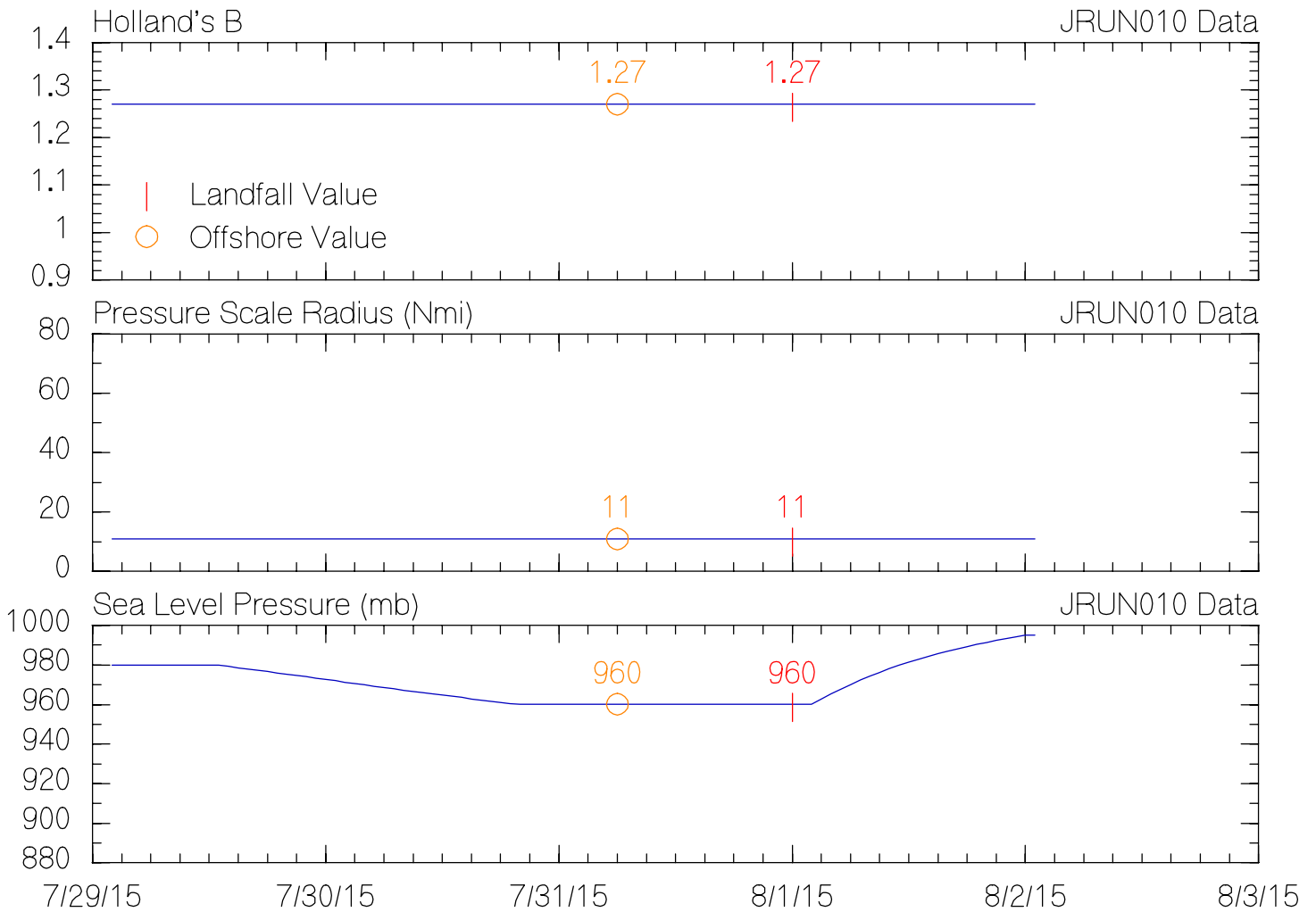
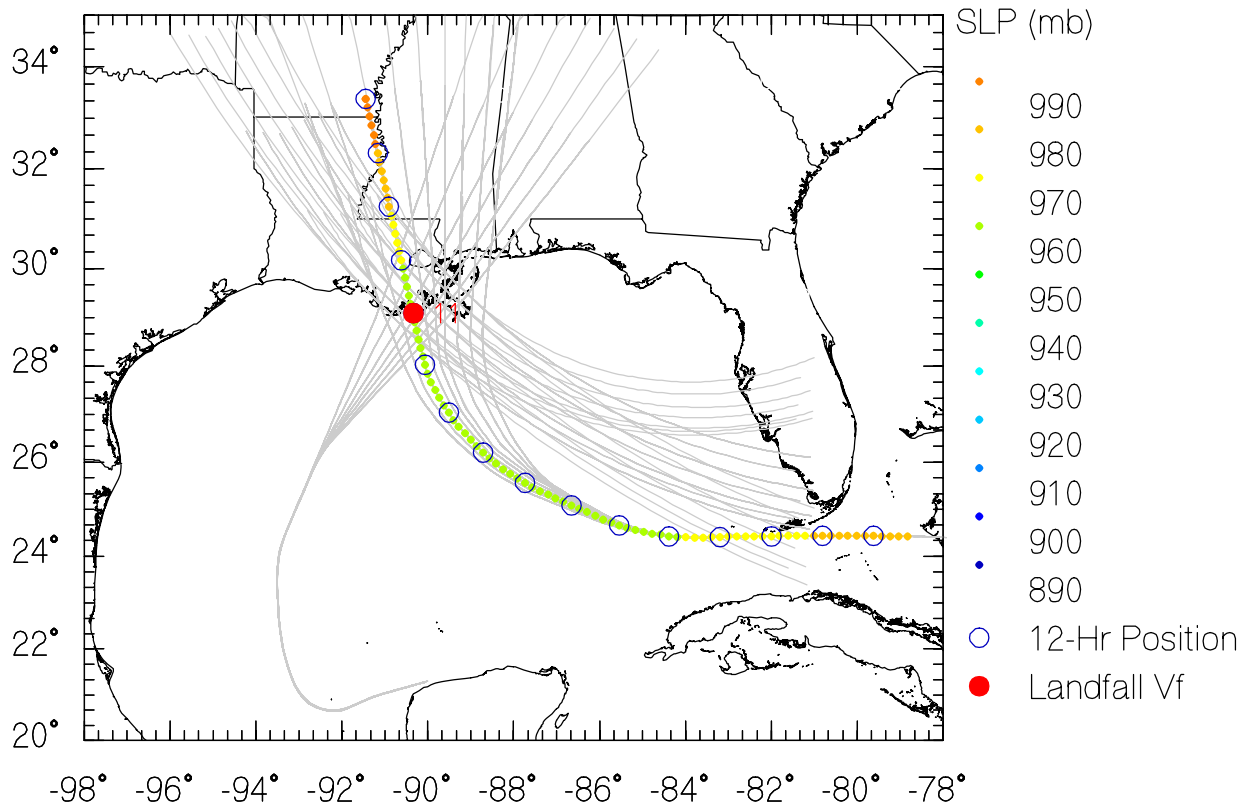

JRUN011 Data

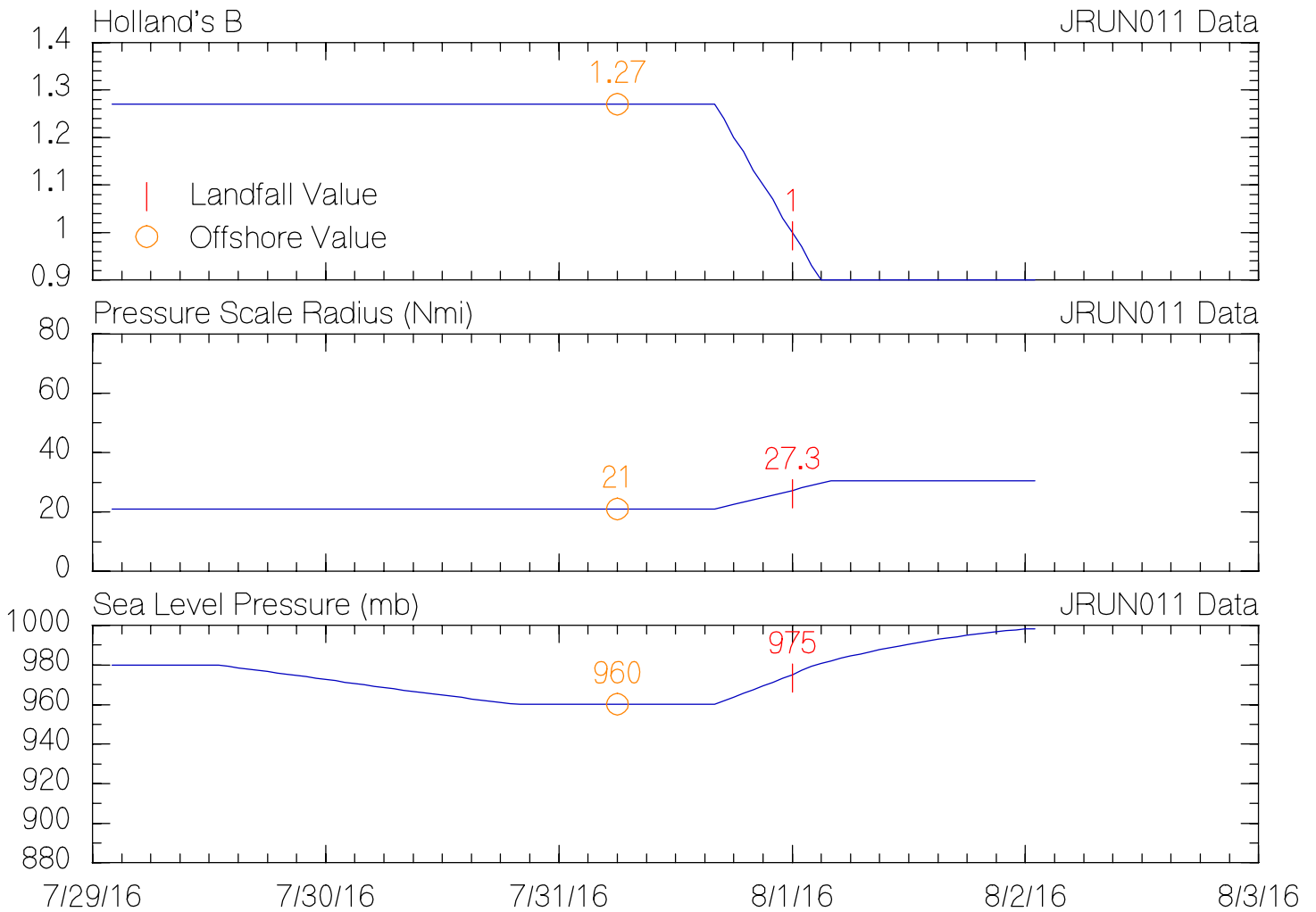
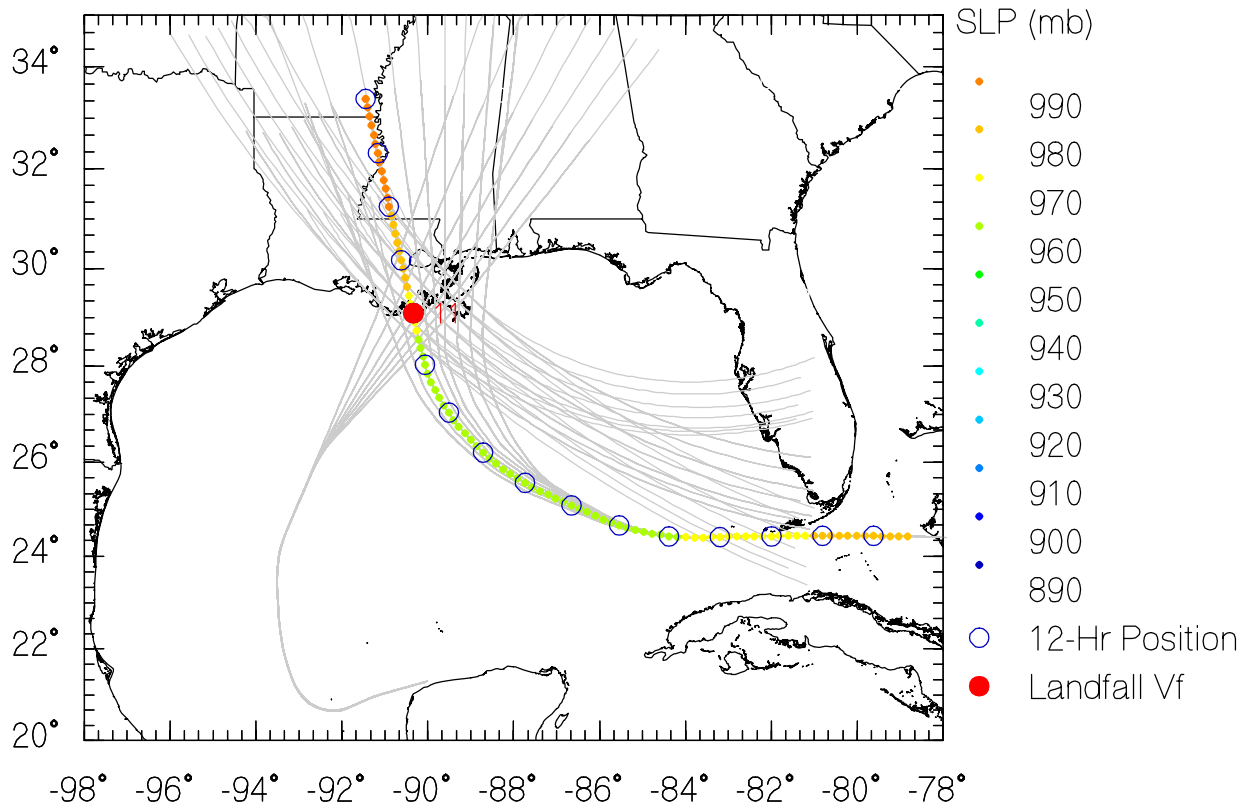

JRUN012 Data

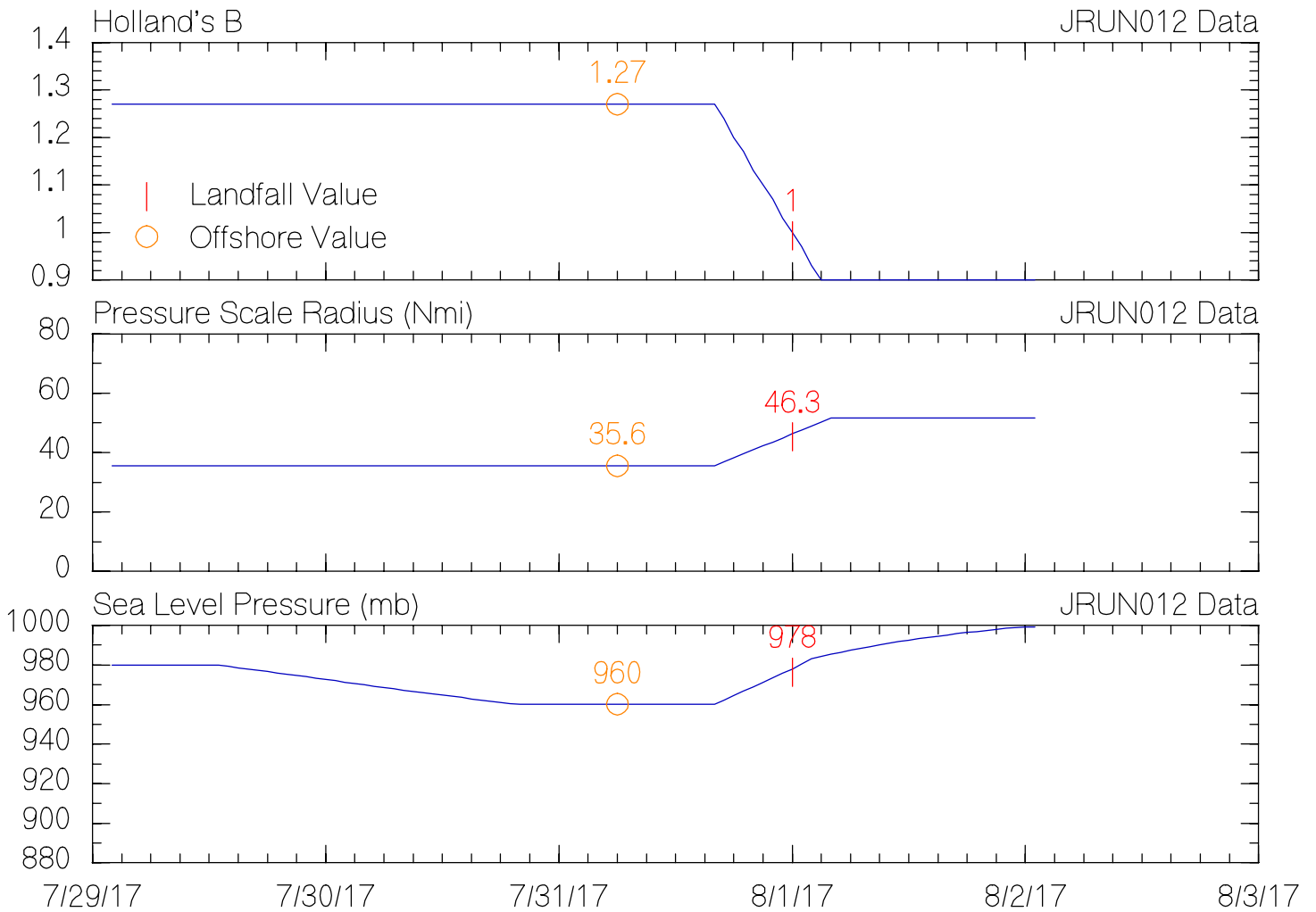
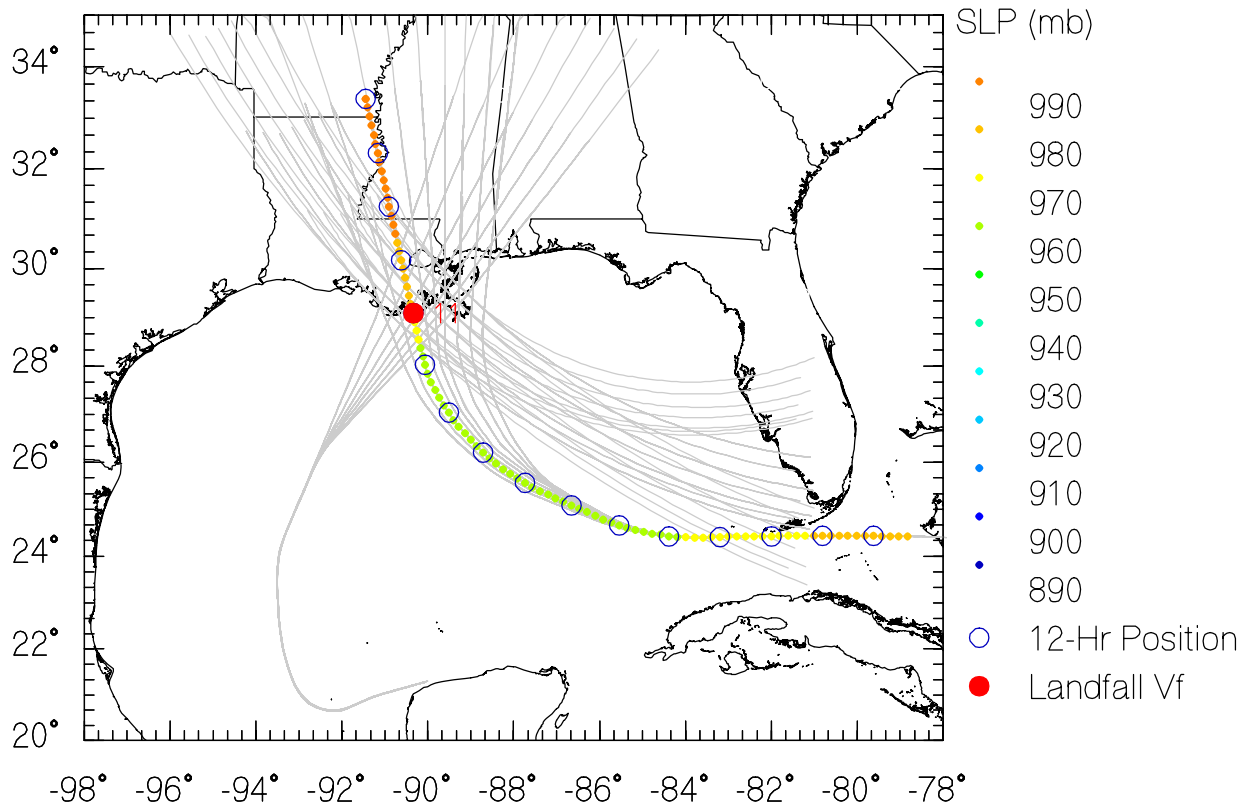

JRUN013 Data

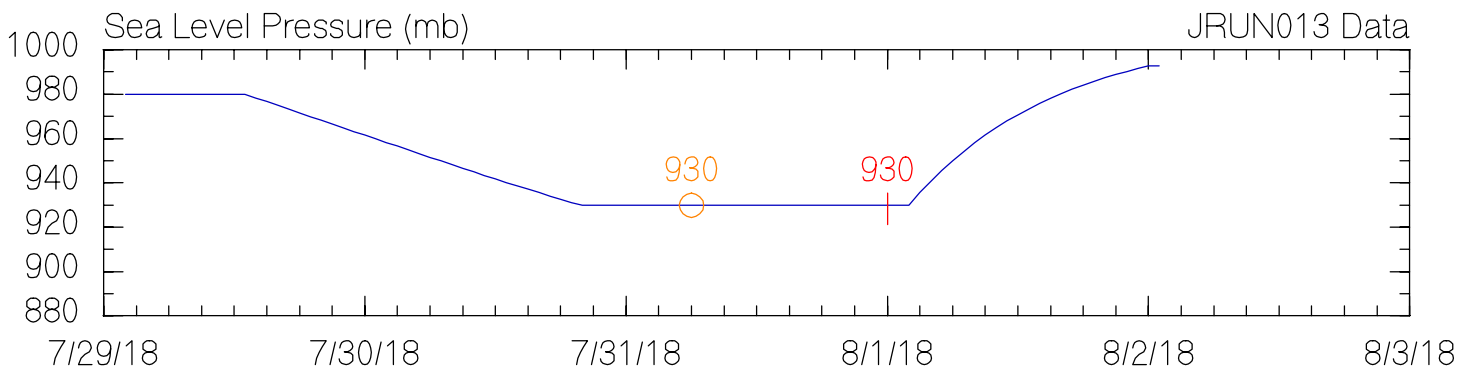
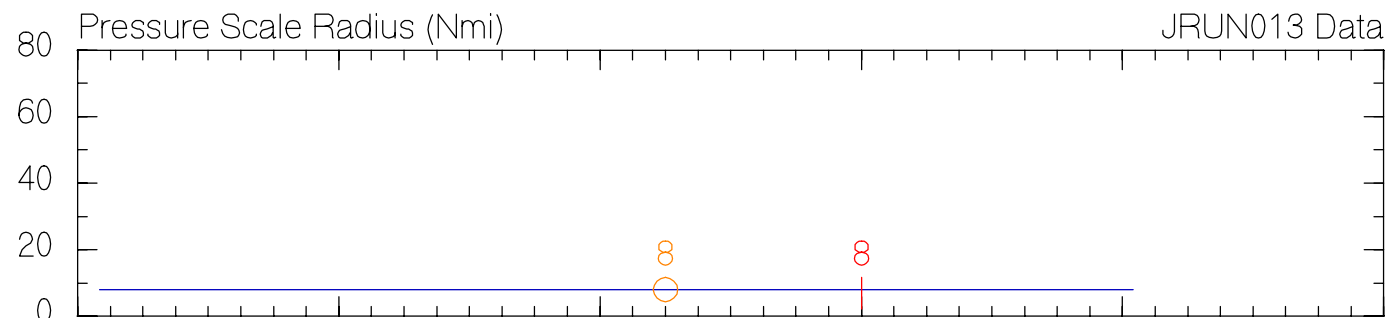
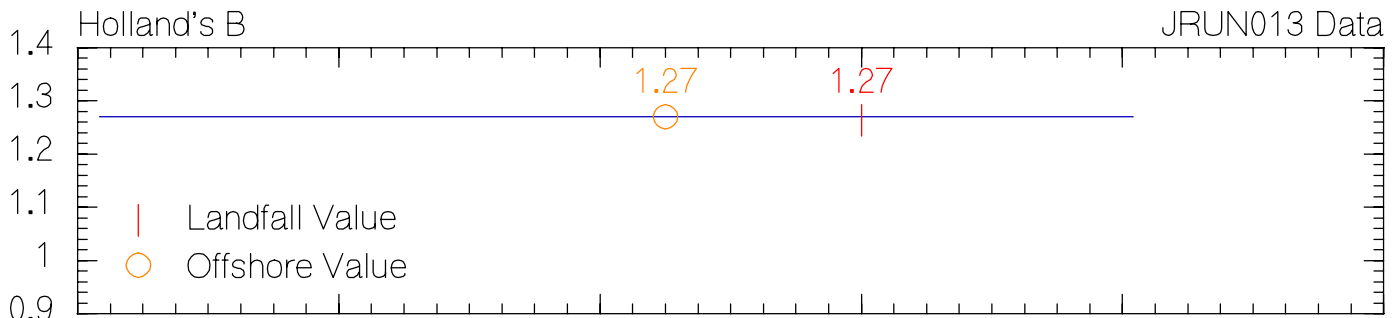
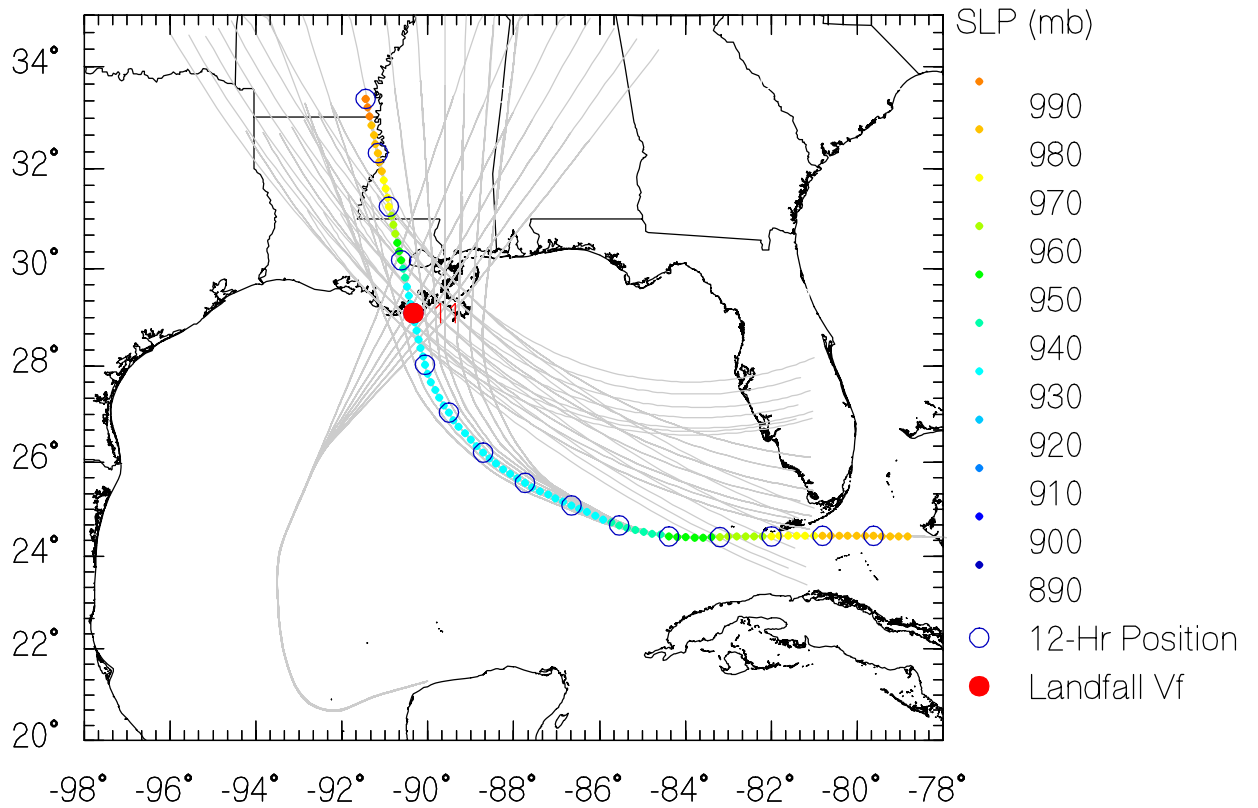

JRUN014 Data

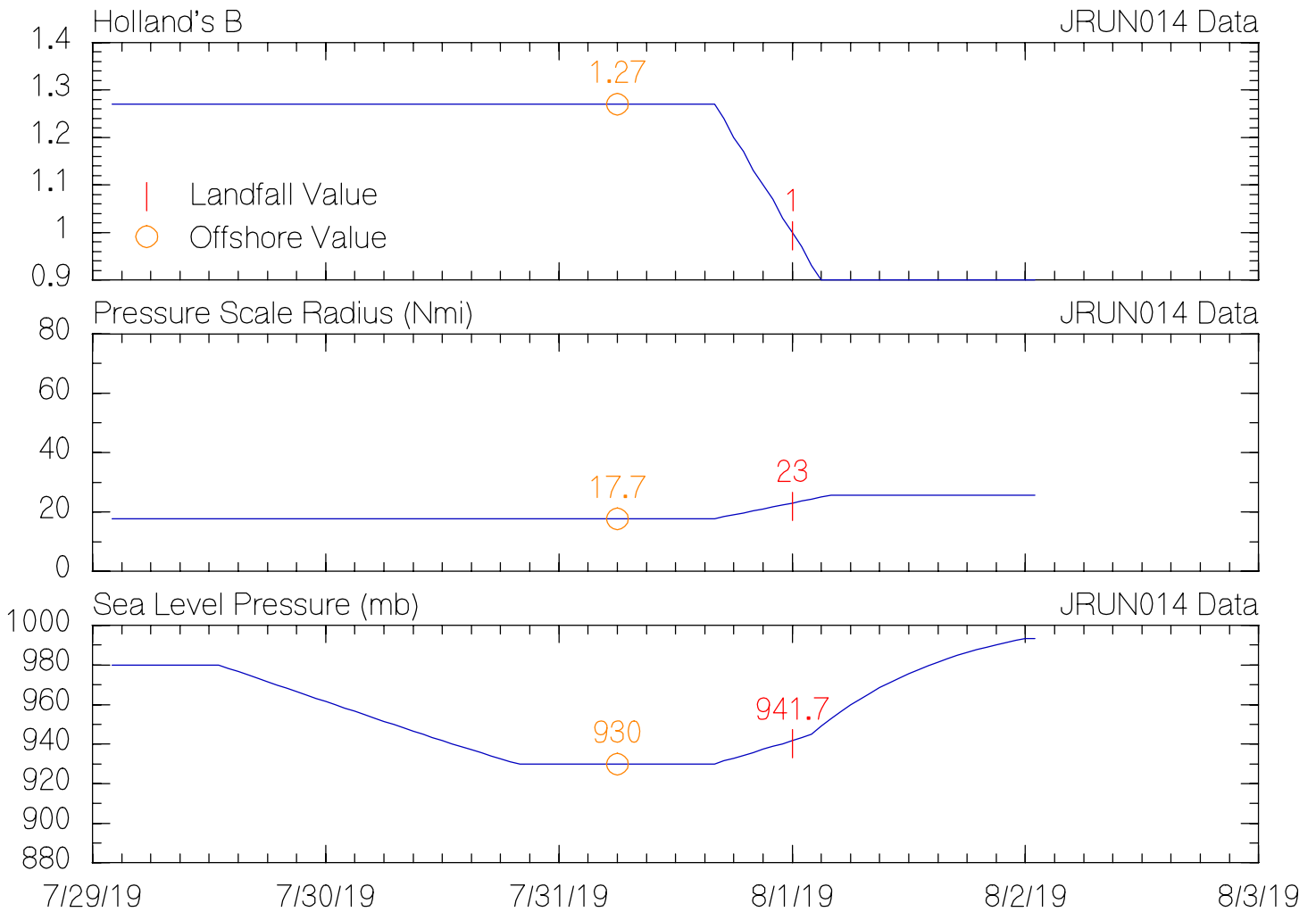
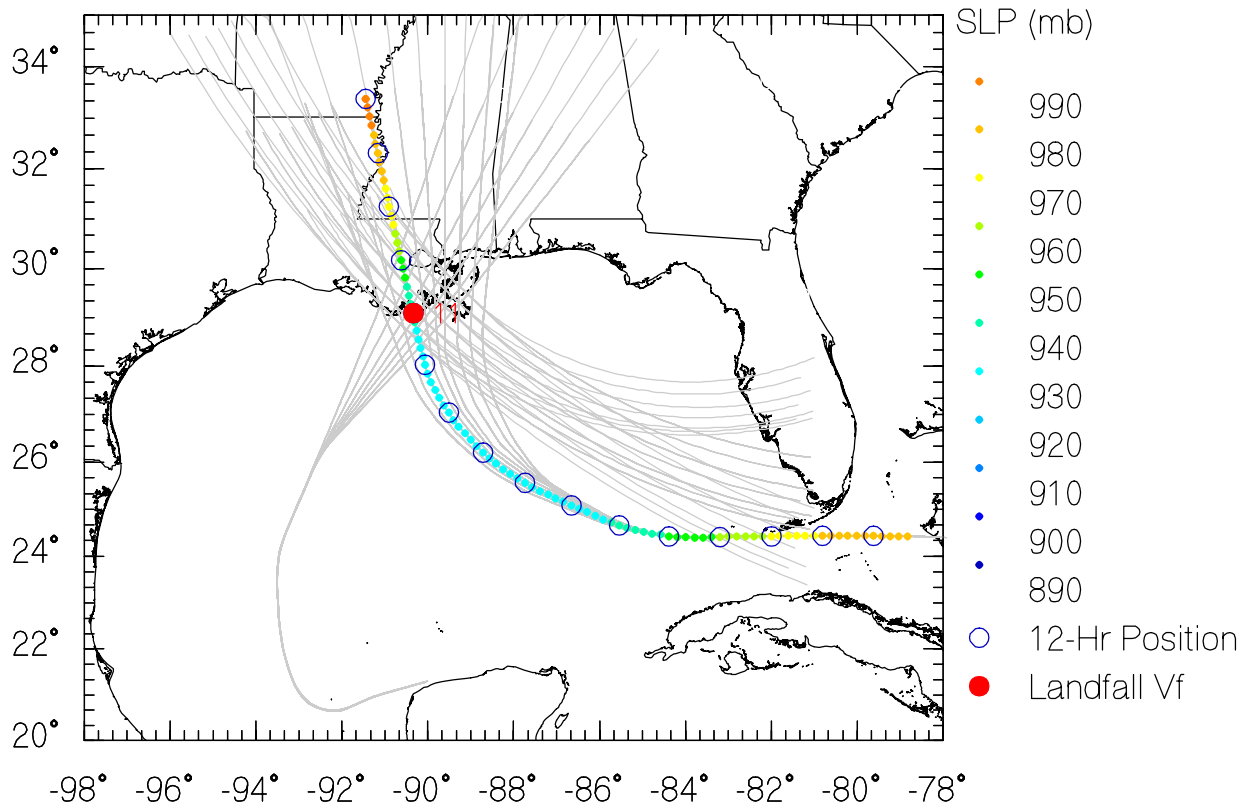

JRUN015 Data

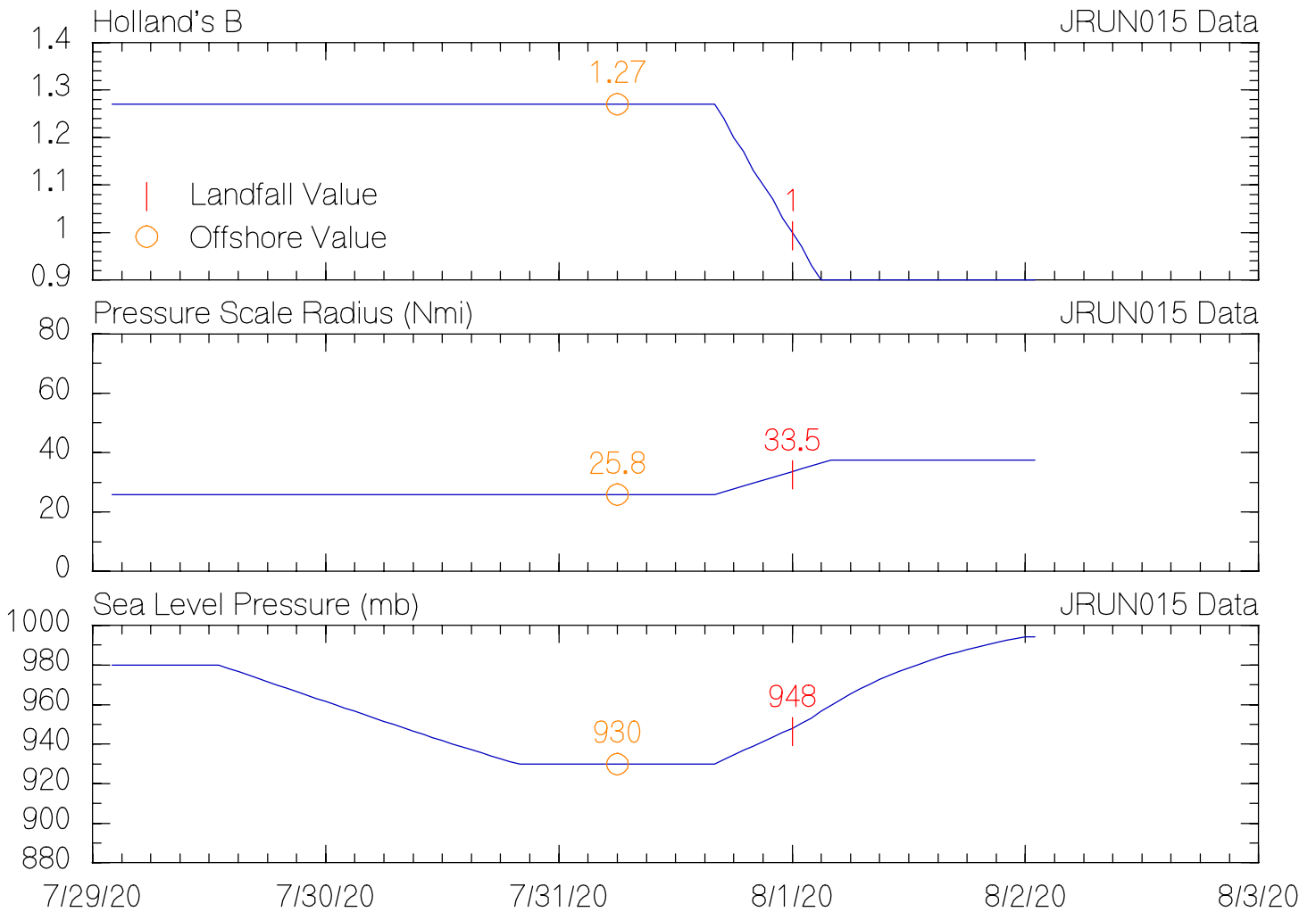
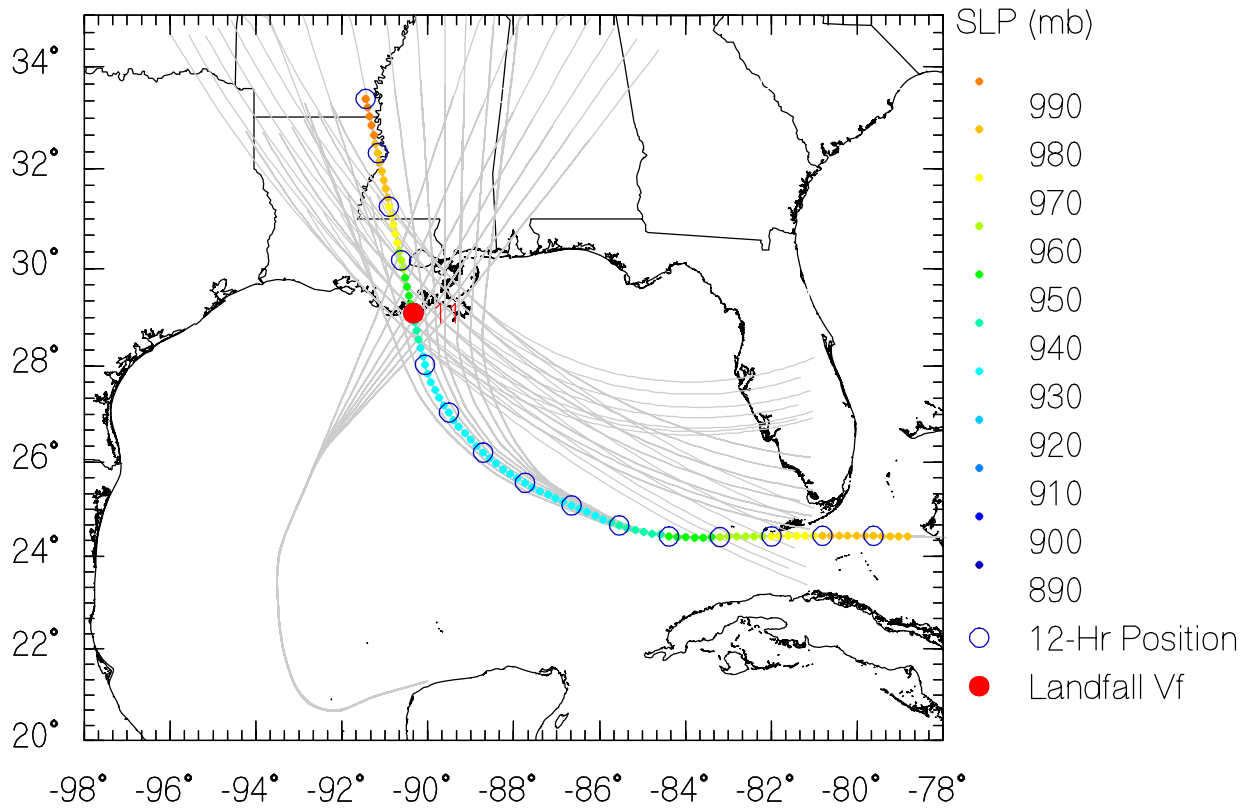

JRUN016 Data

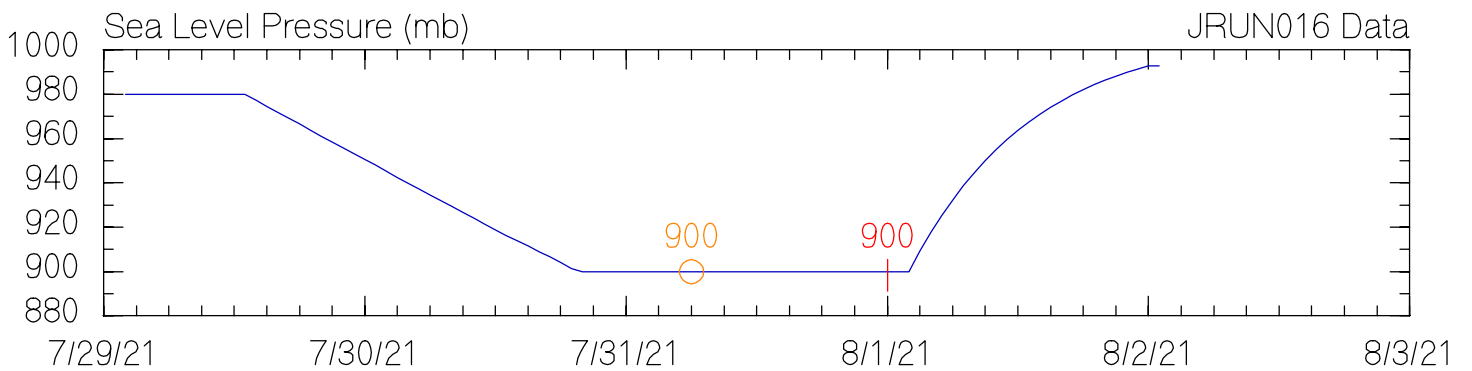
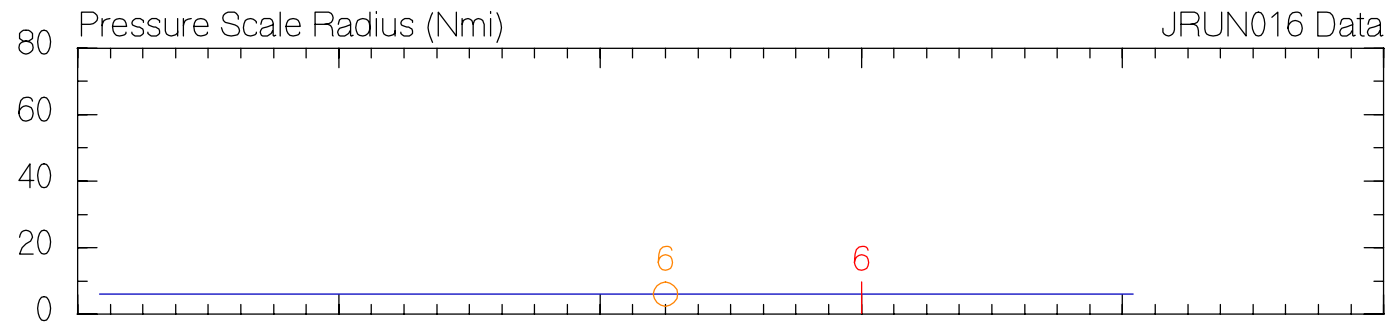
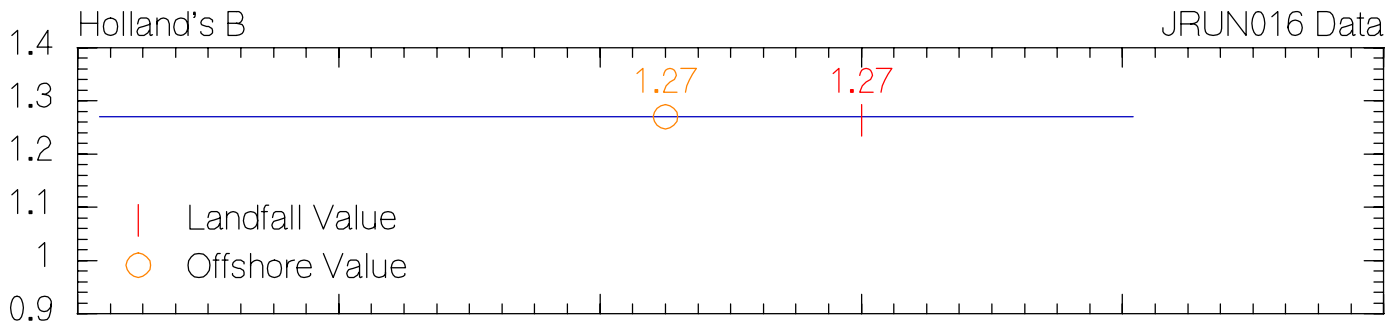
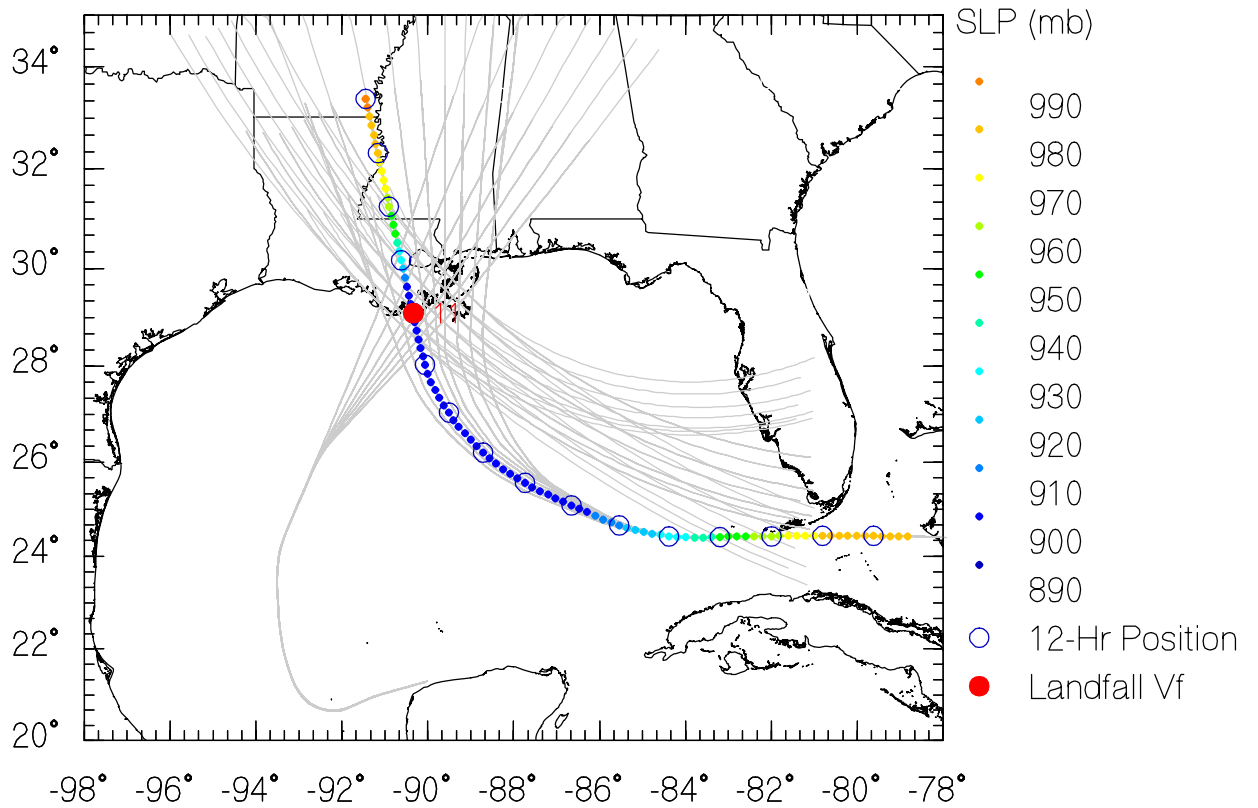

JRUN017 Data

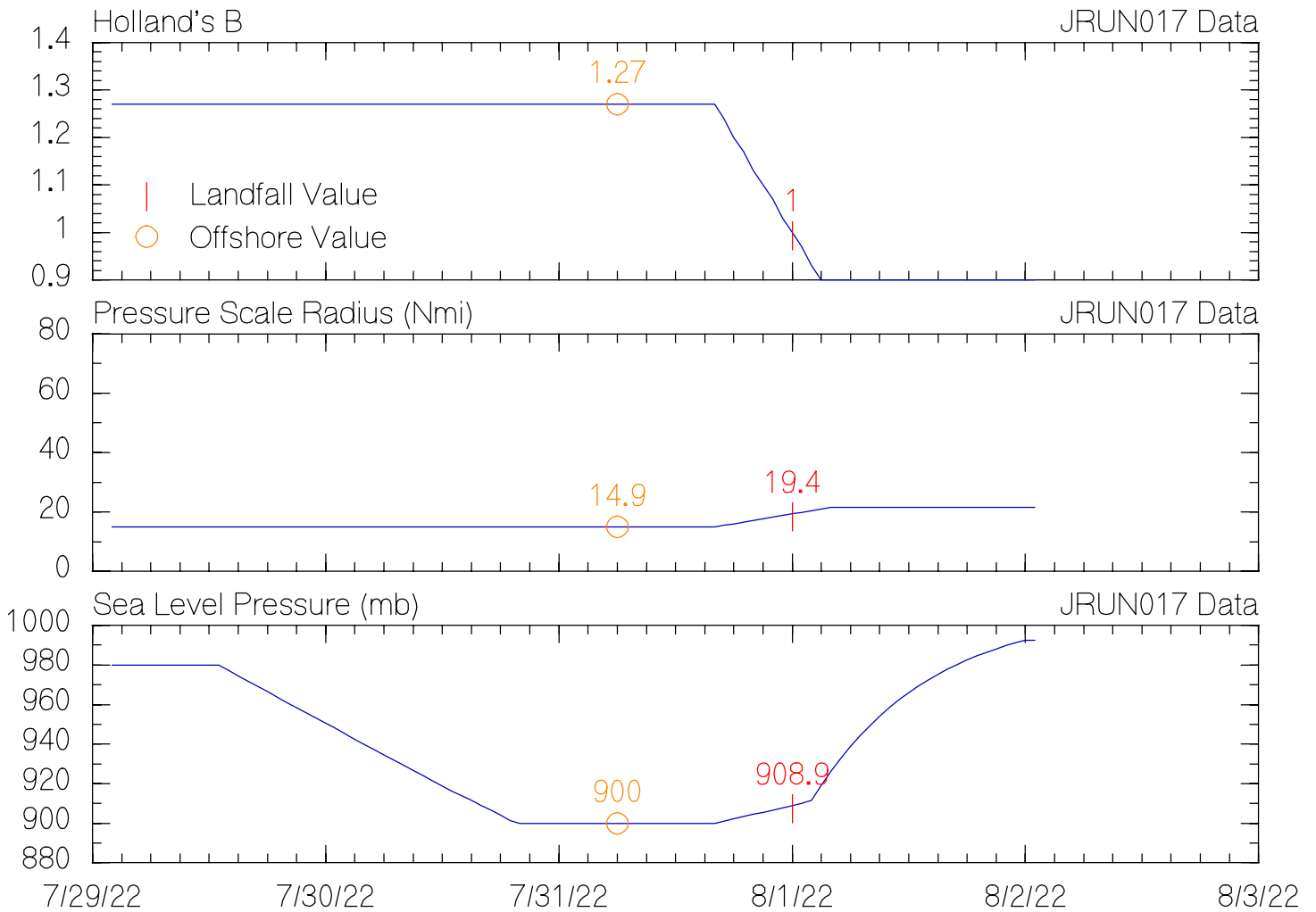
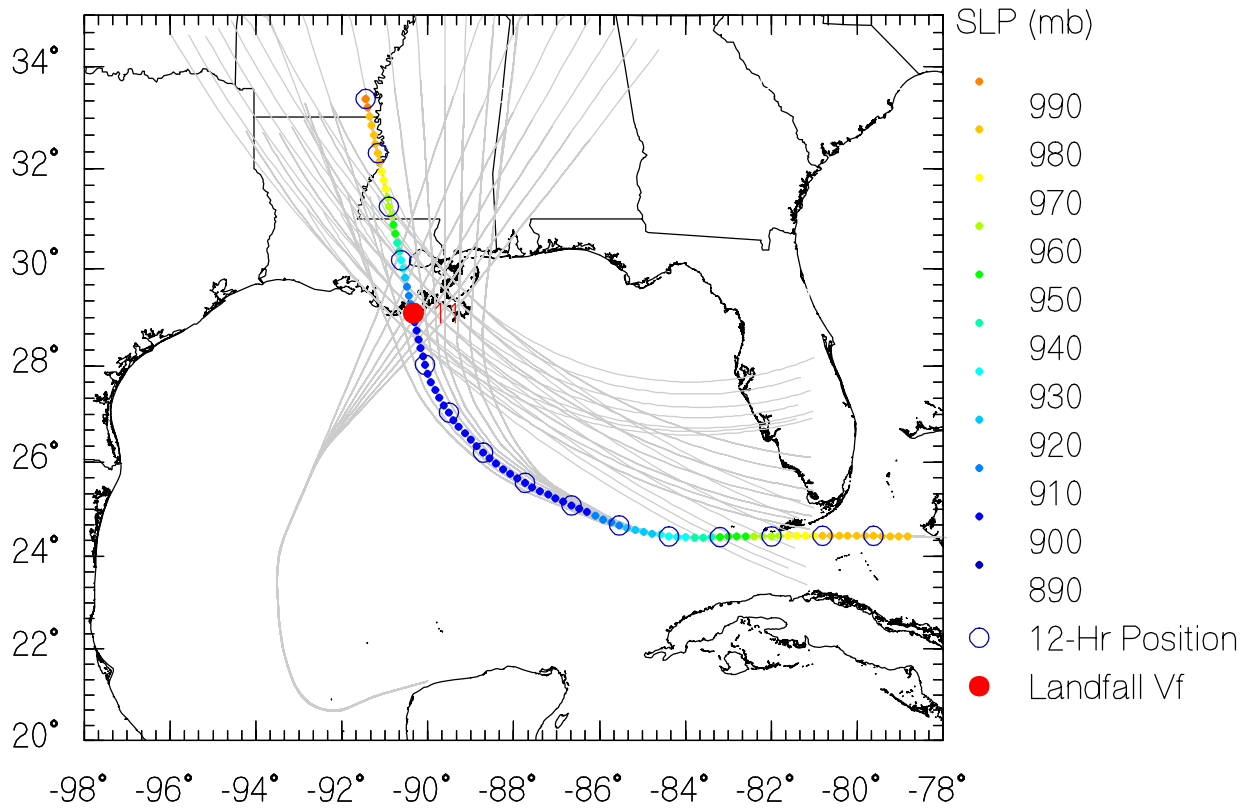

JRUN018 Data

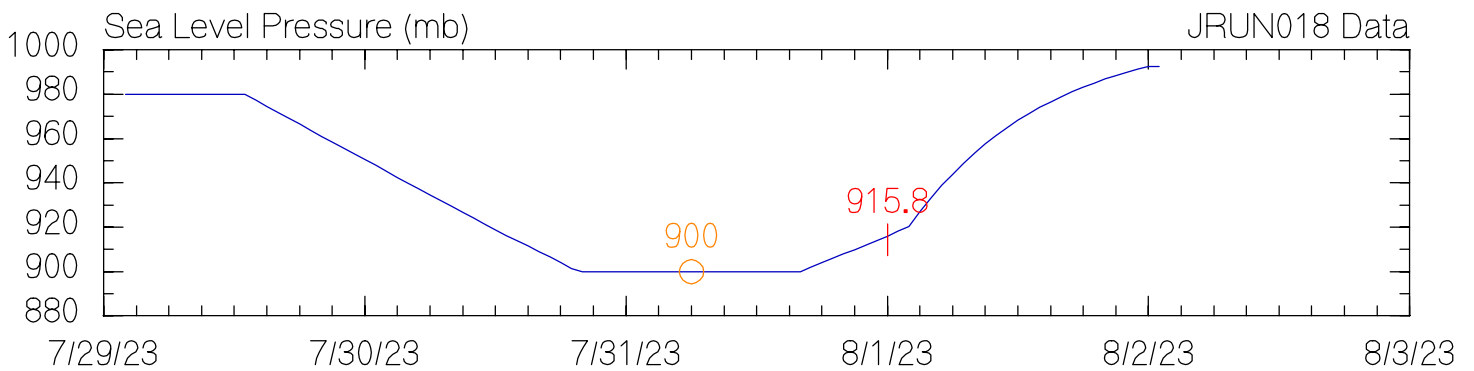
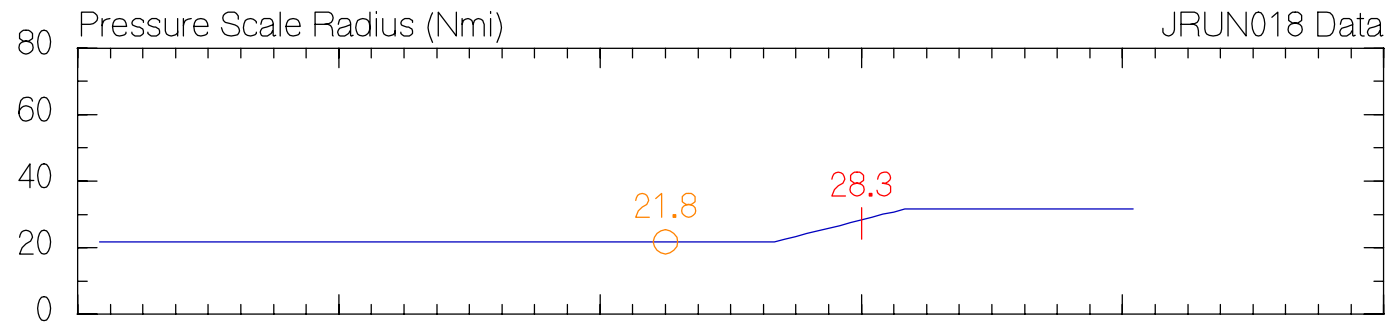
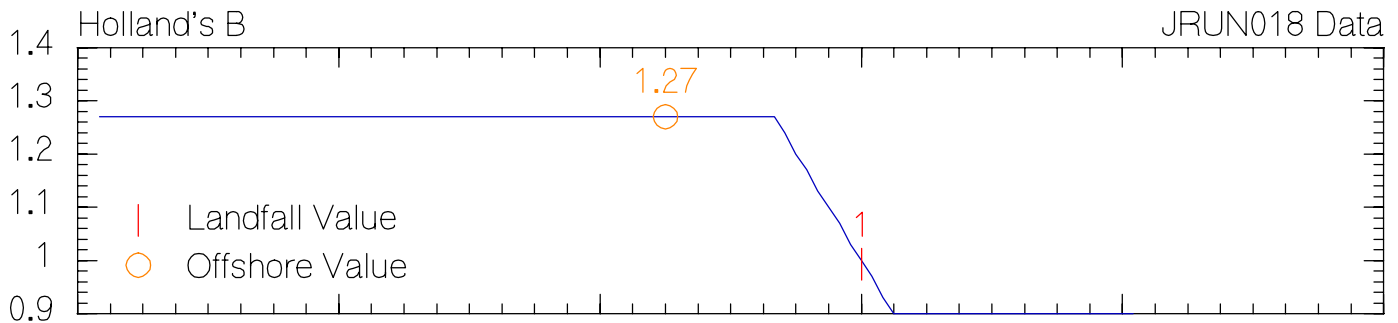
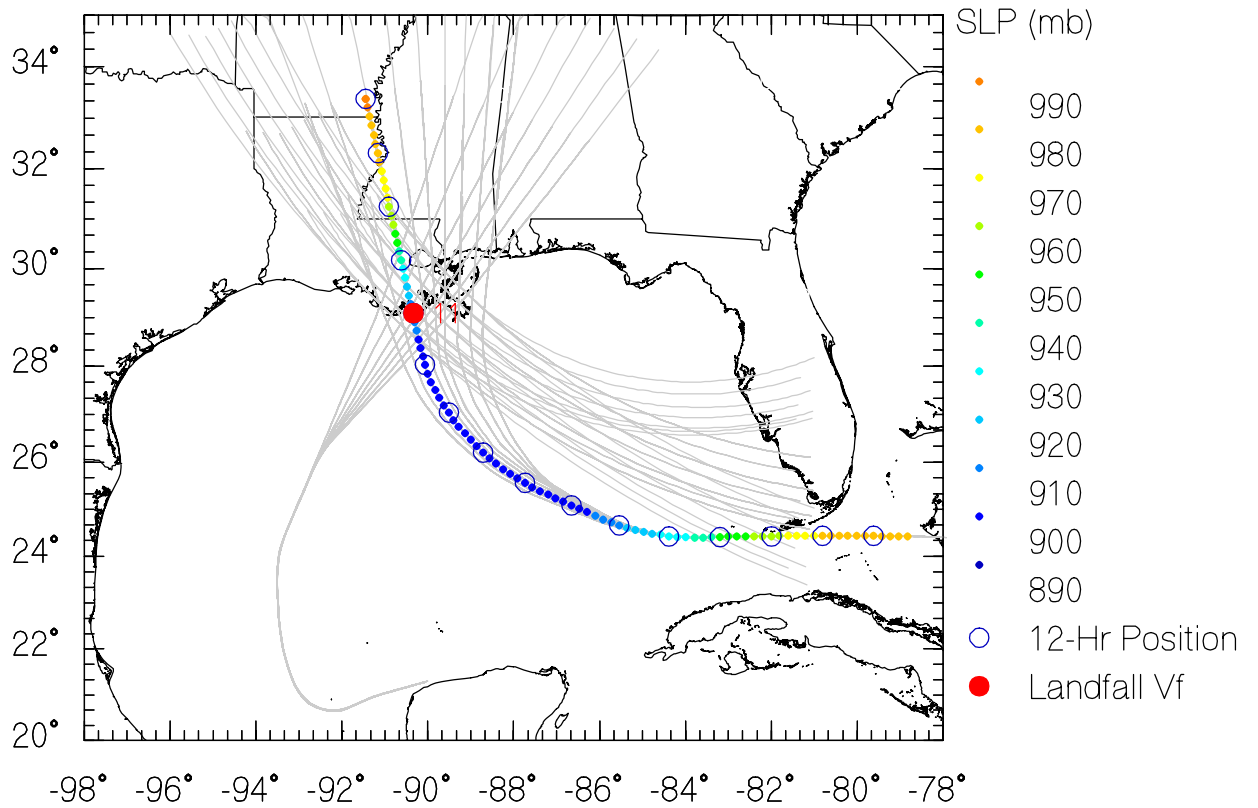

JRUN019 Data

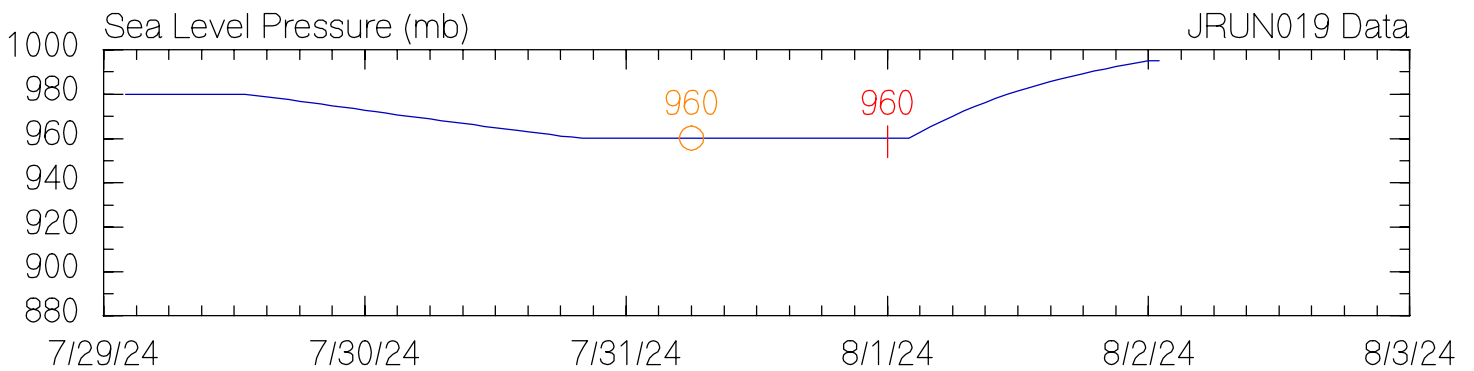
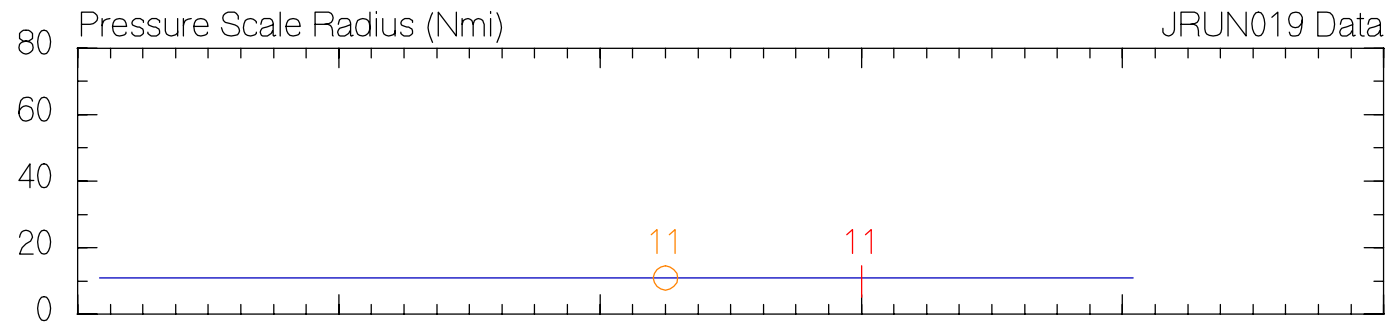
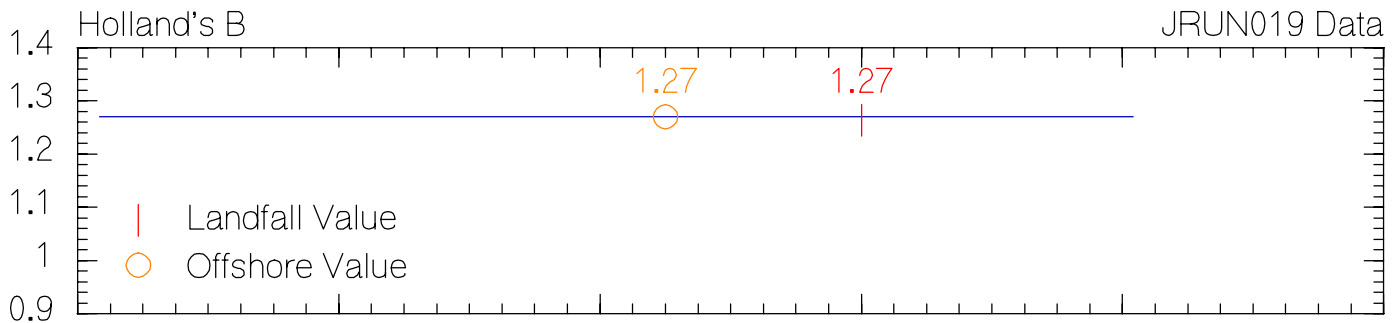
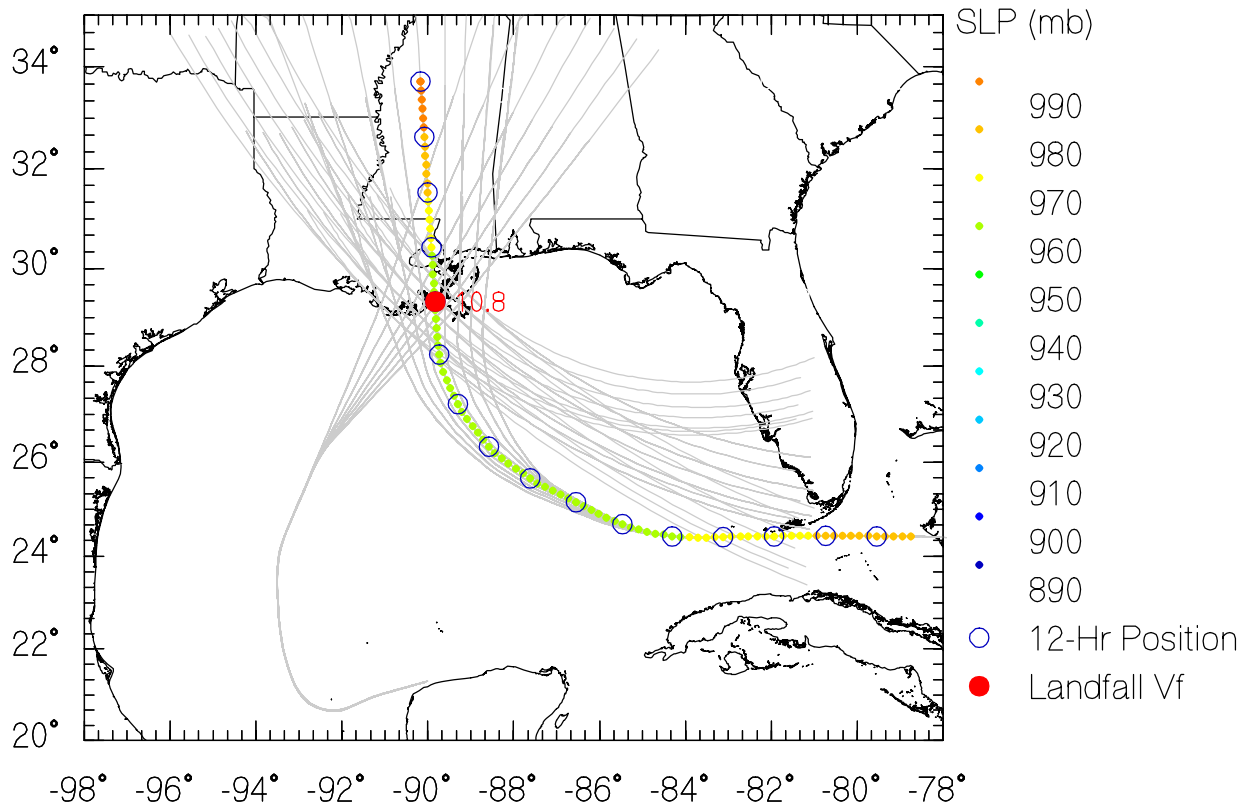

JRUN020 Data

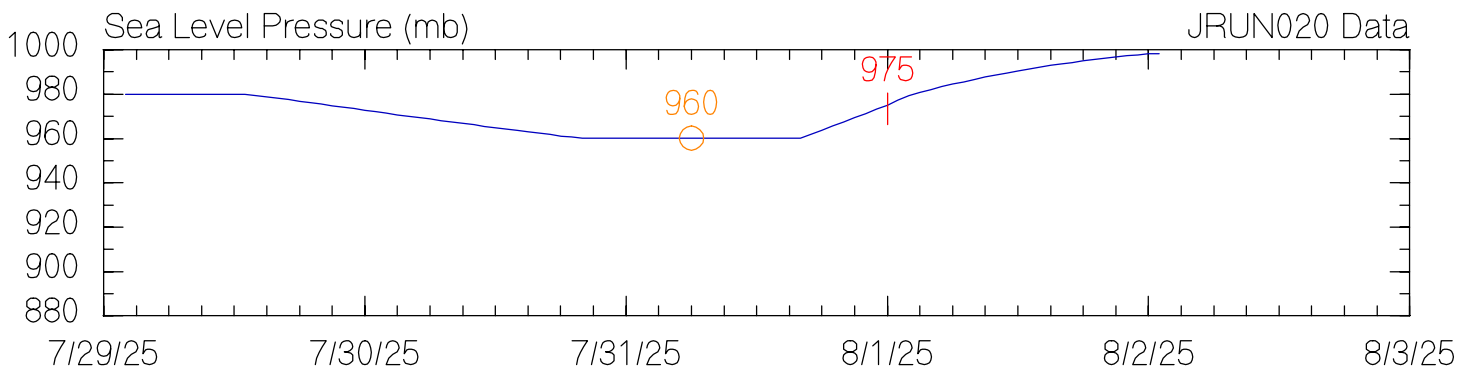
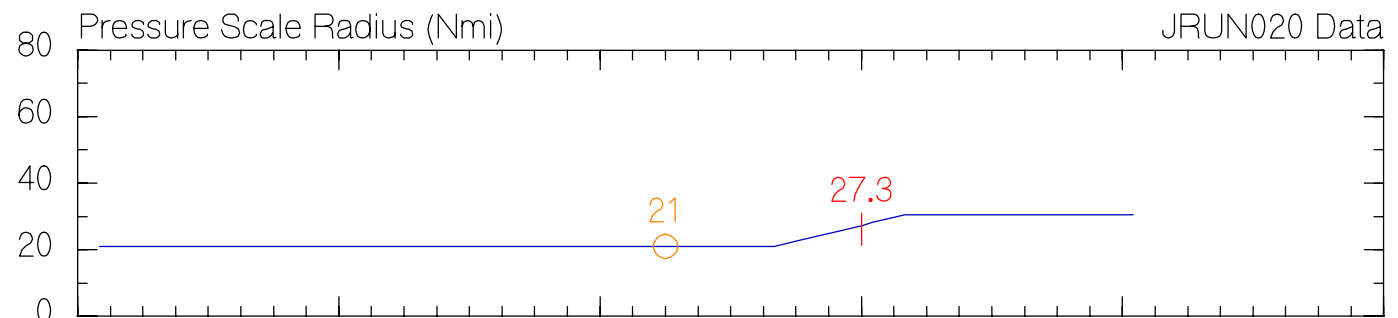
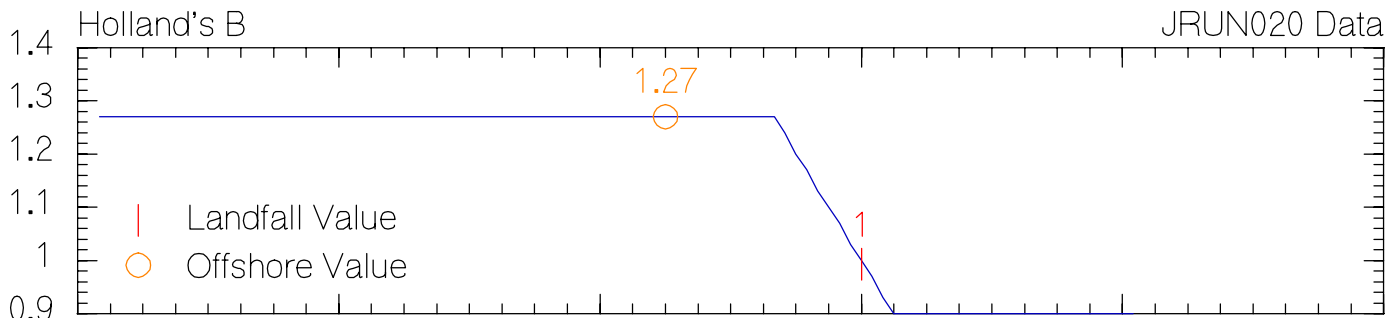
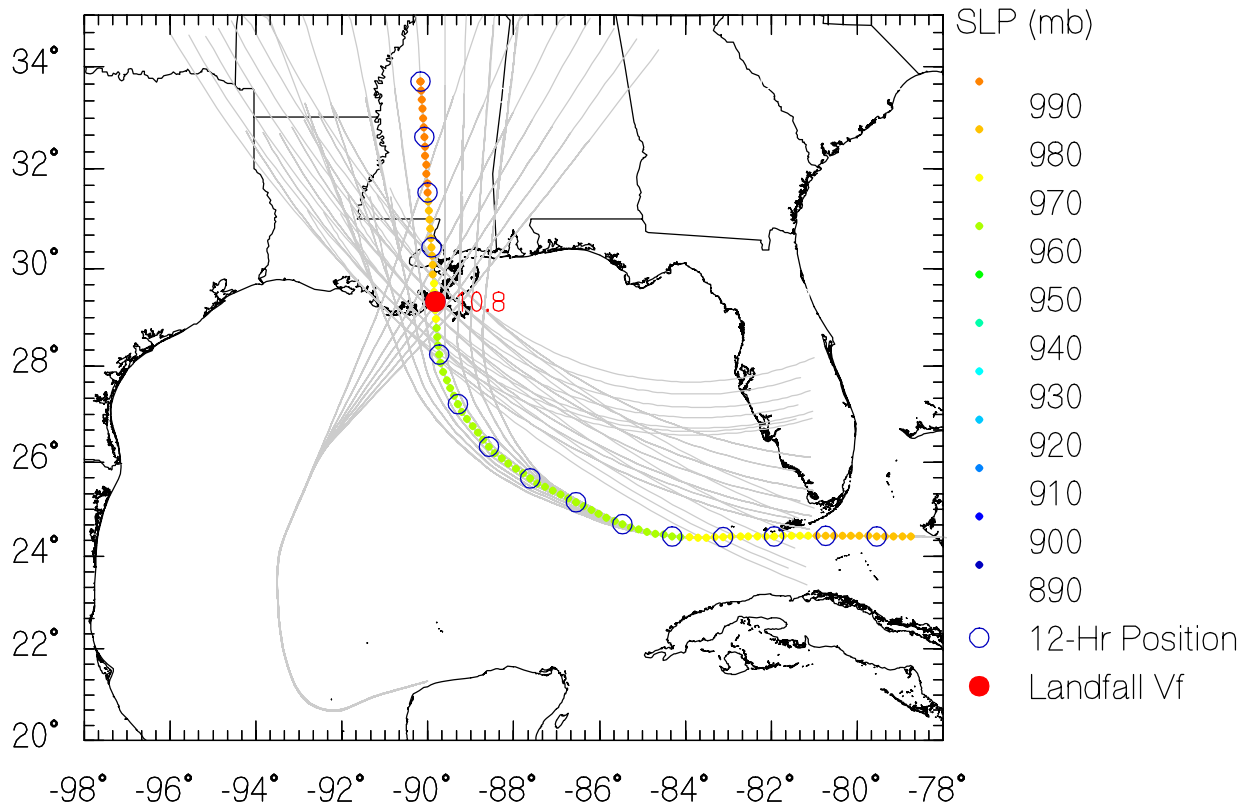

JRUN021 Data

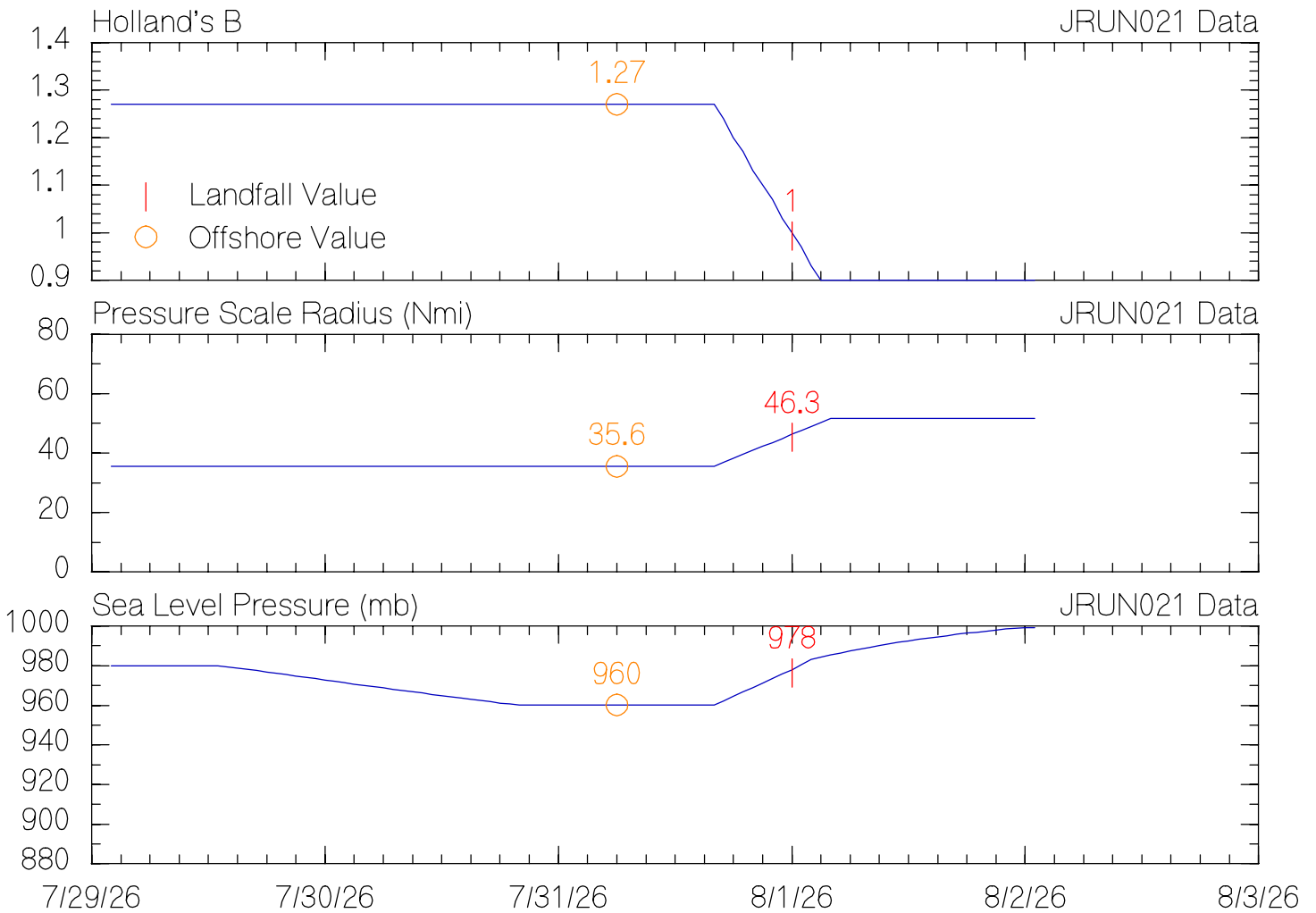
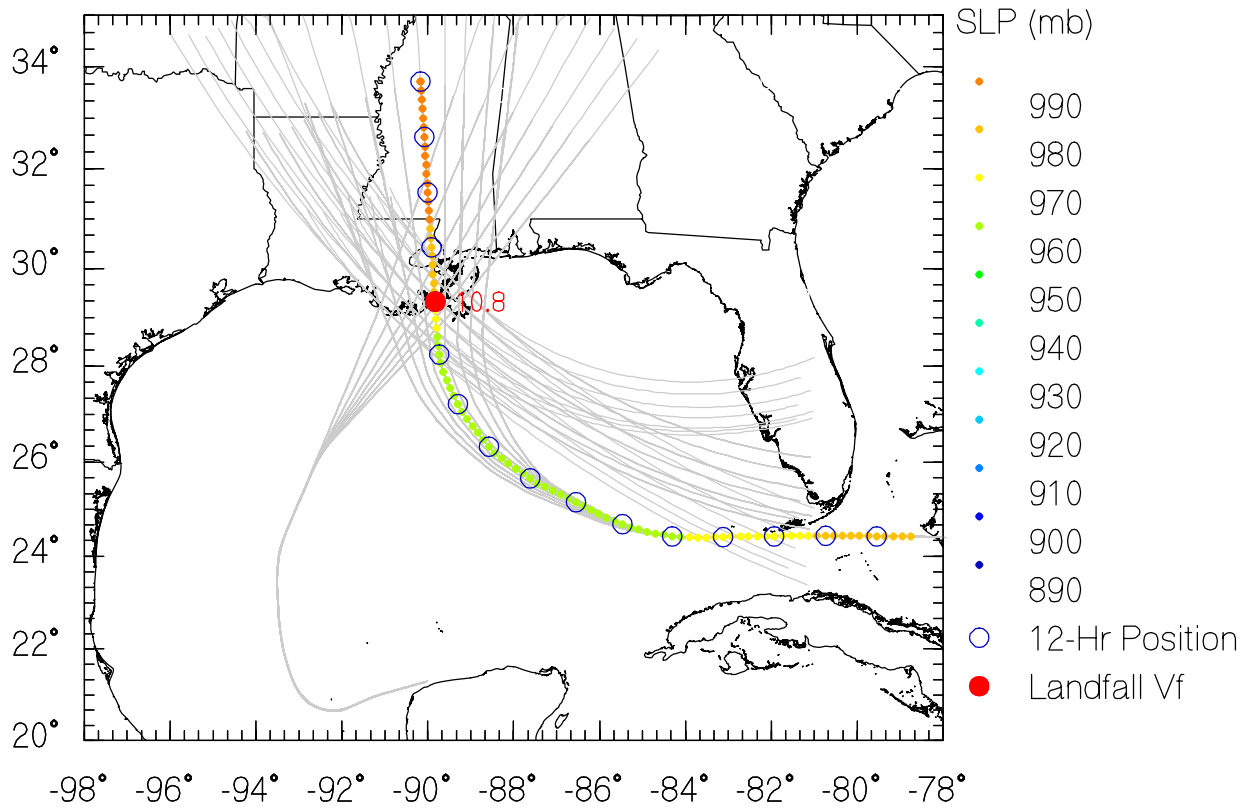

JRUN022 Data

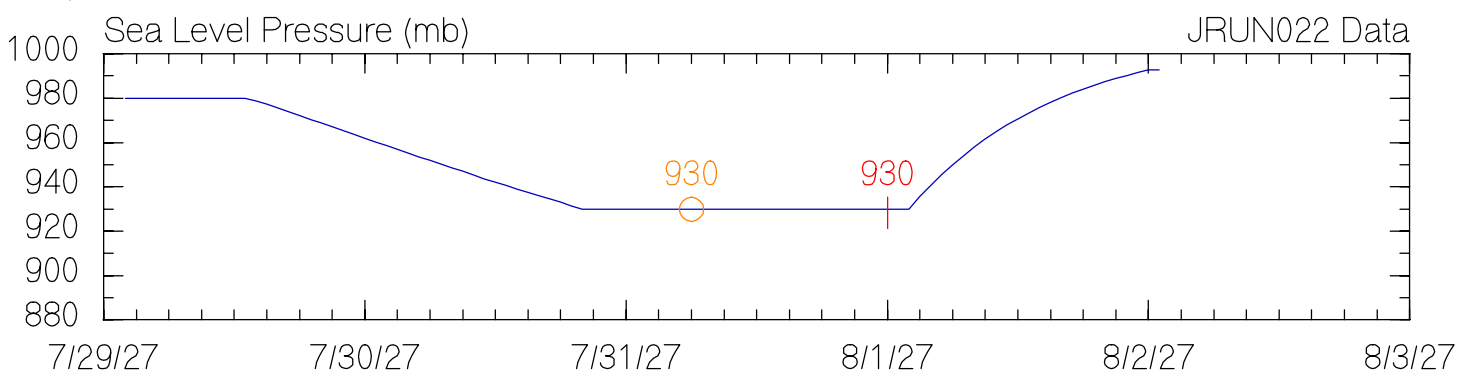
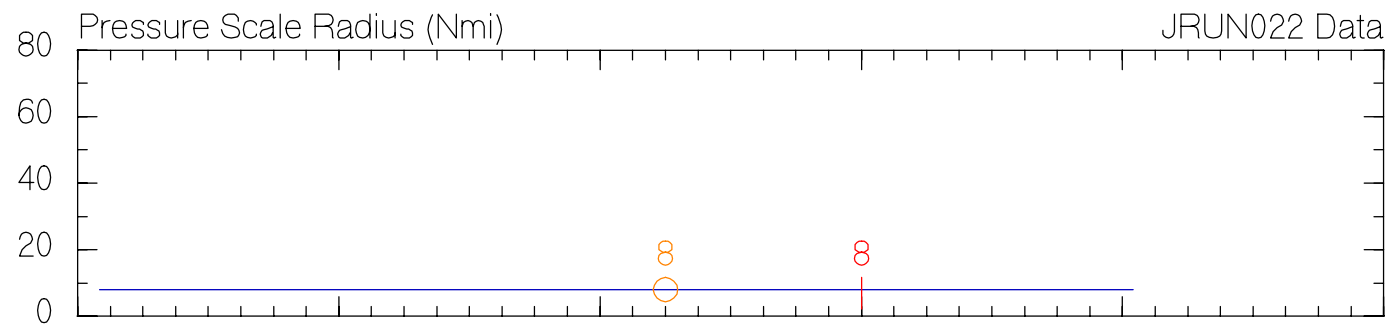
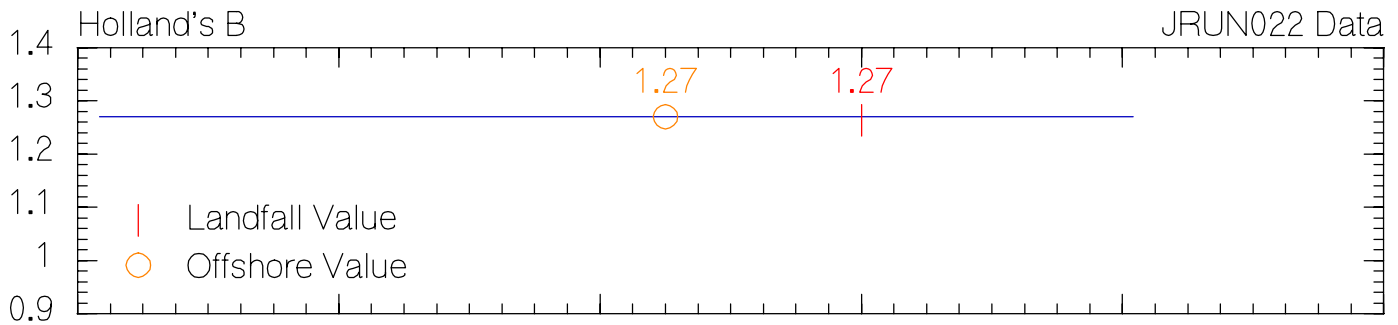
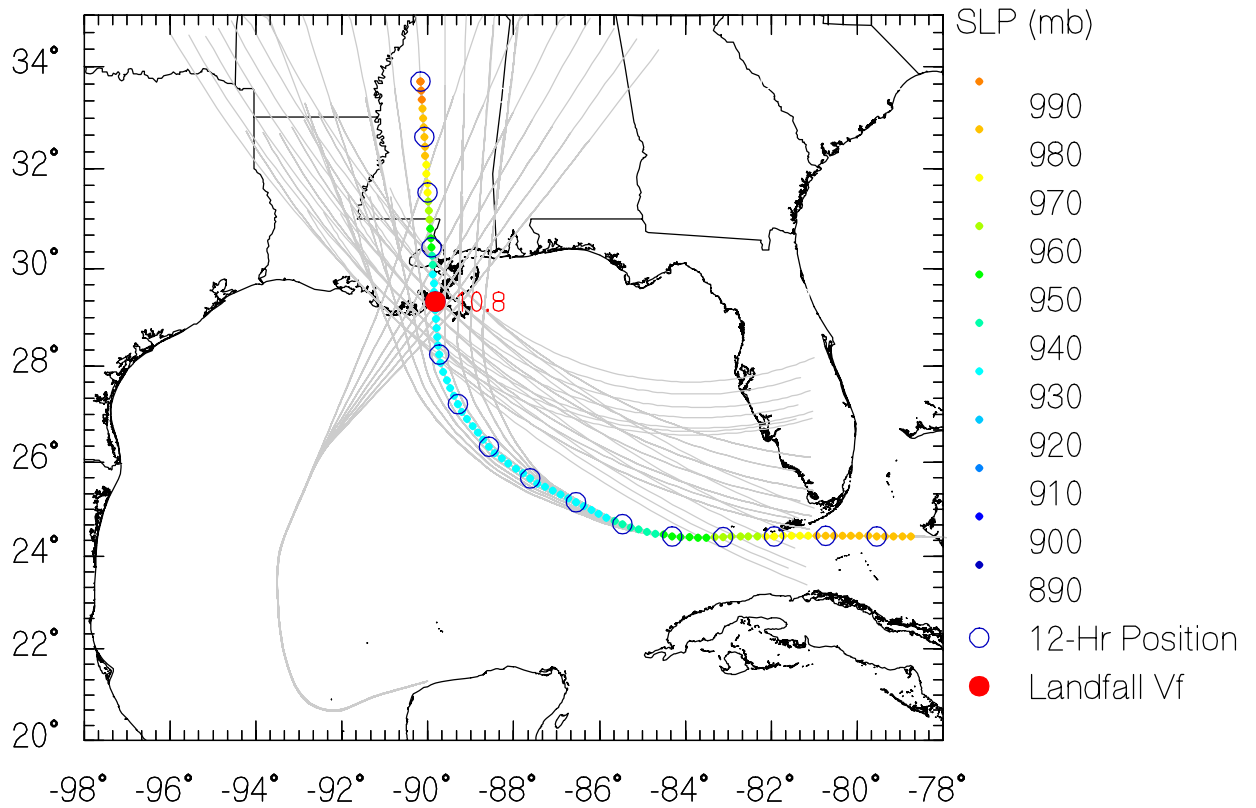

JRUN023 Data

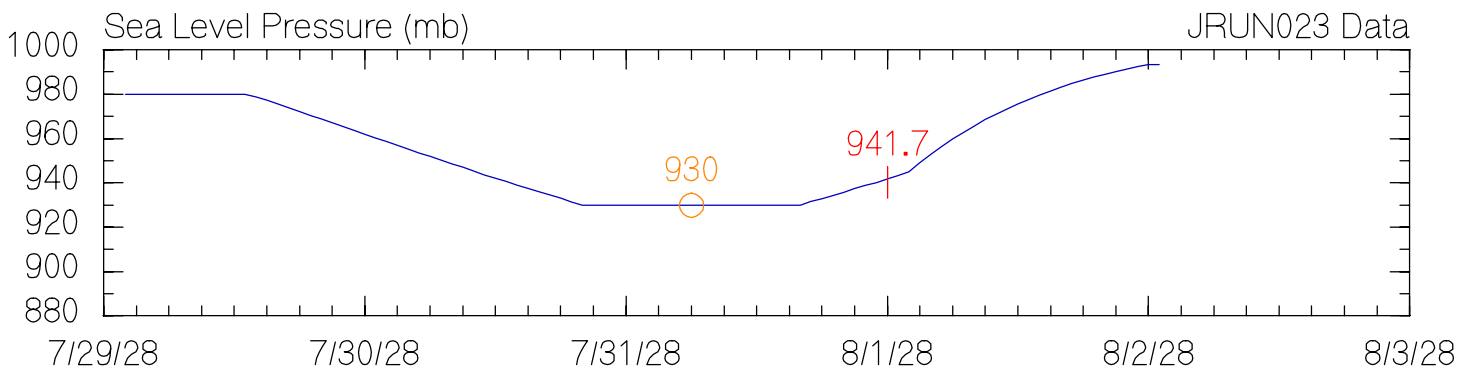
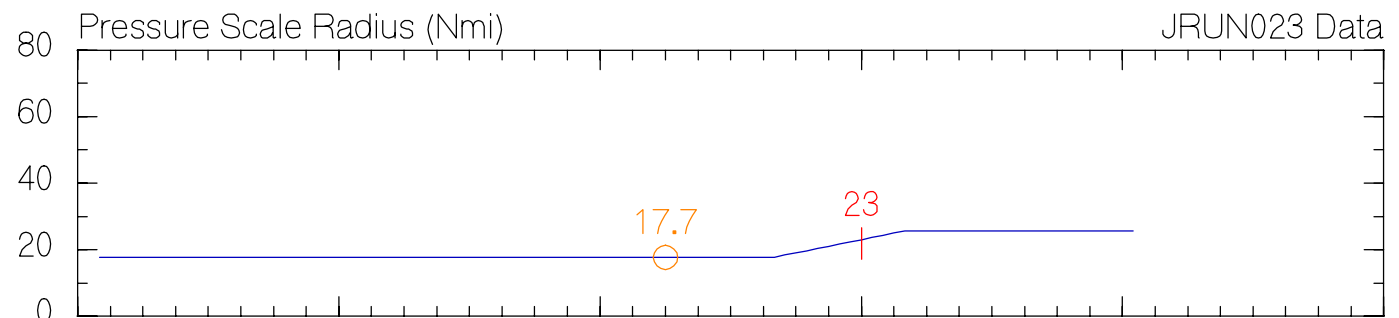
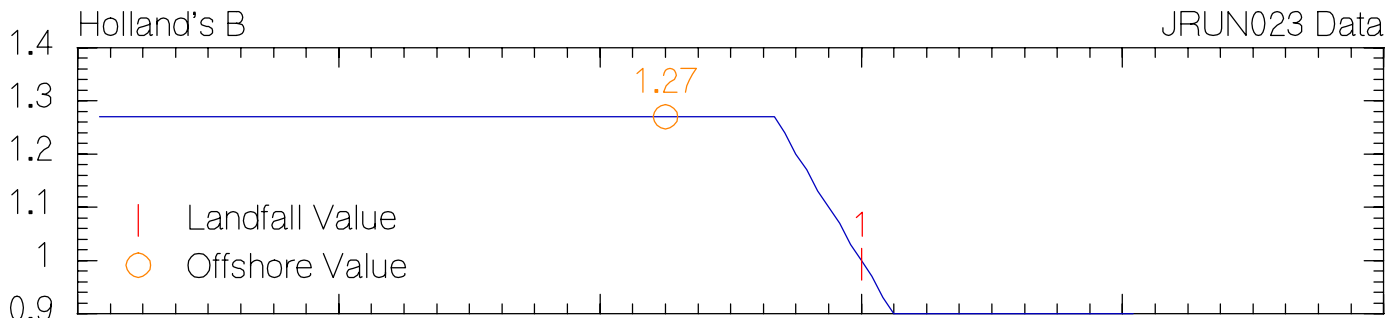
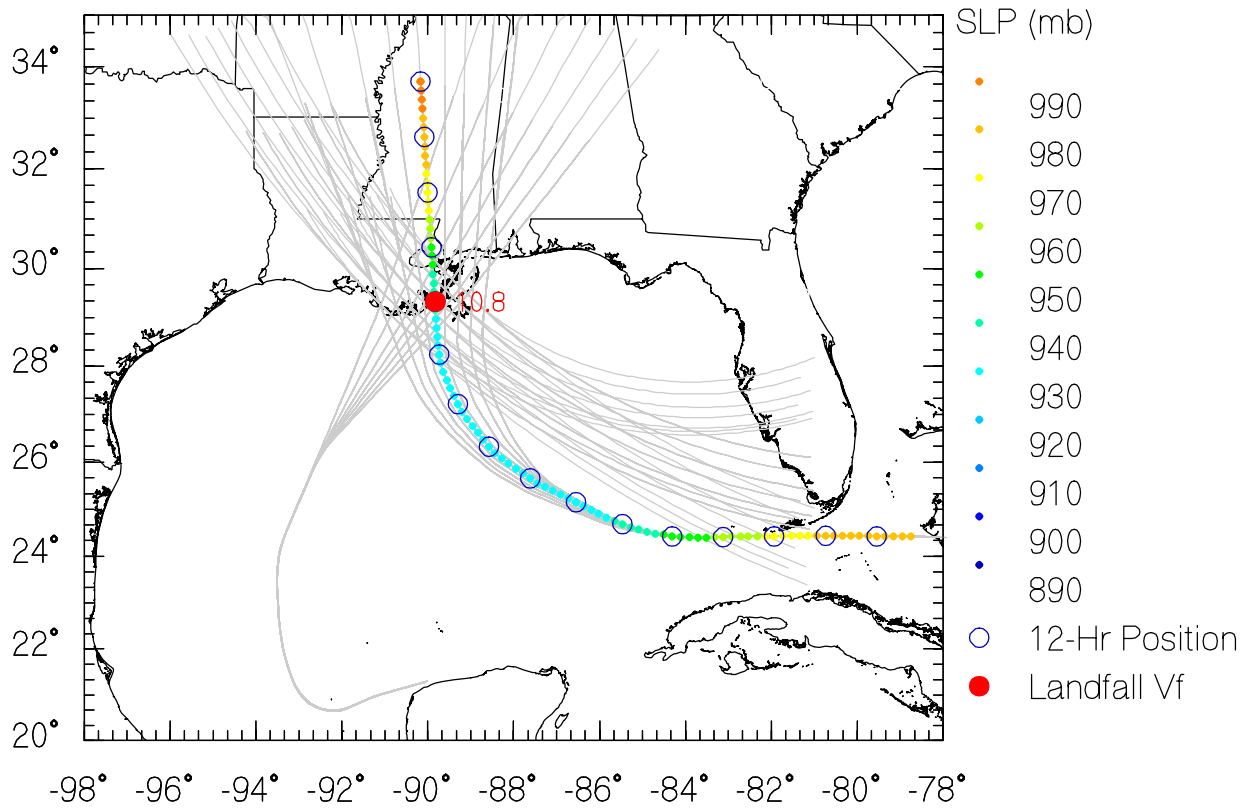

JRUN024 Data

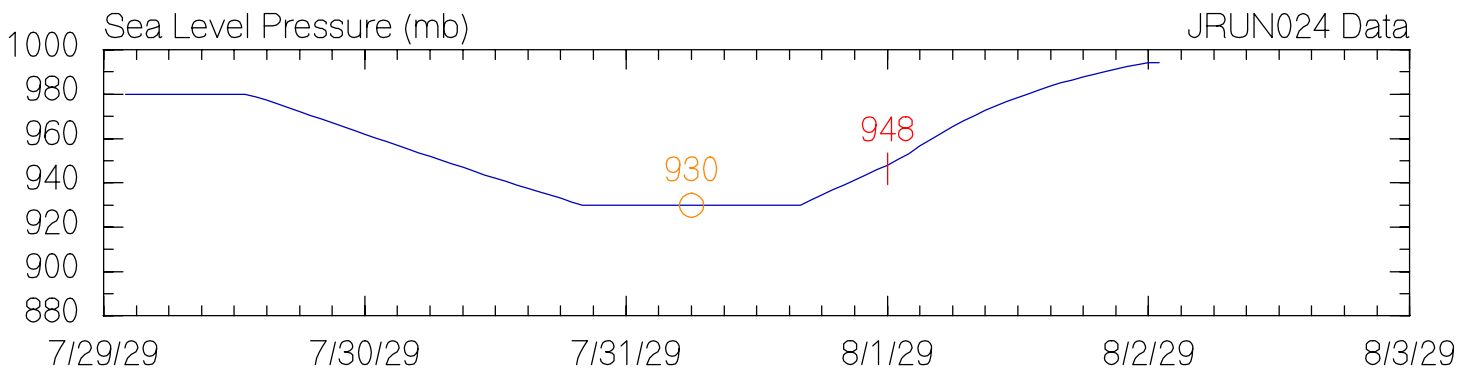
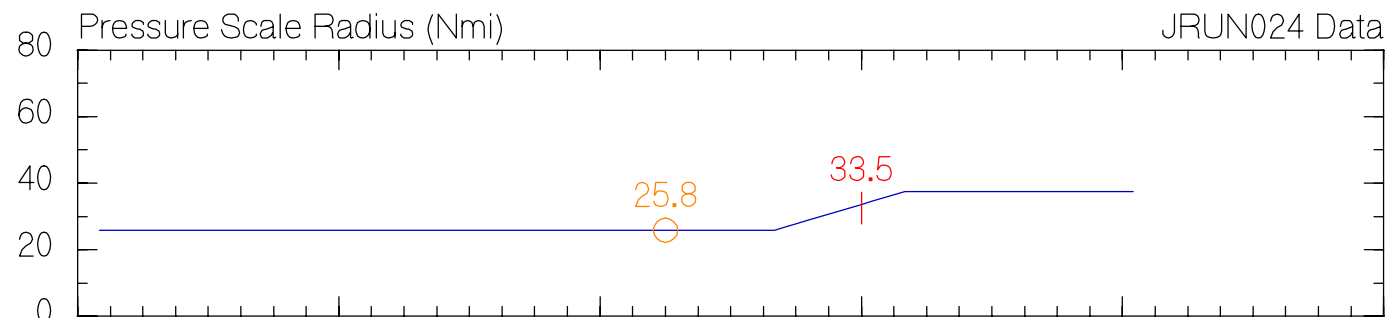
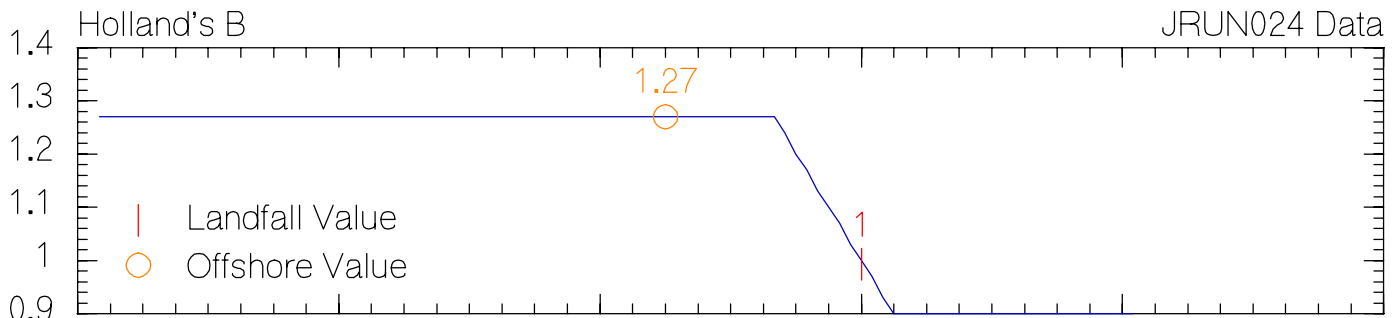
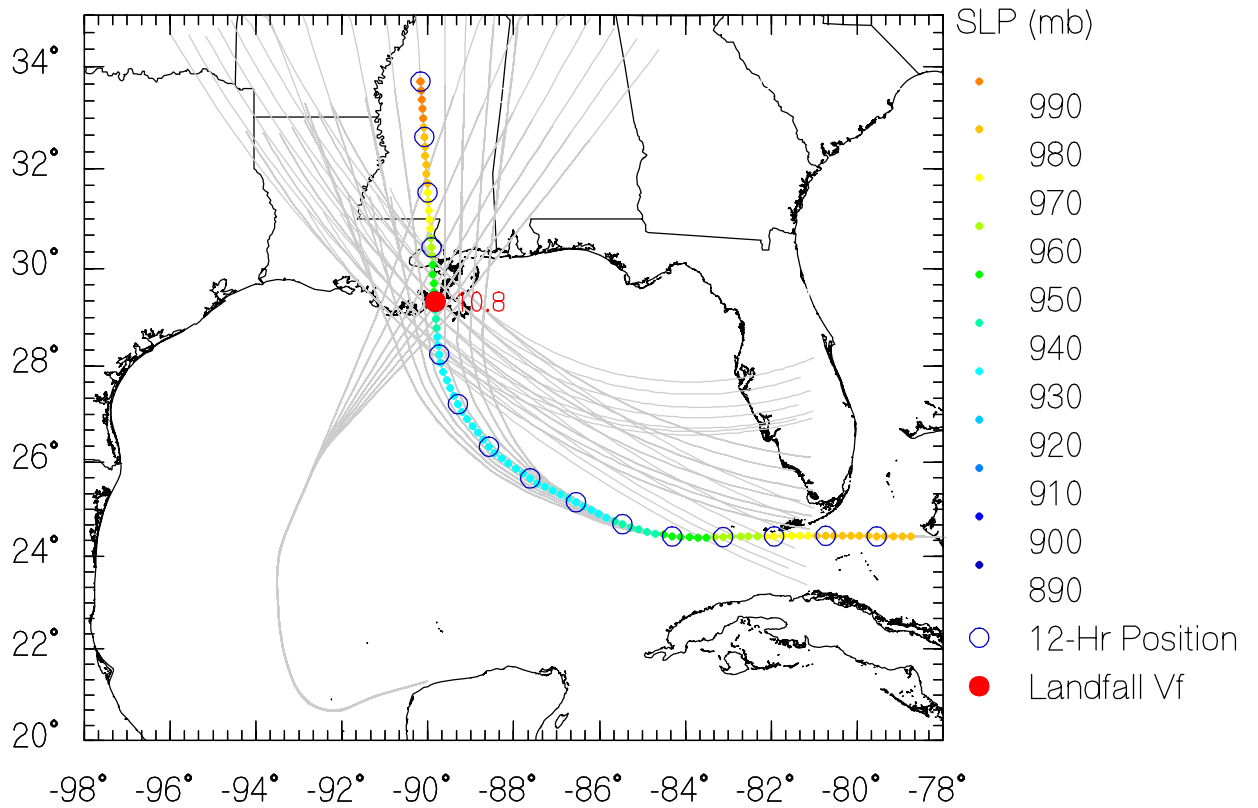

JRUN025 Data

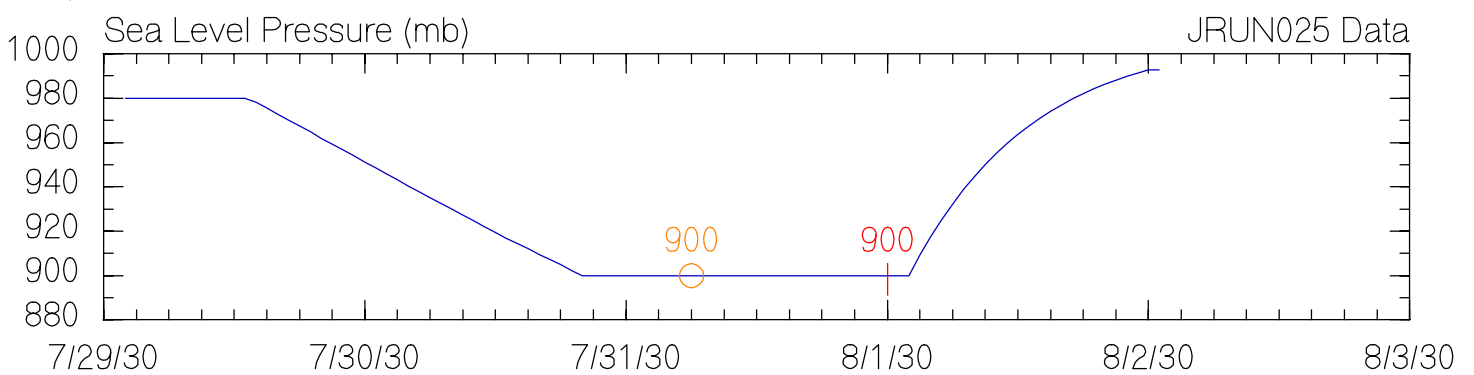
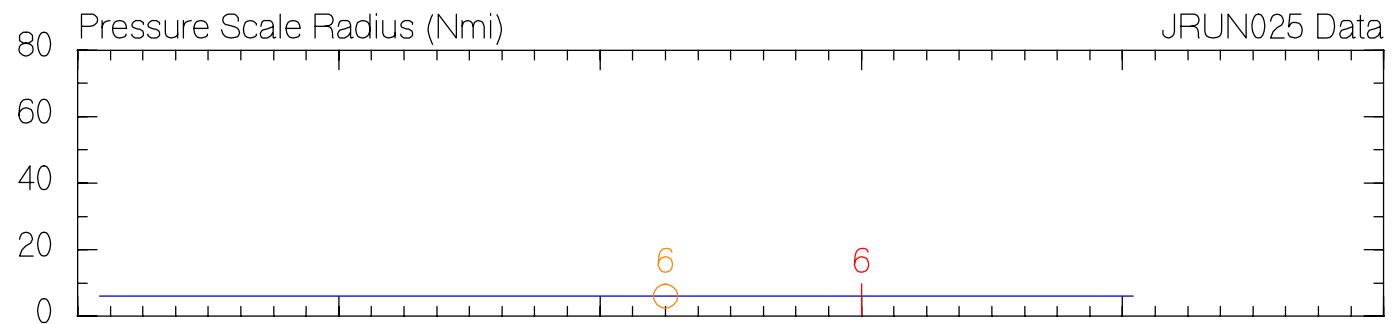
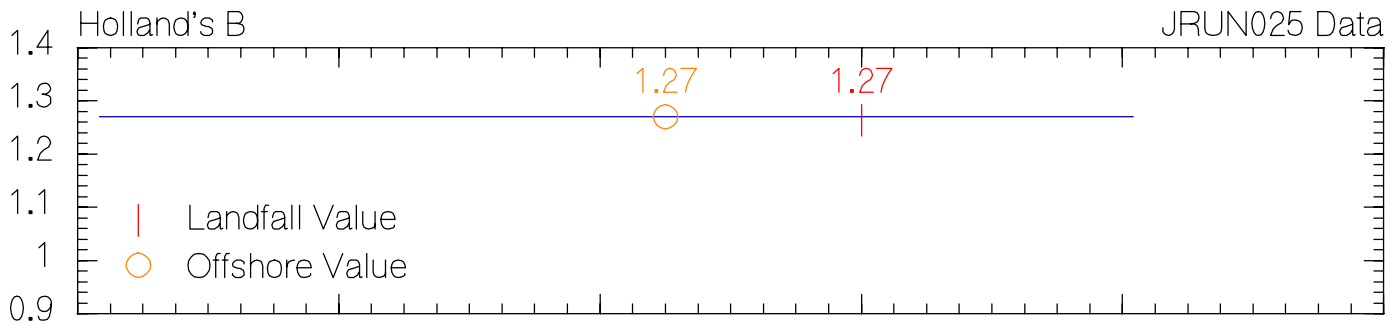
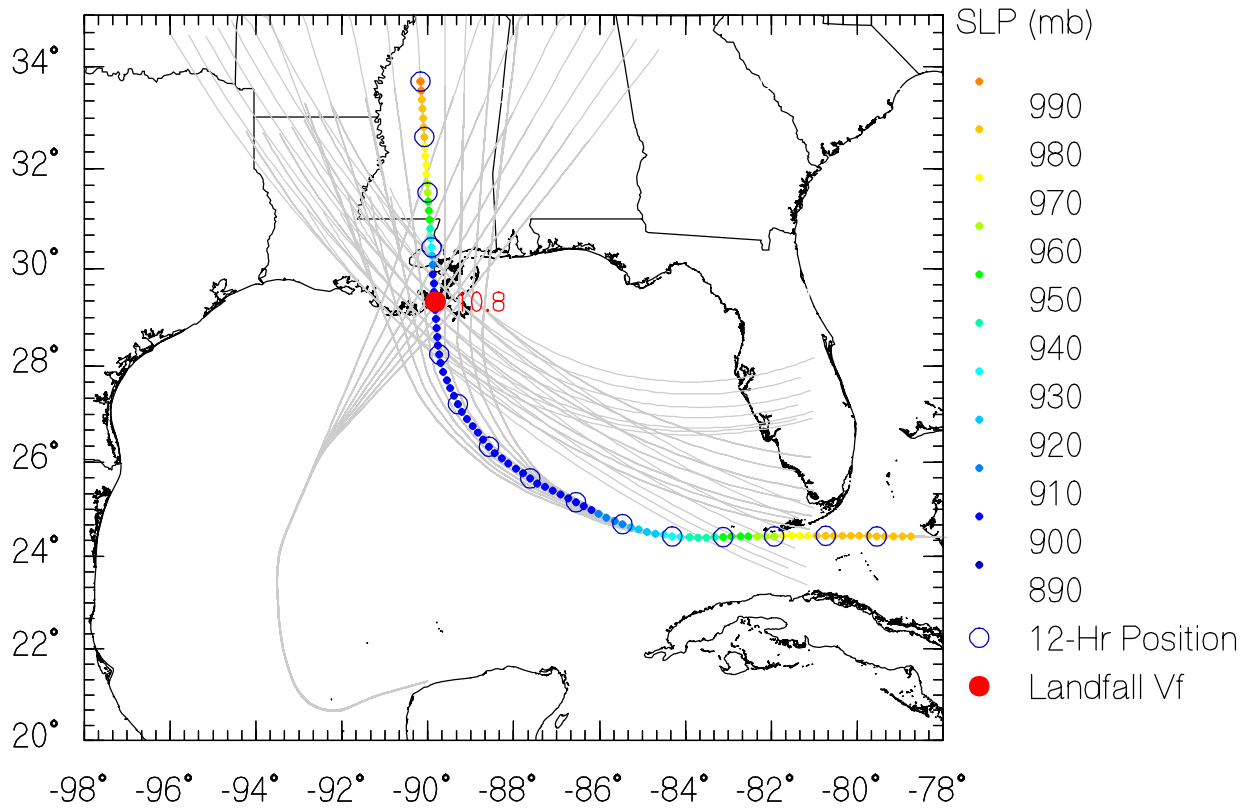

JRUN026 Data

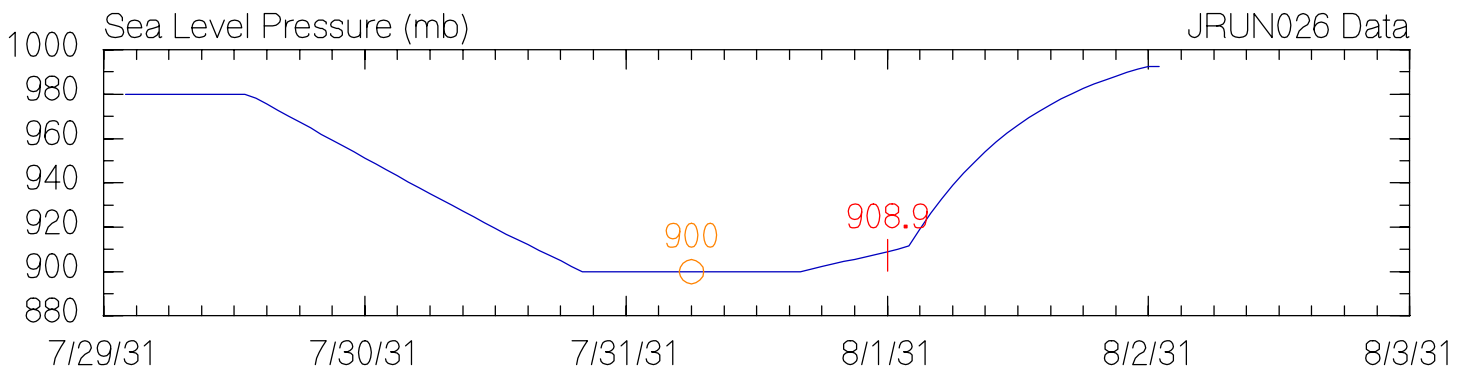
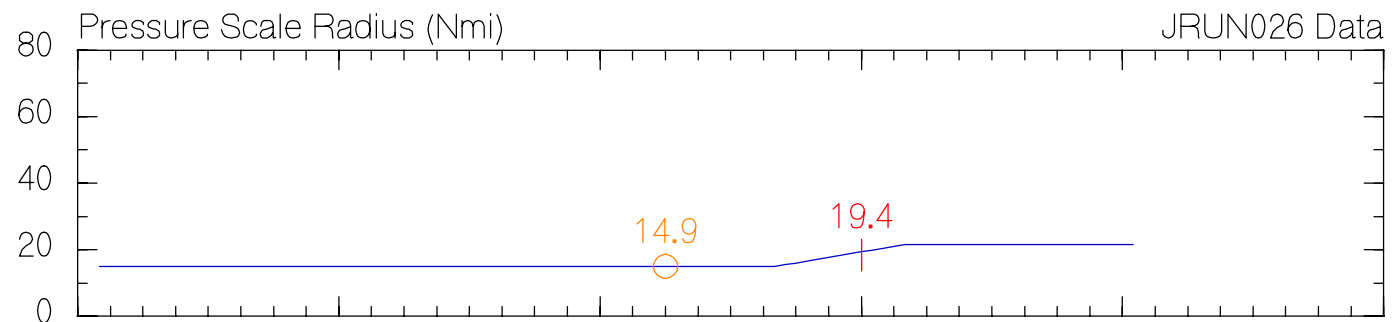
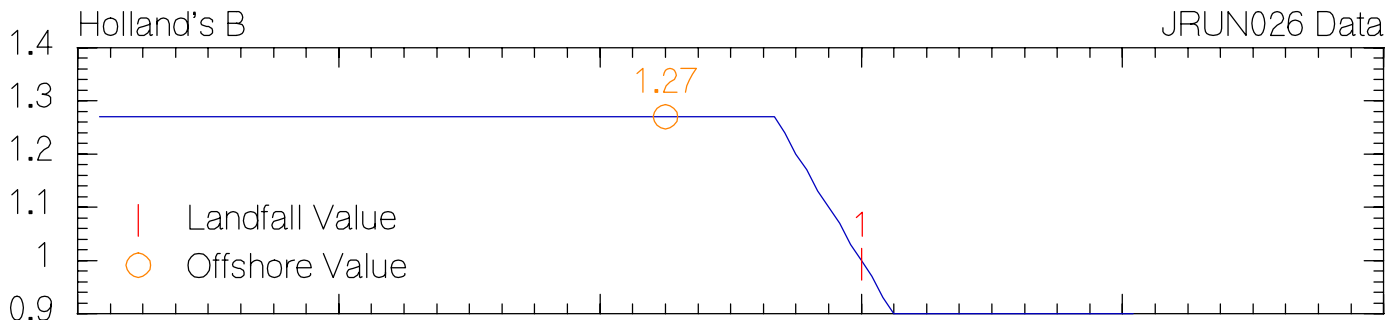
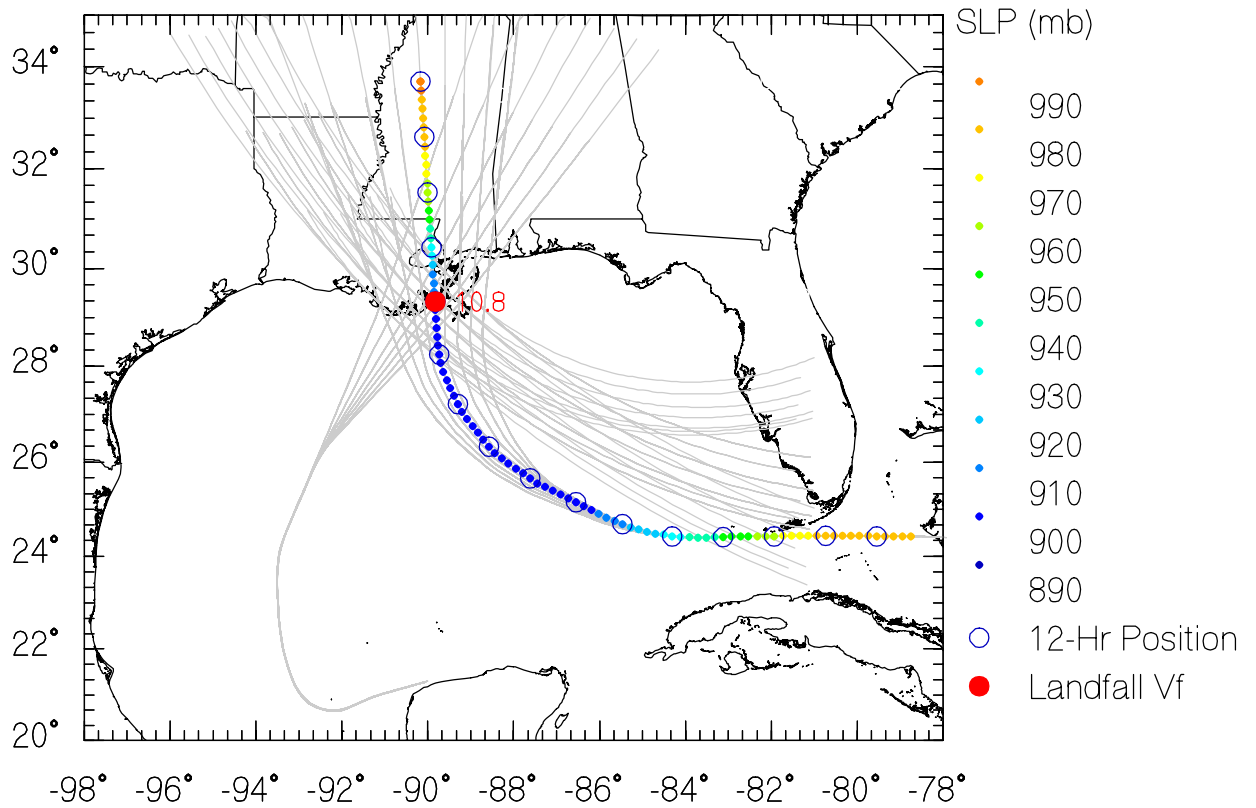

JRUN027 Data

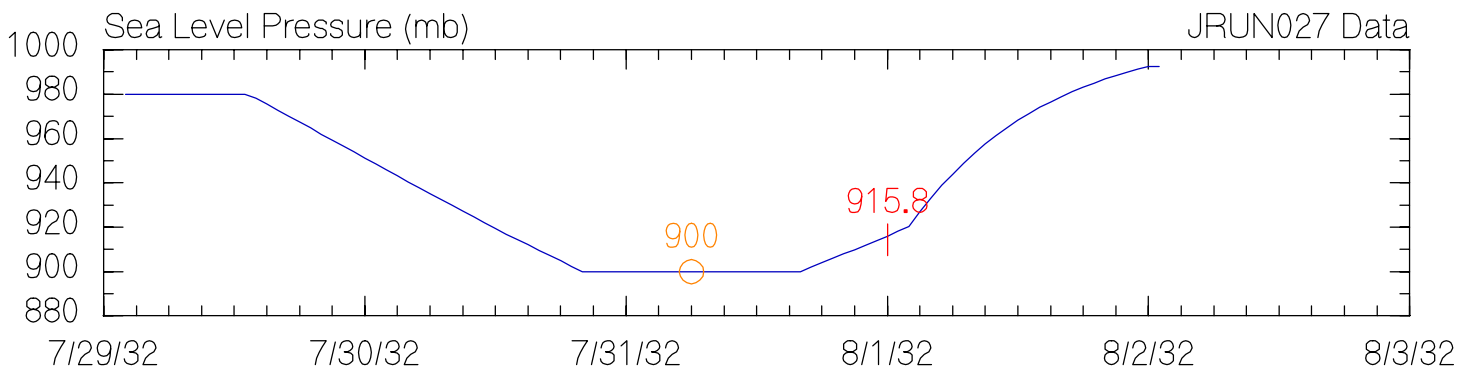
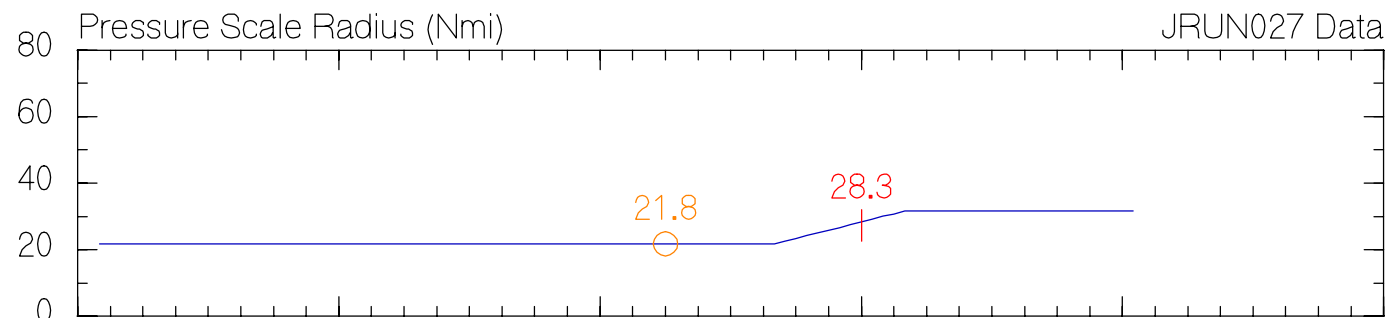
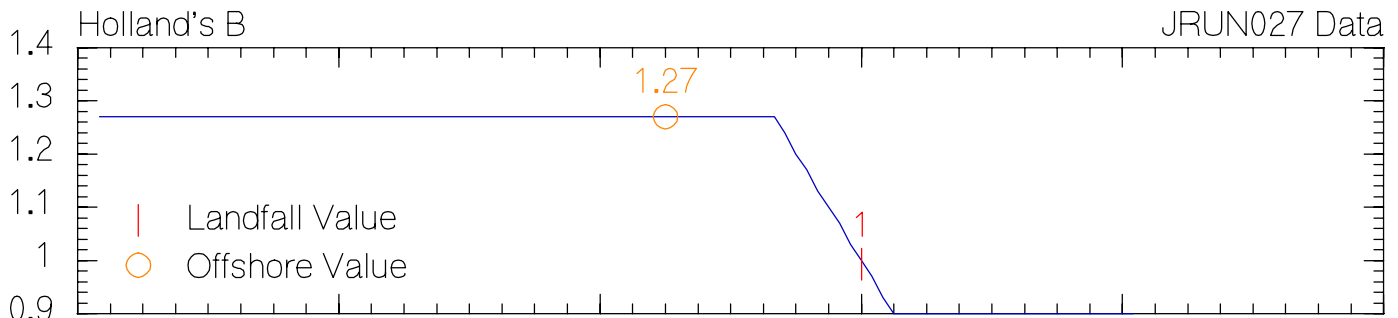
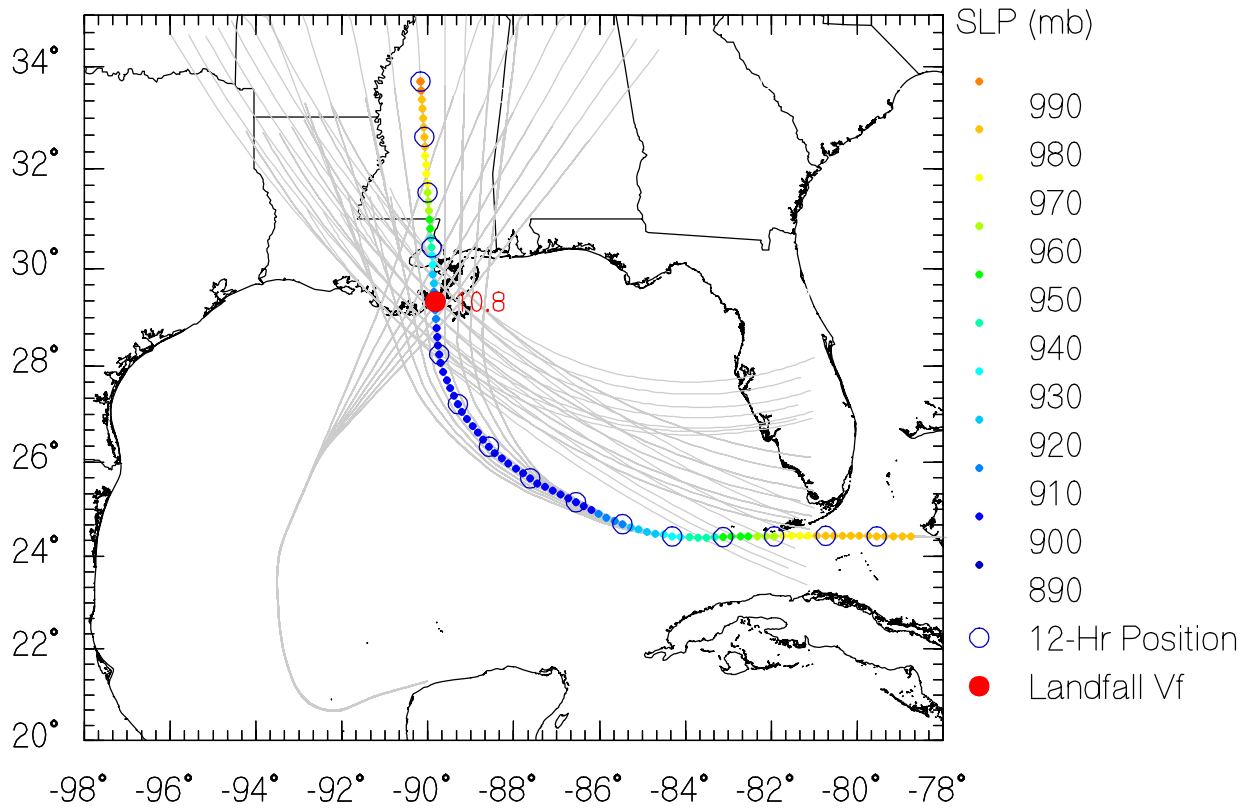

JRUN028 Data

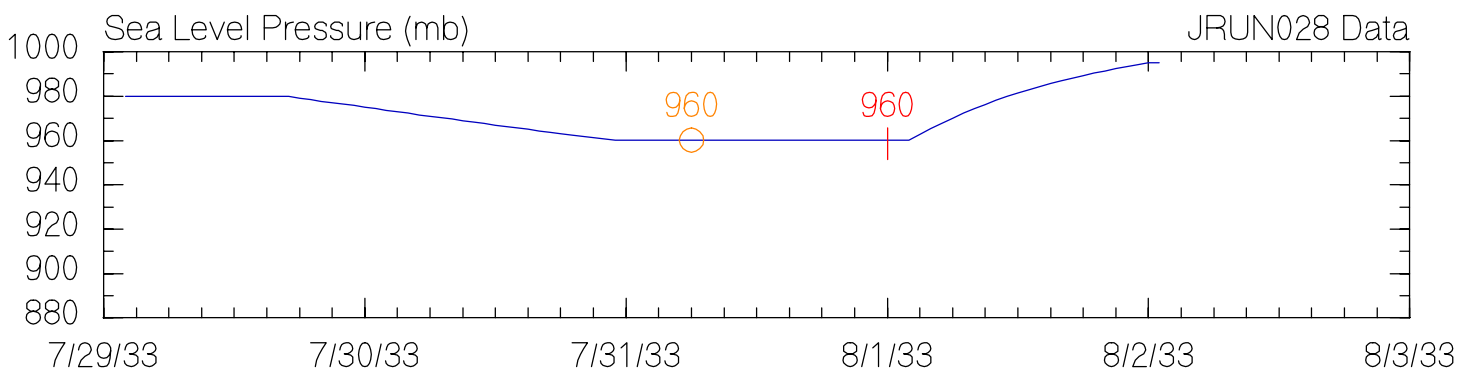
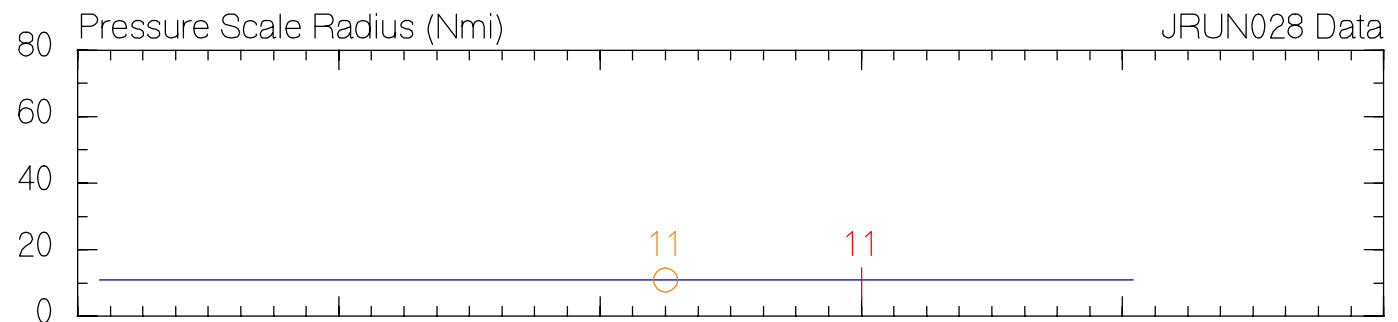
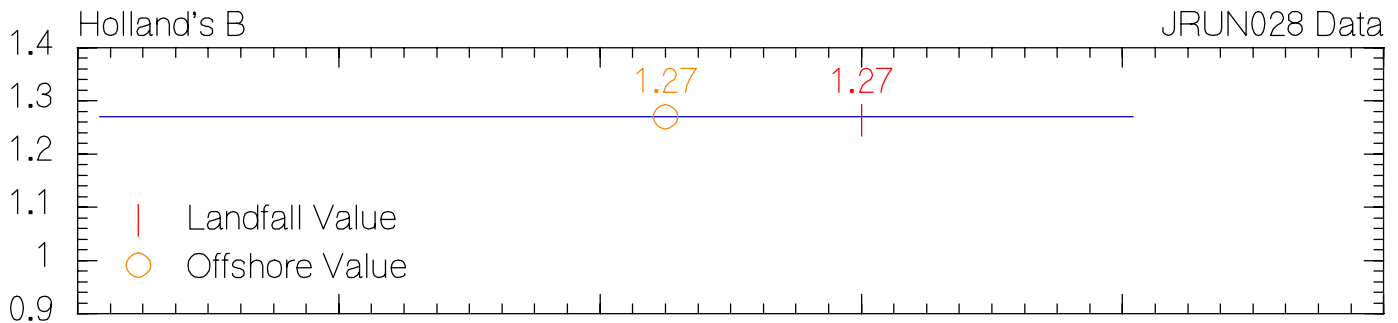
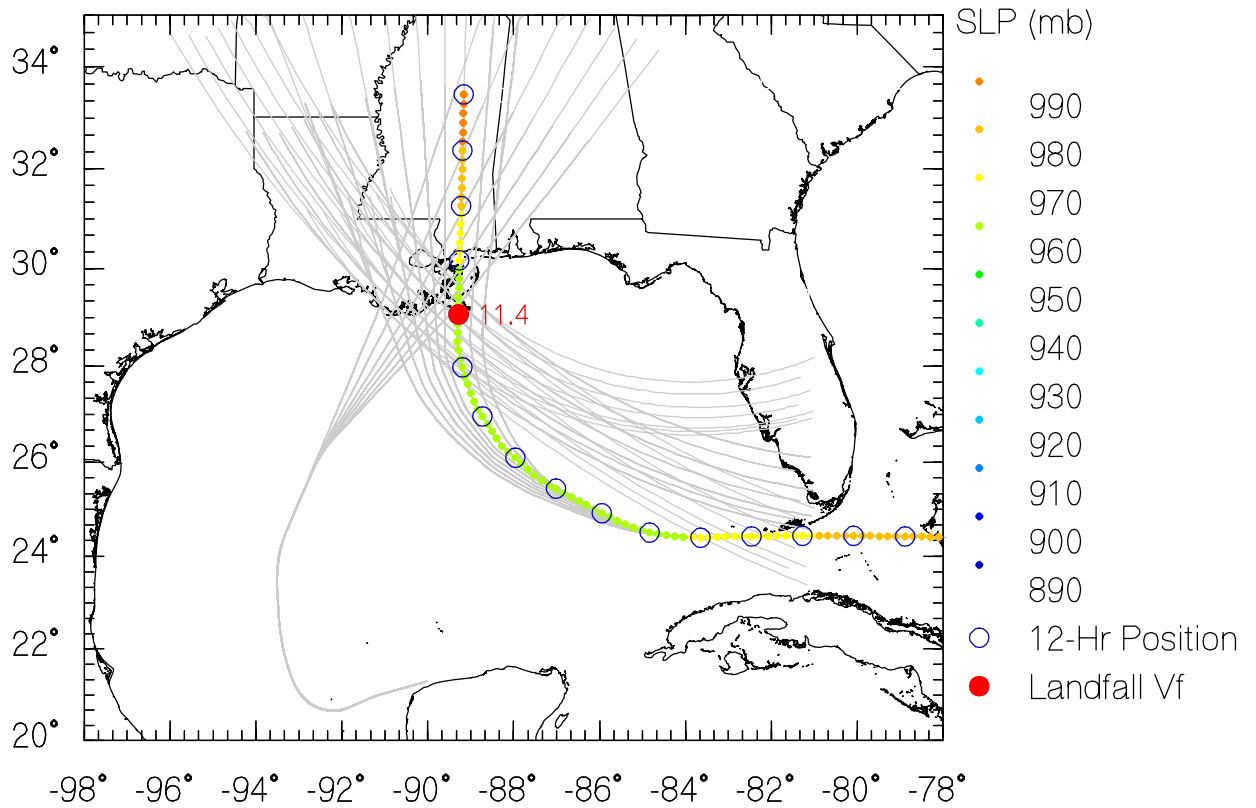

JRUN029 Data

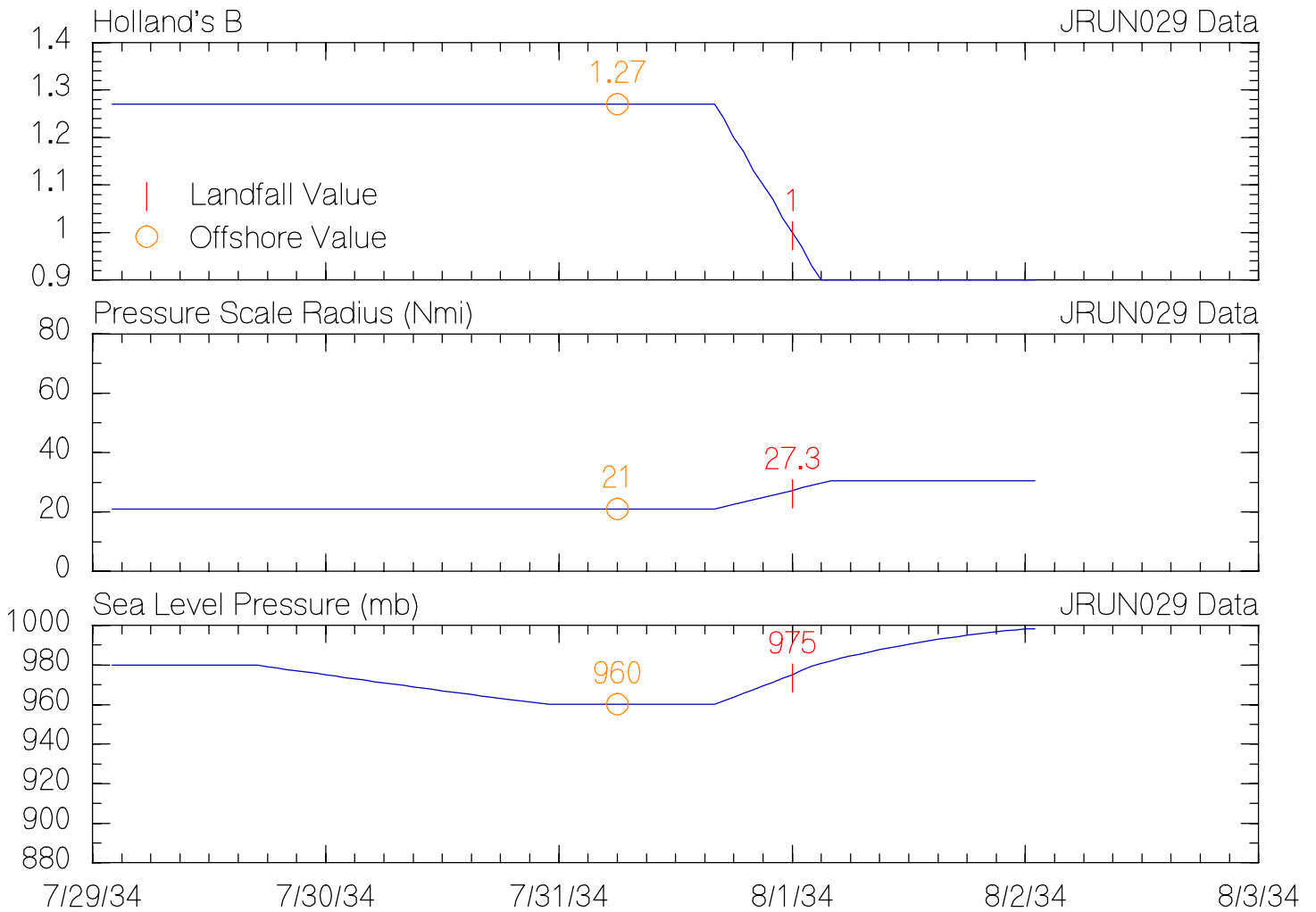
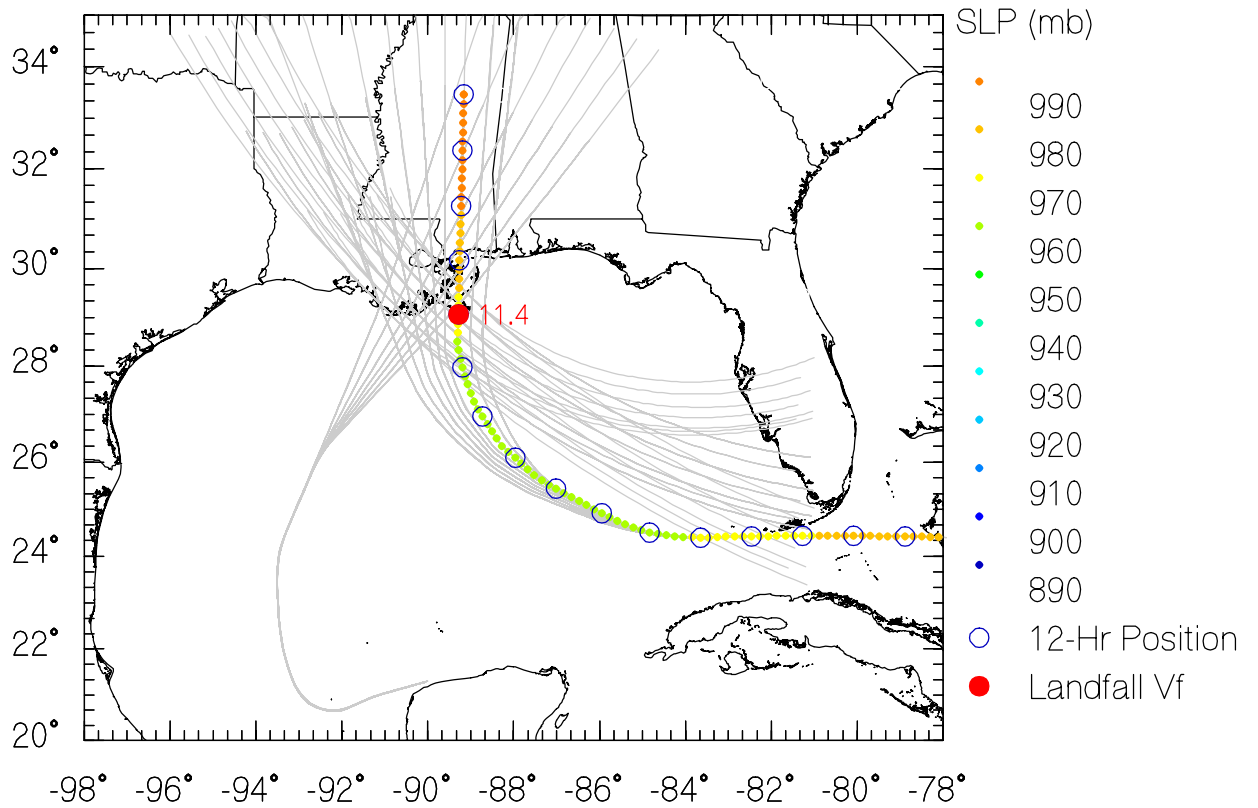

JRUN030 Data

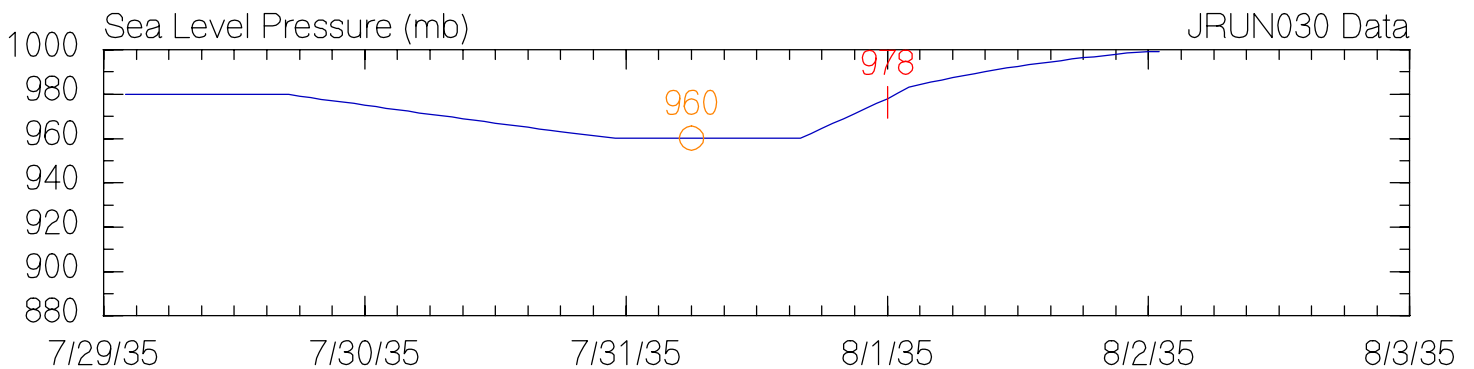
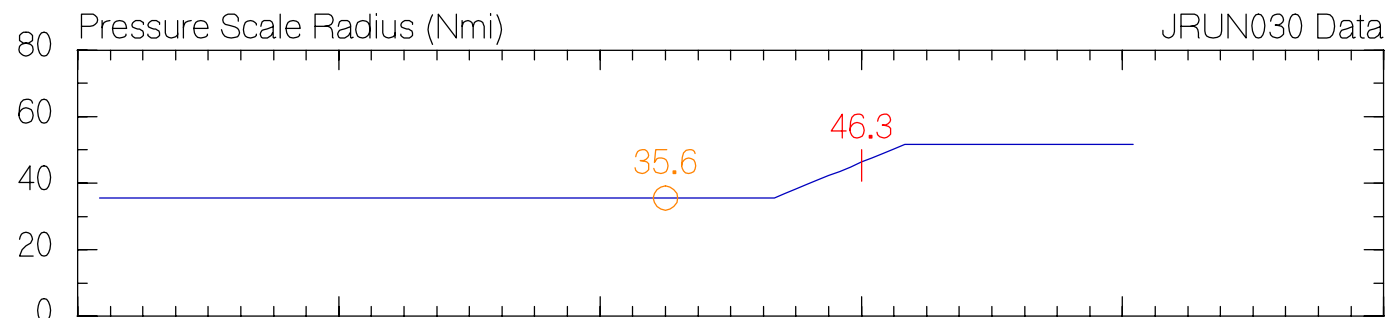
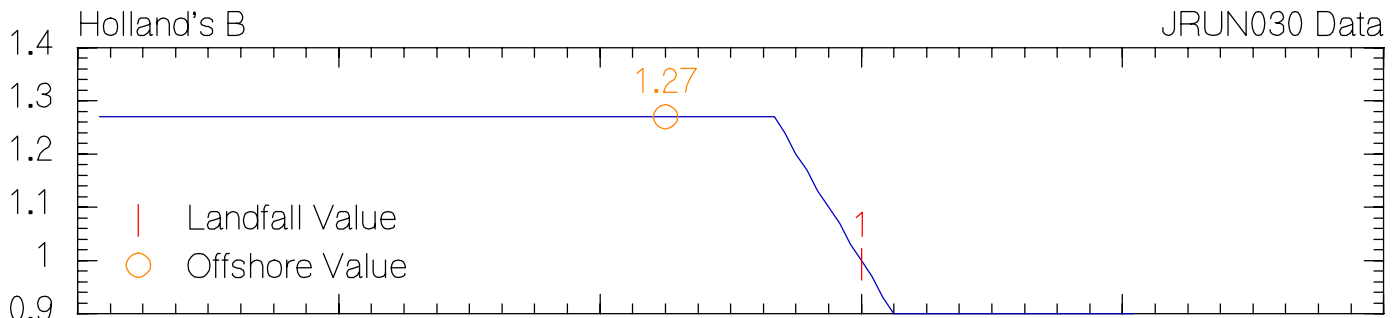
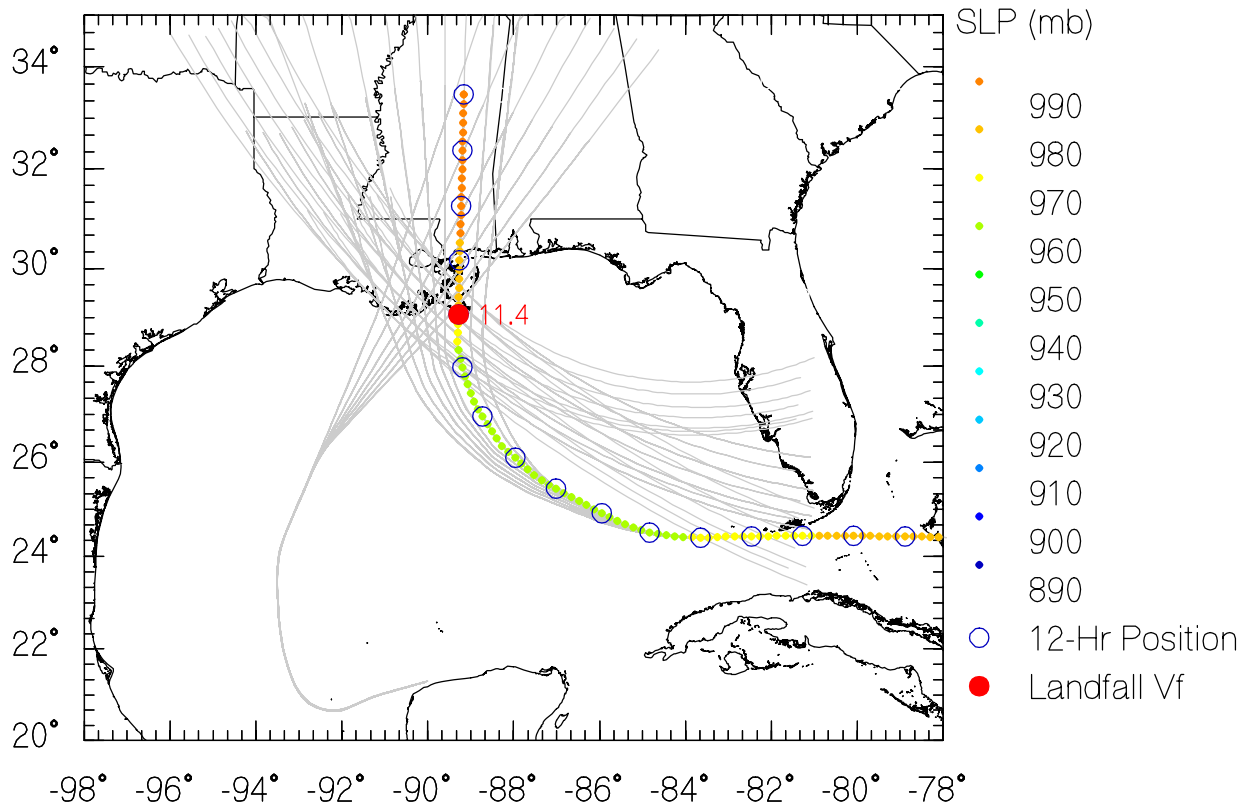

JRUN031 Data

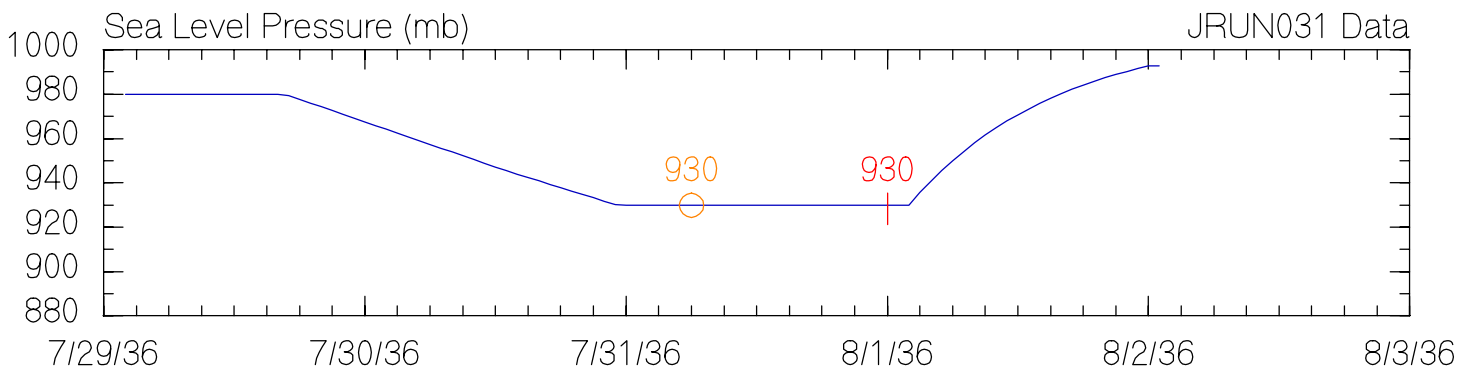
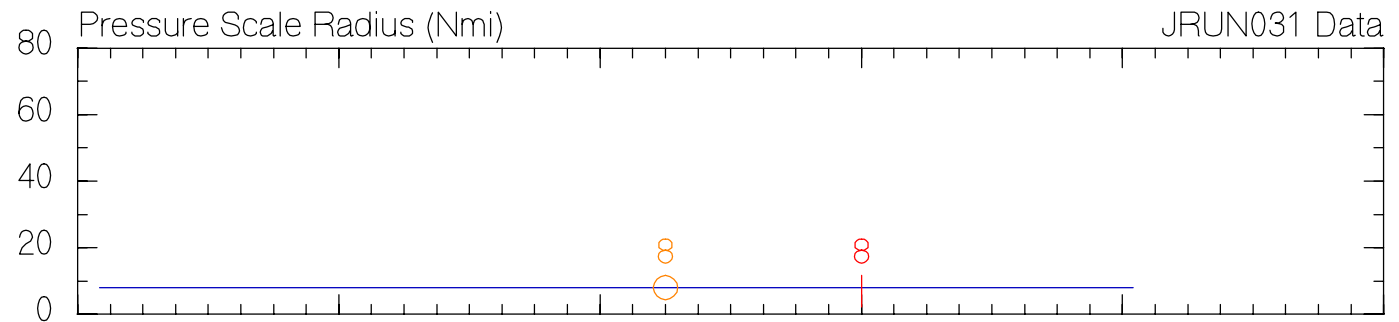
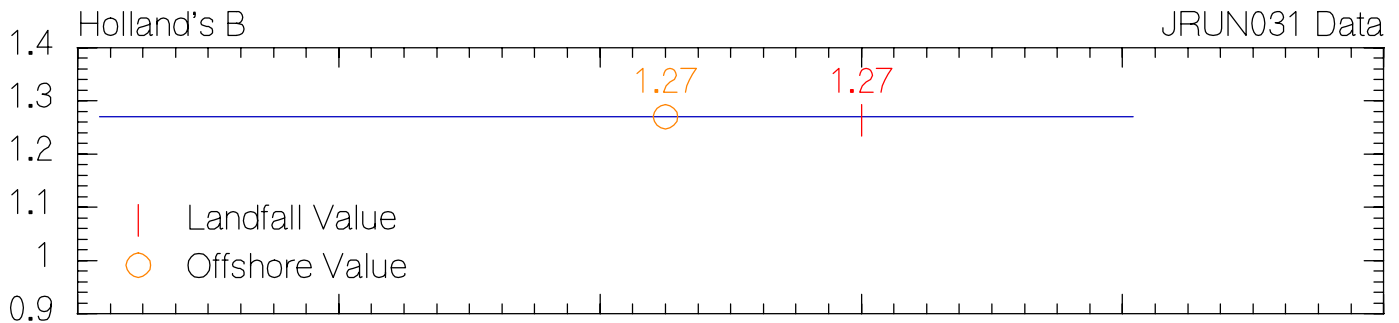
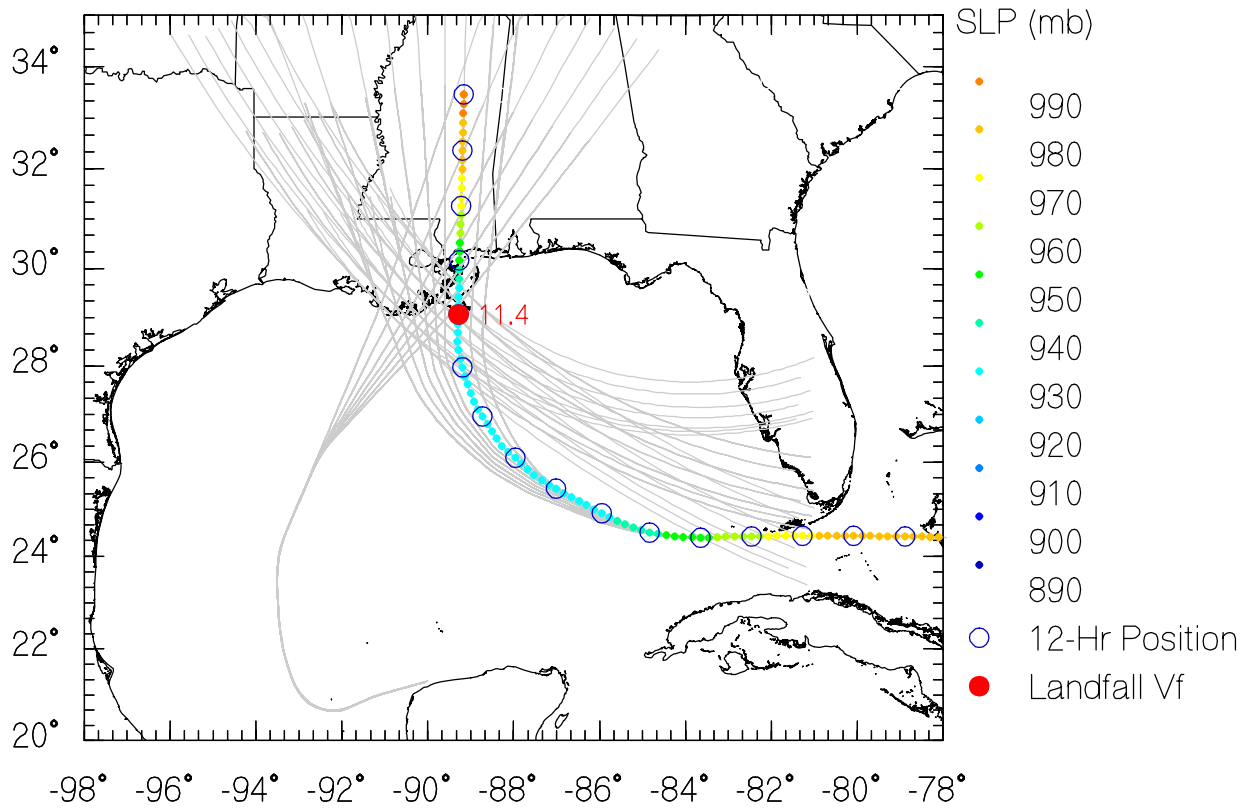

JRUN032 Data

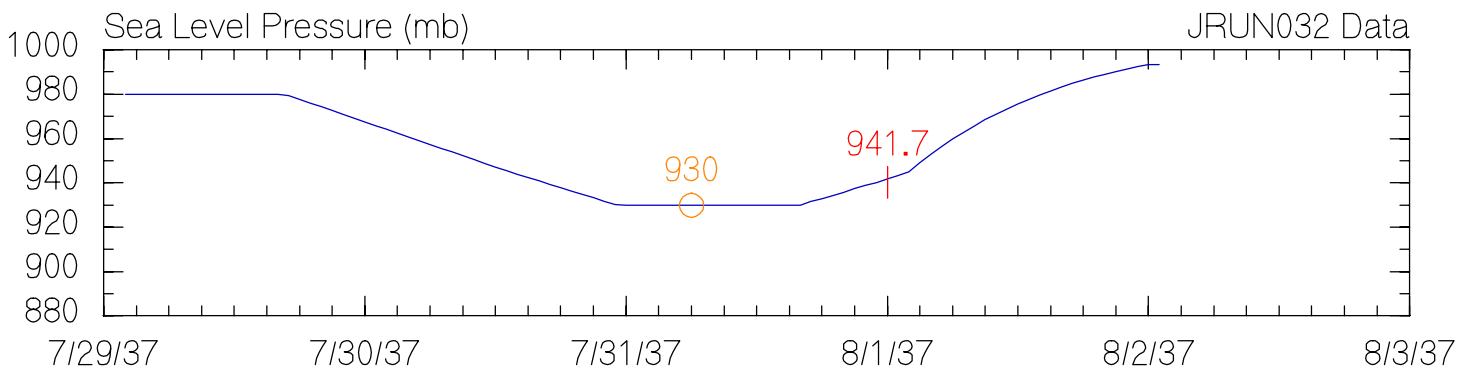
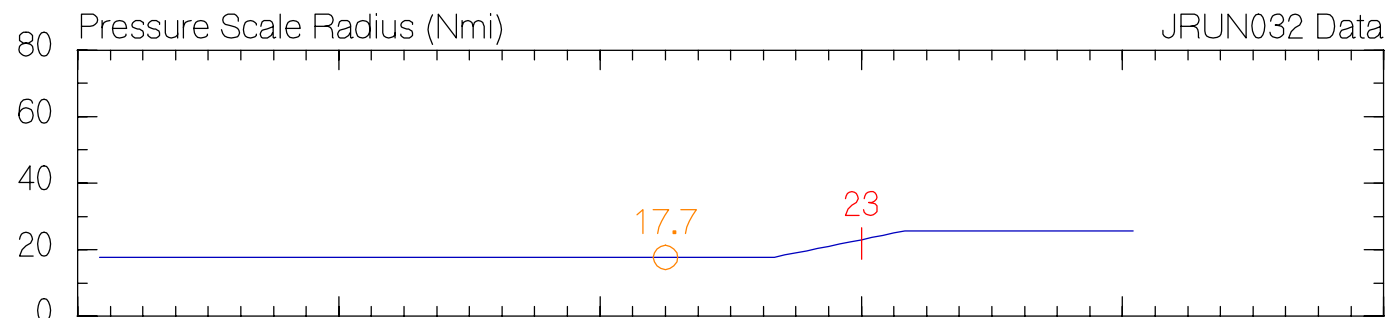
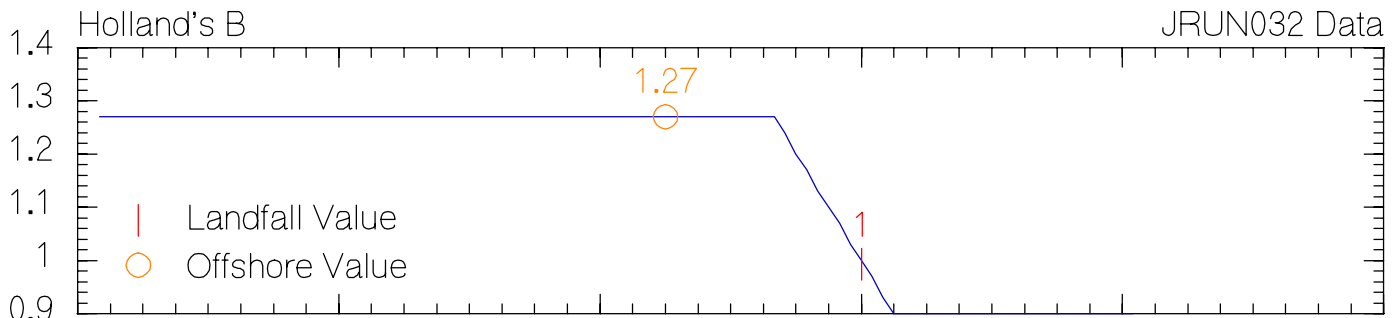
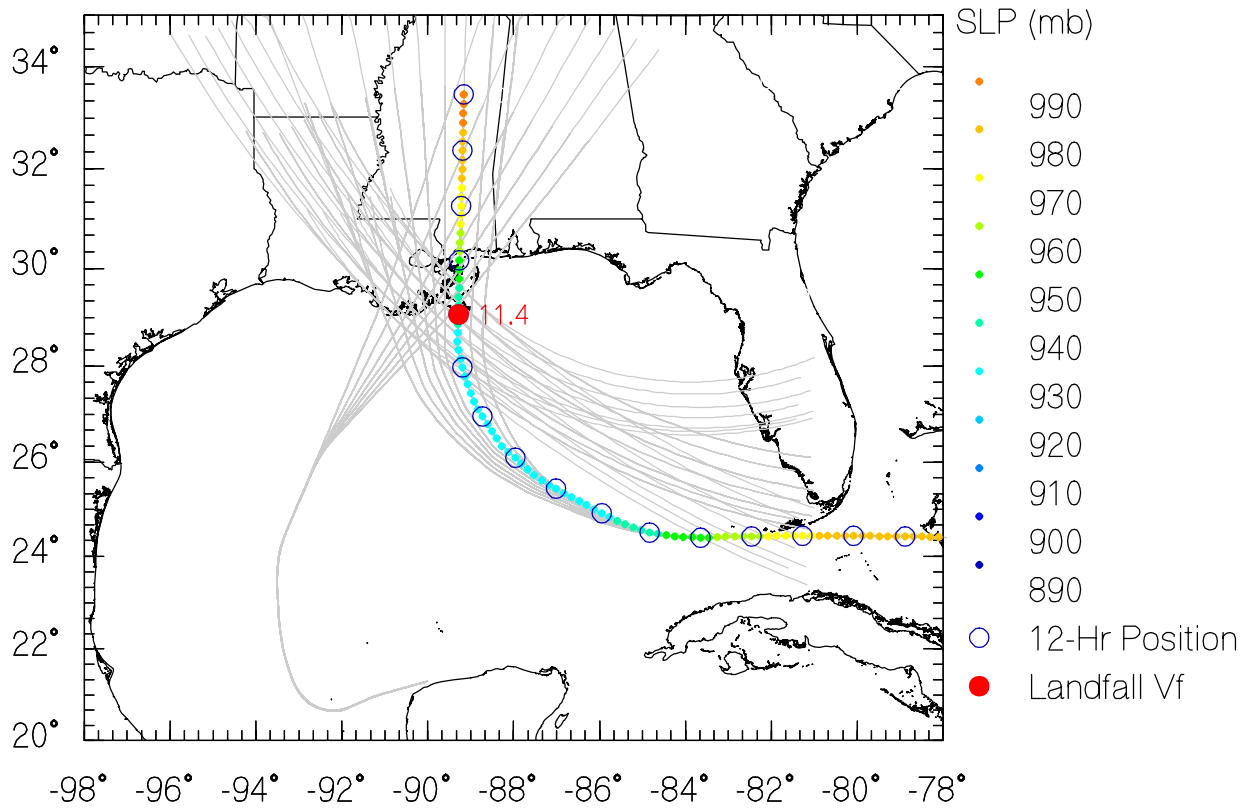

JRUN033 Data

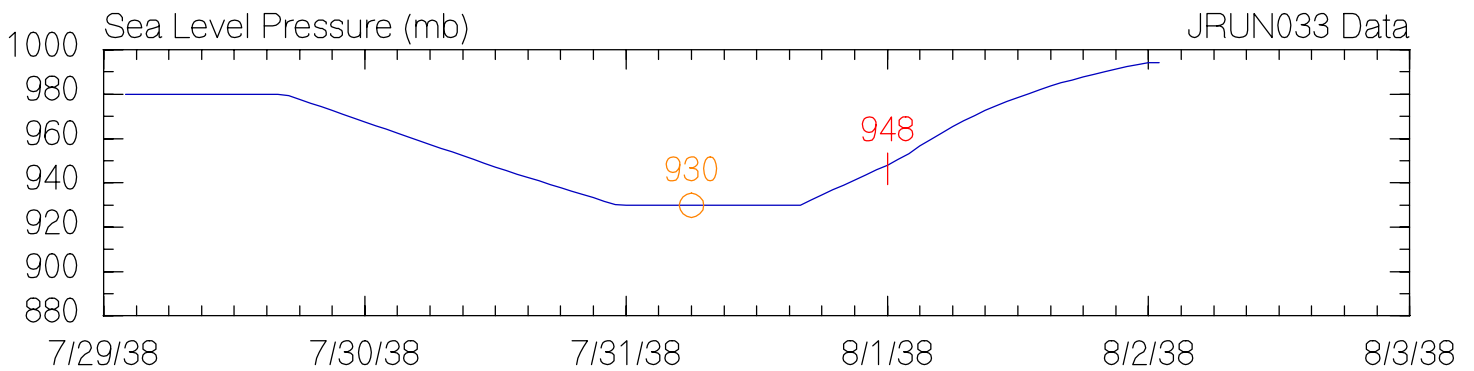
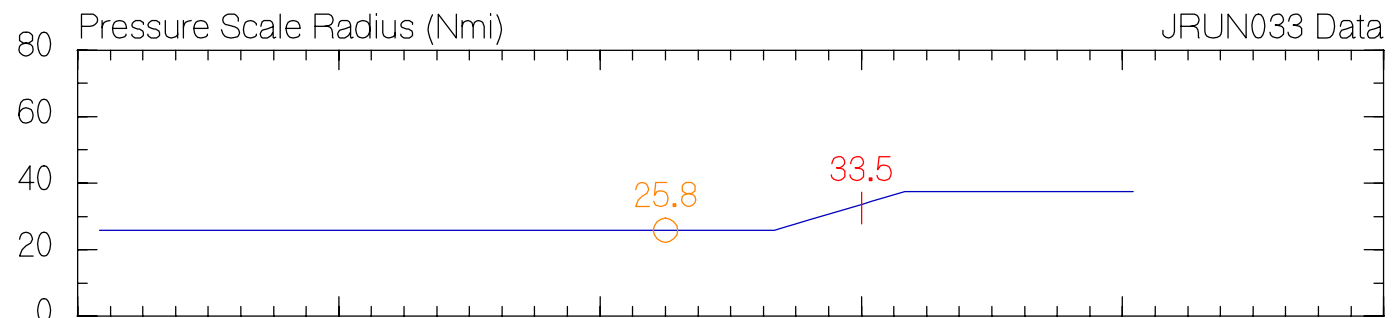
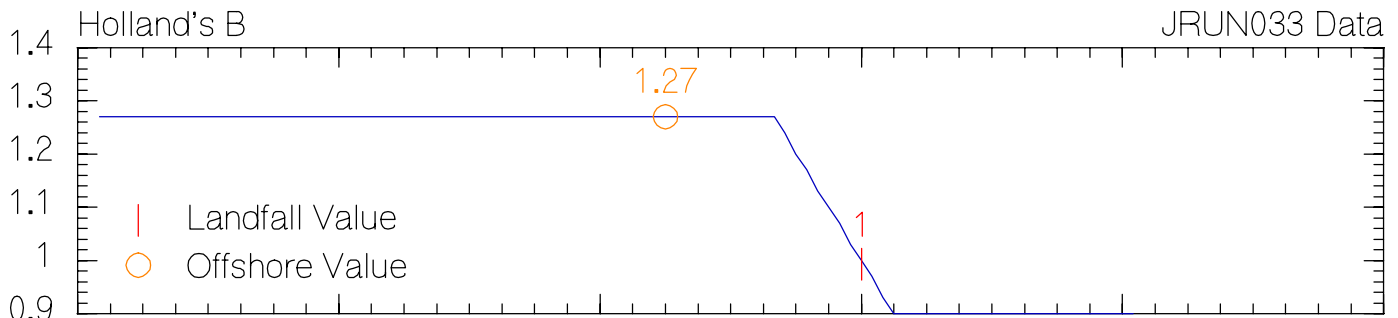
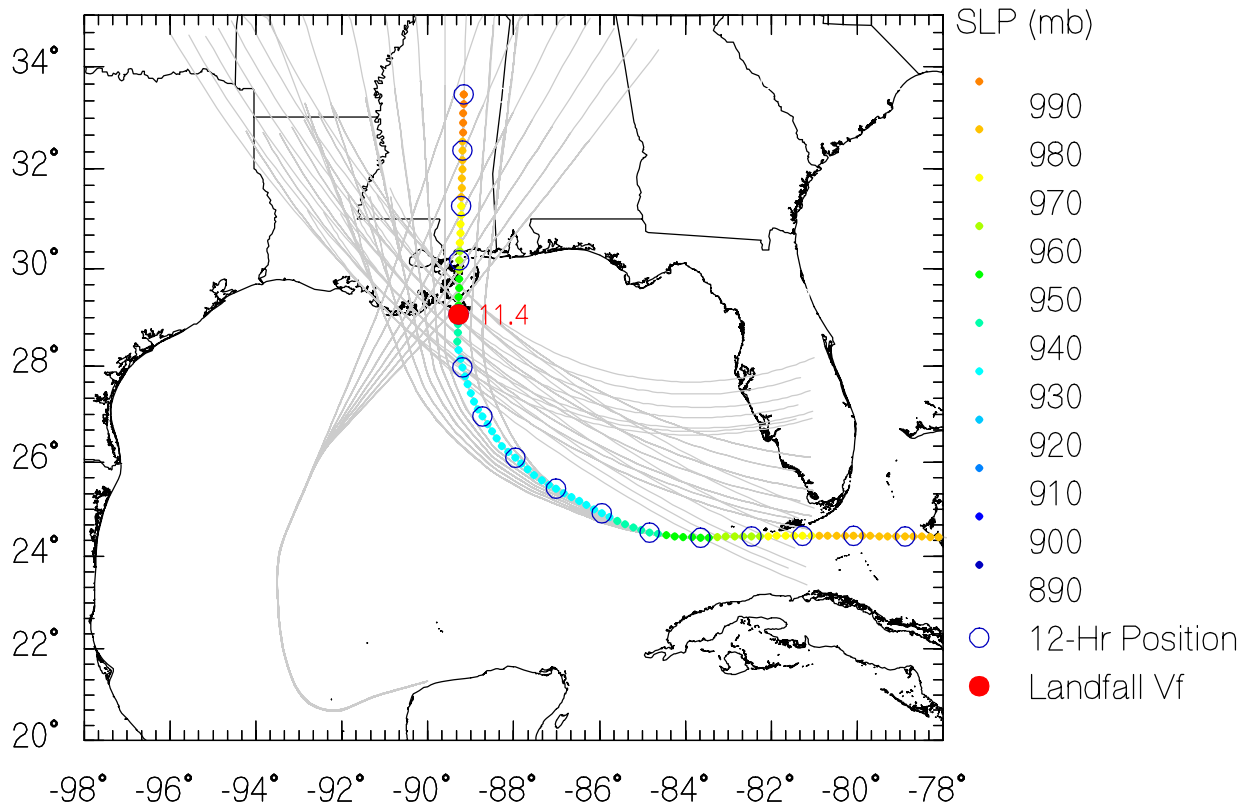

JRUN034 Data

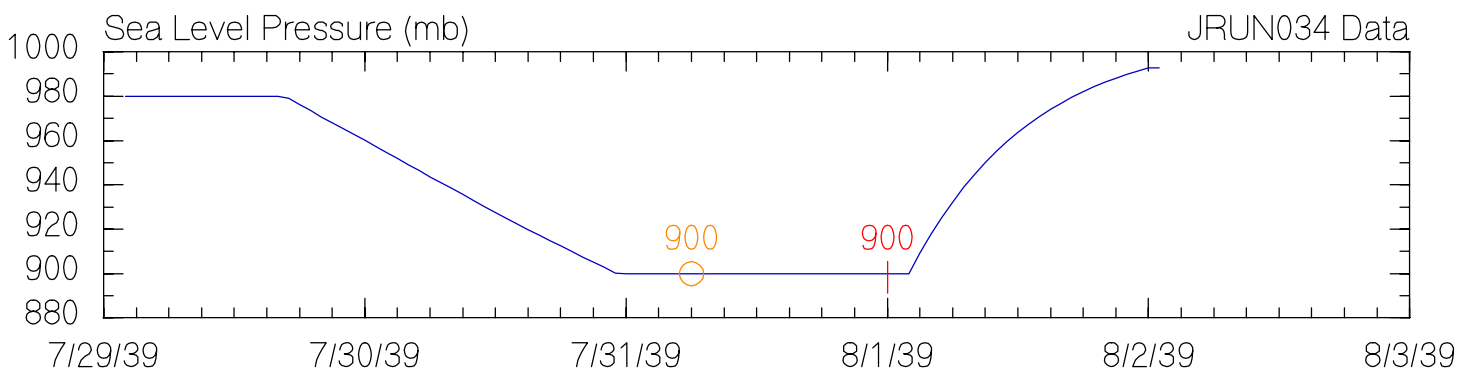
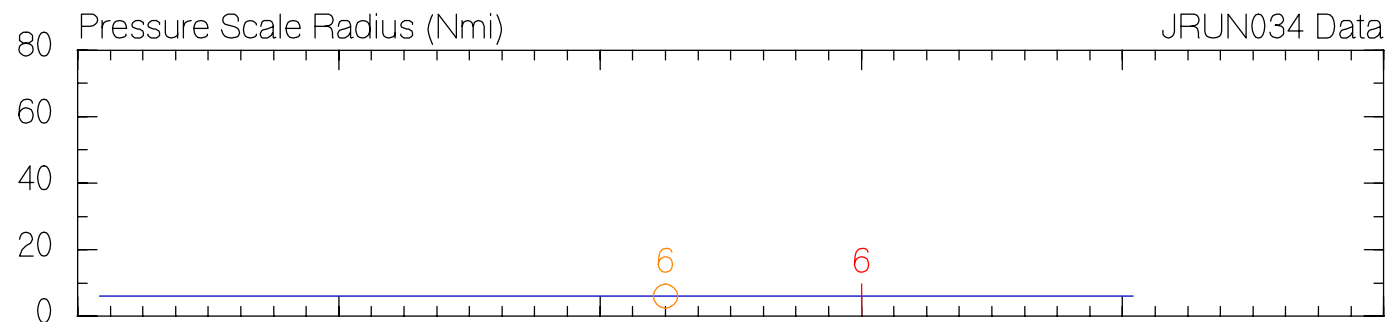
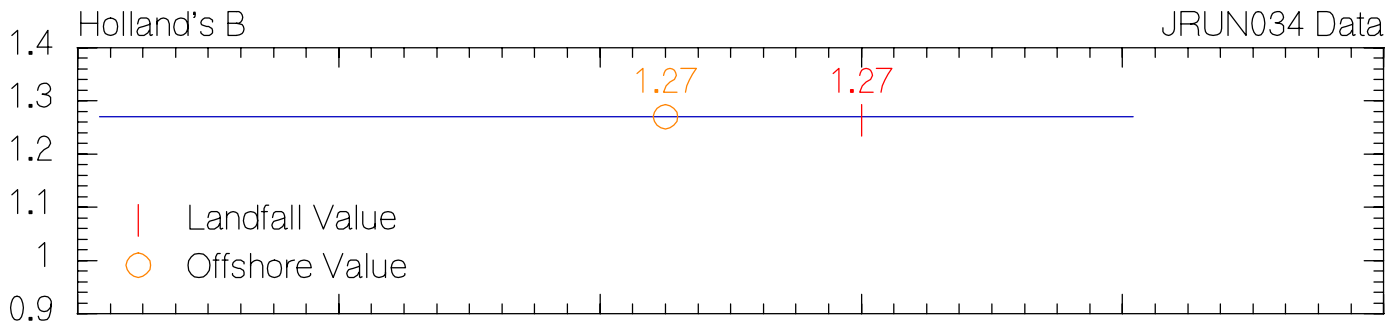
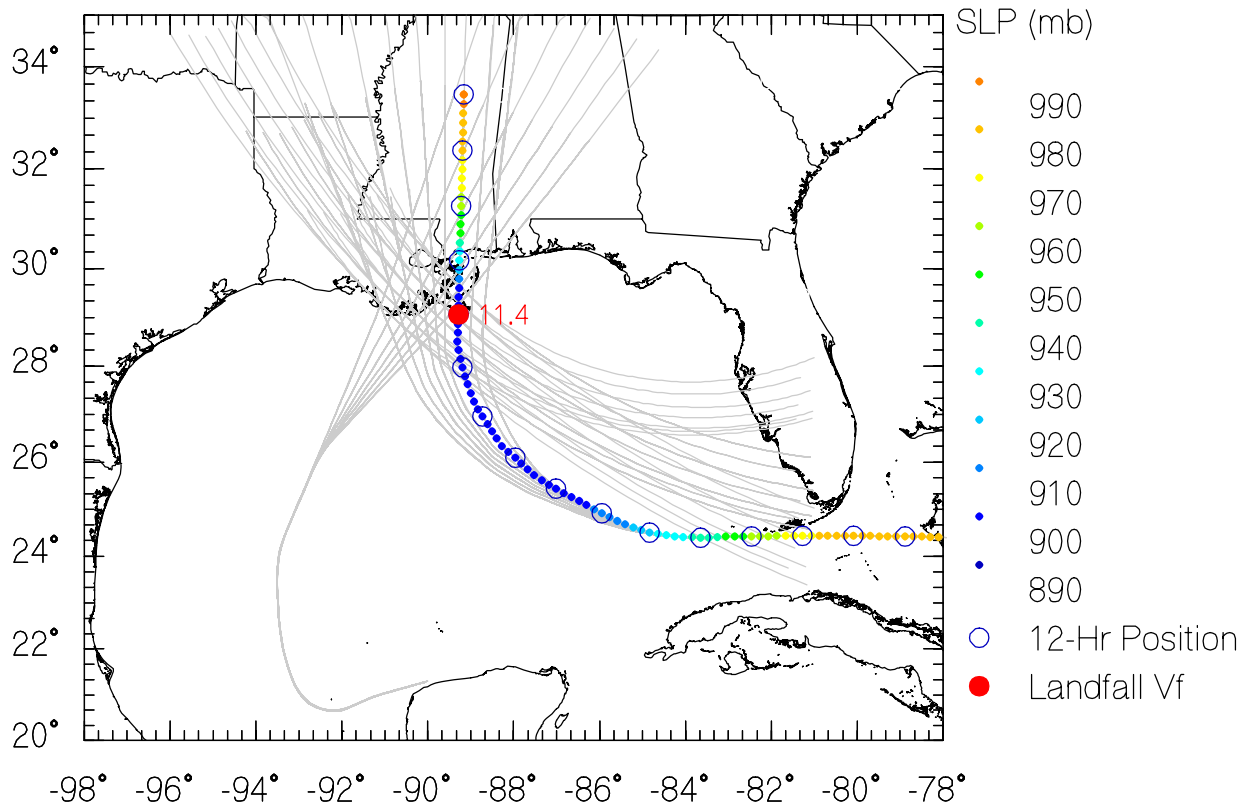

JRUN035 Data

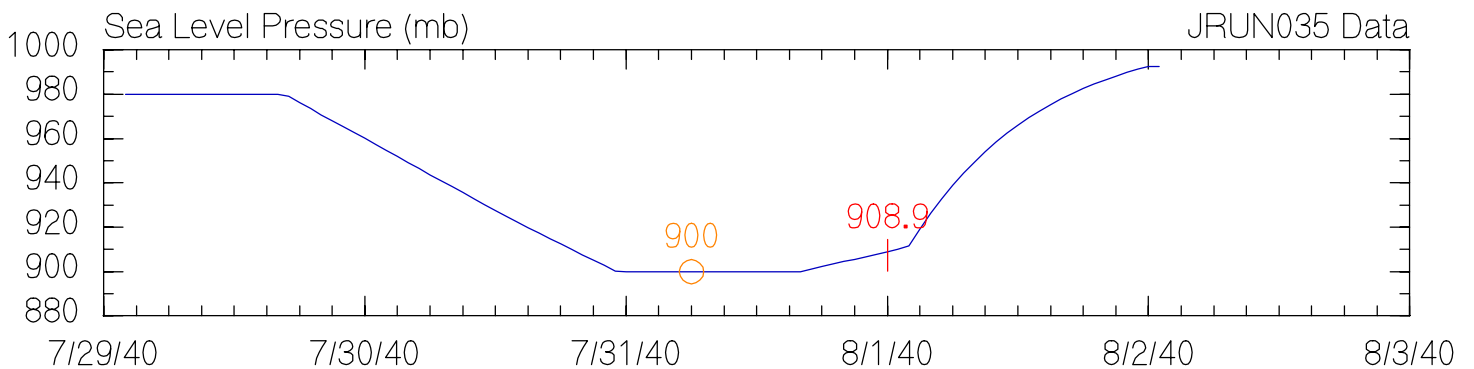
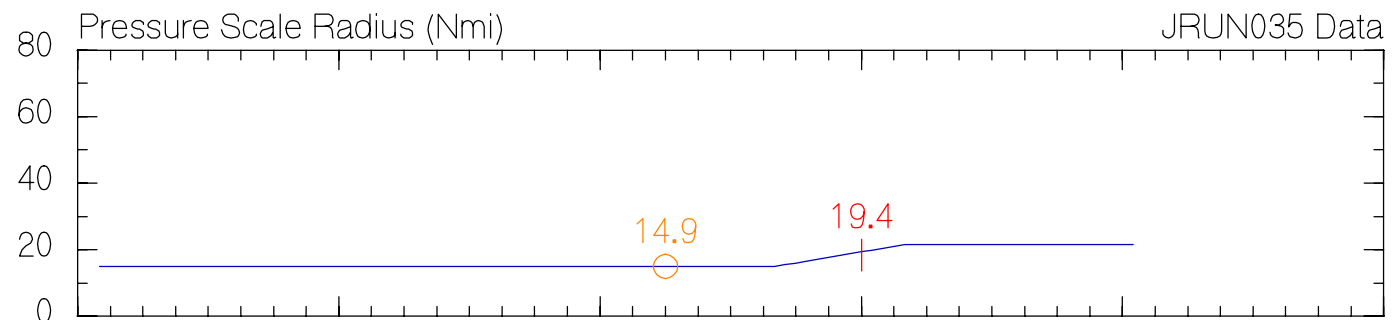
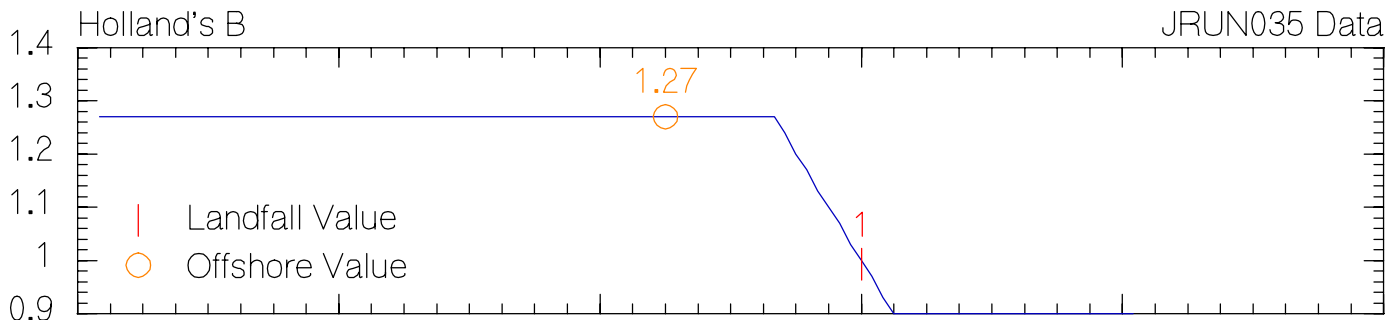
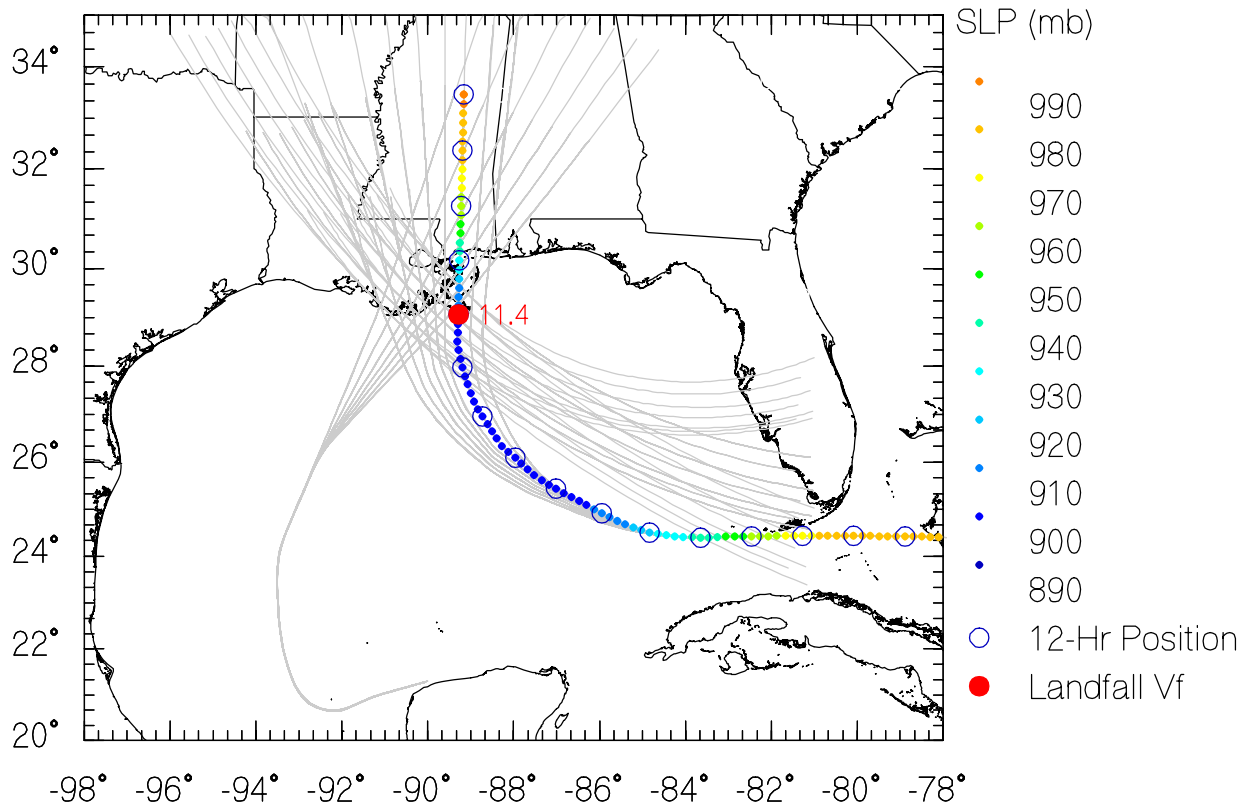

JRUN036 Data

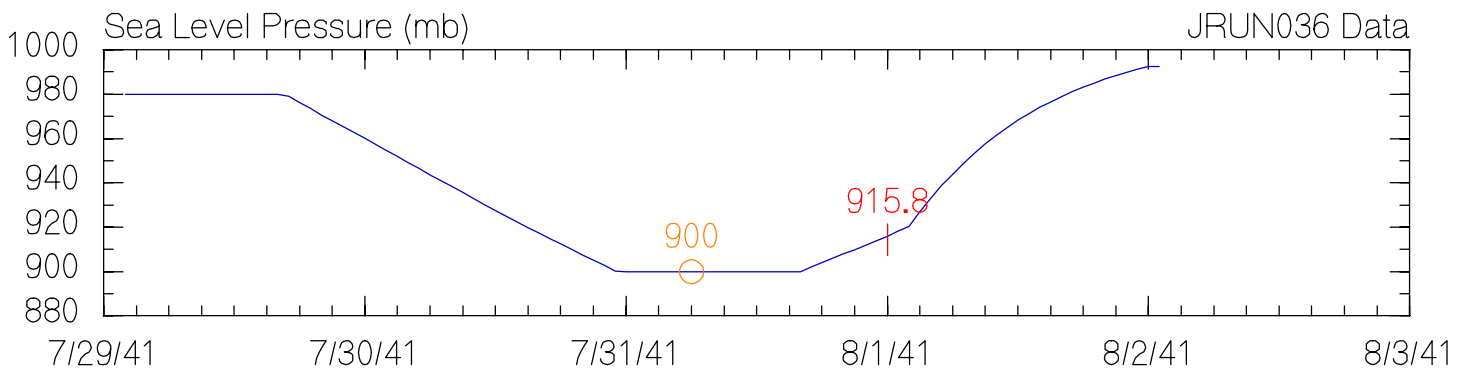
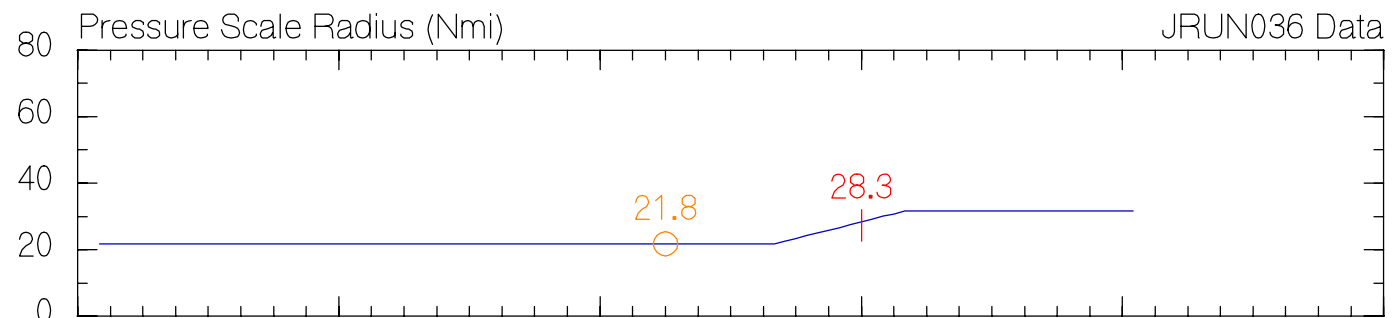
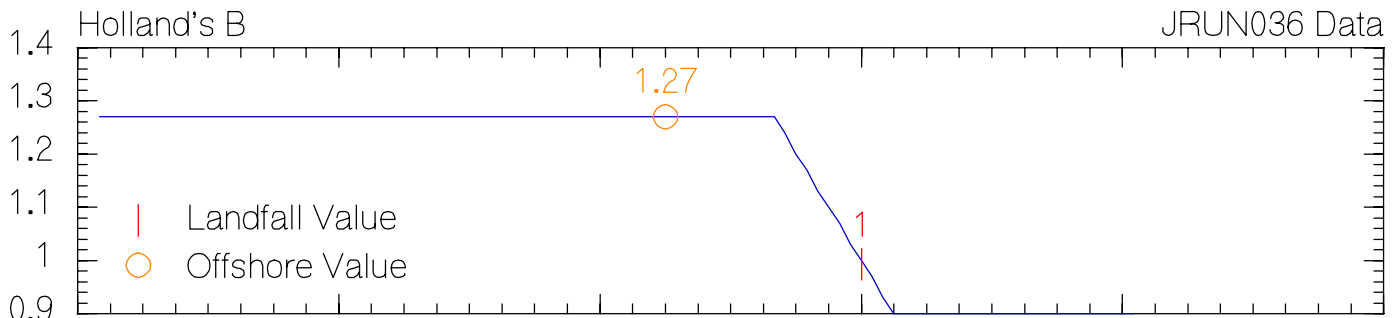
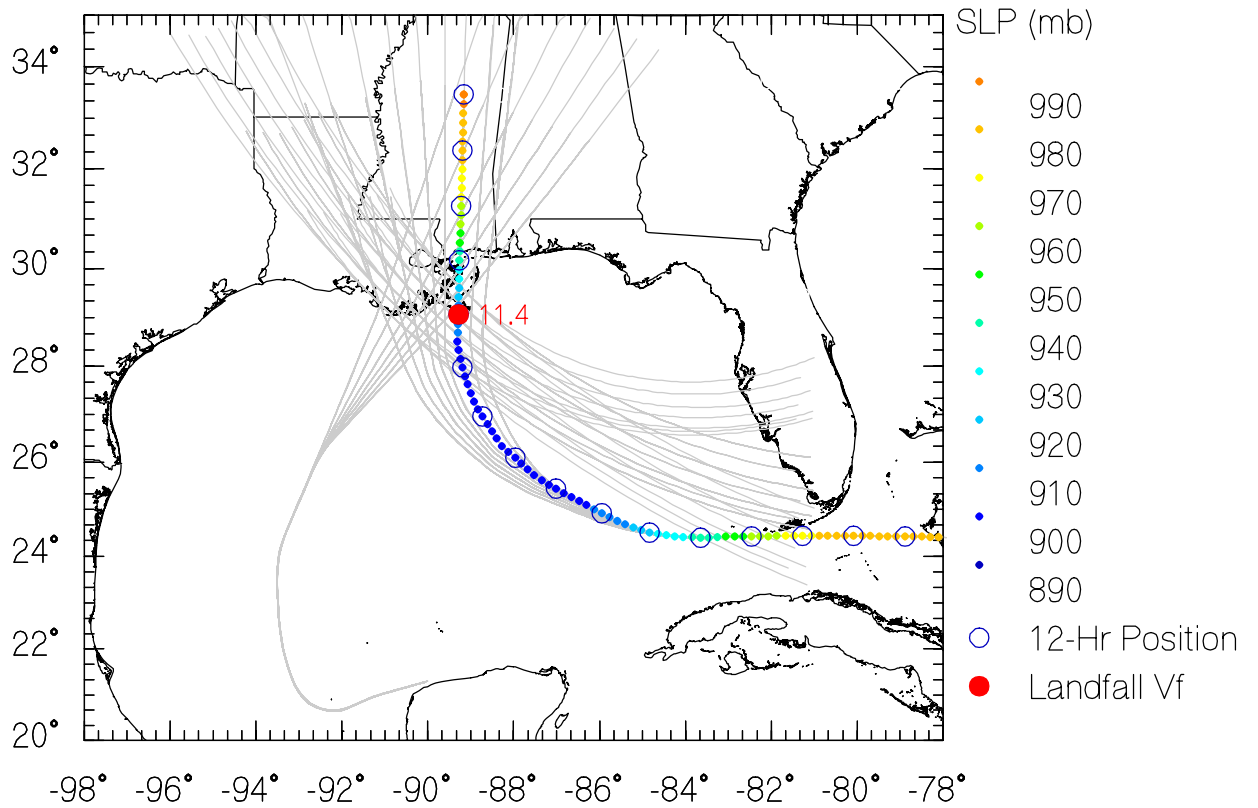

JRUN037 Data

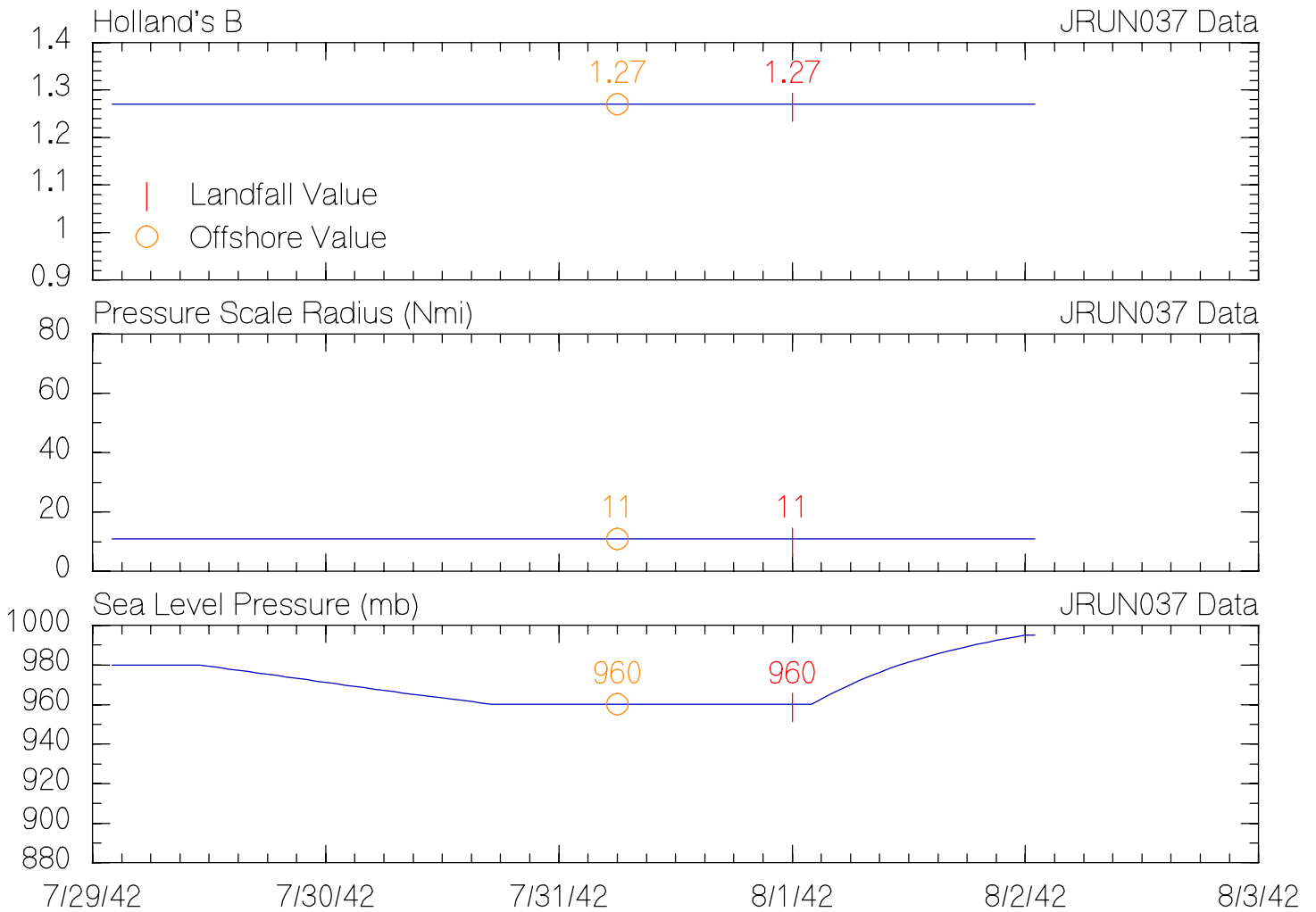
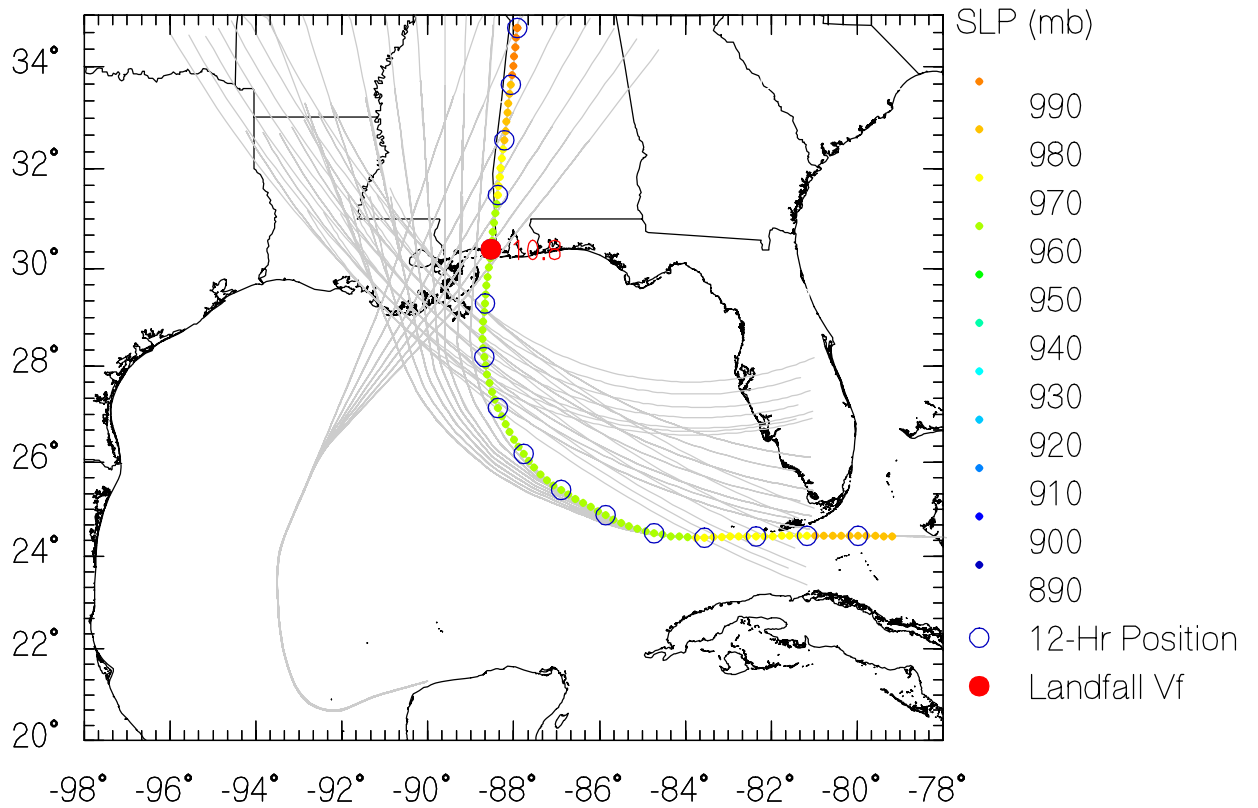

JRUN038 Data

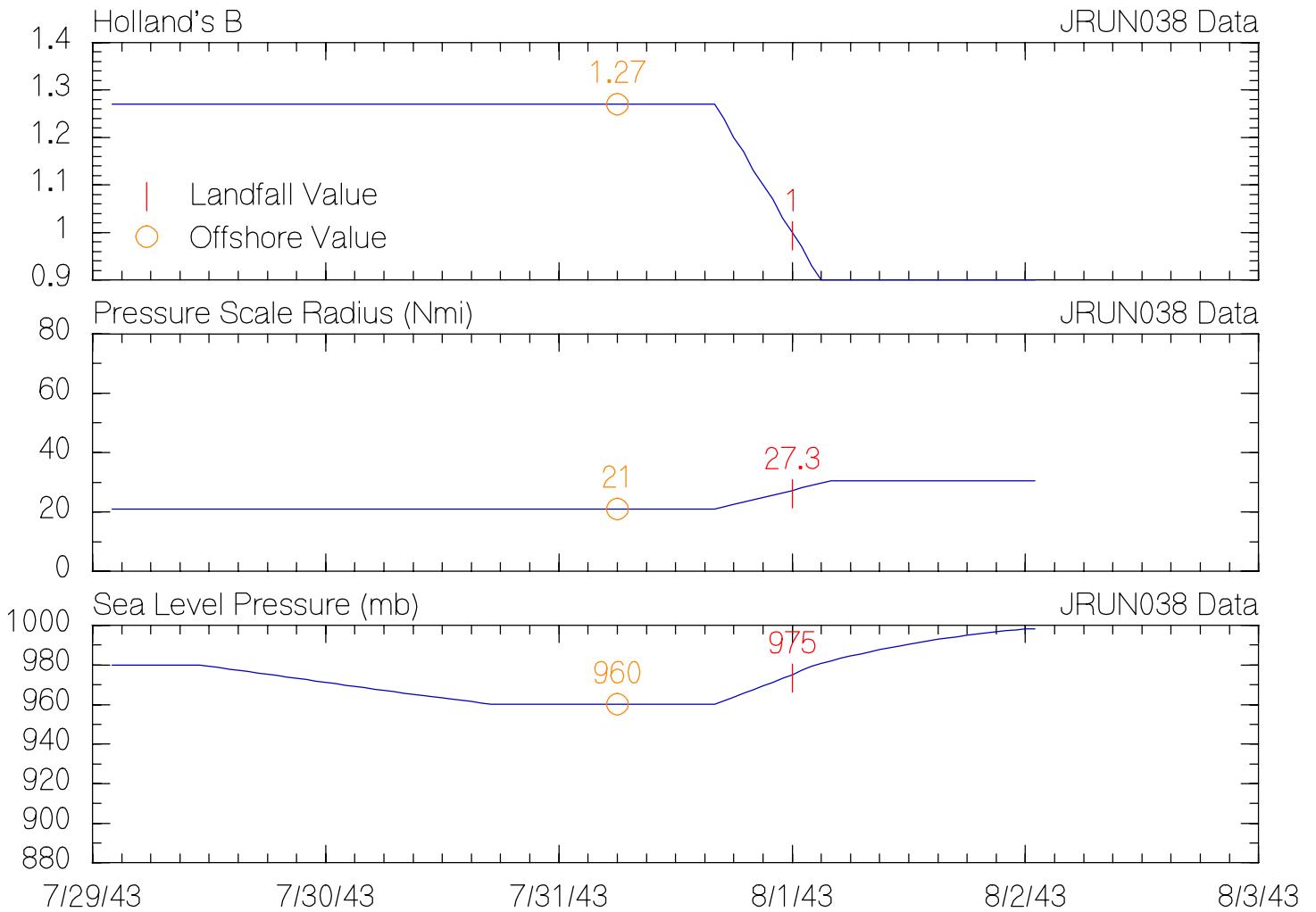
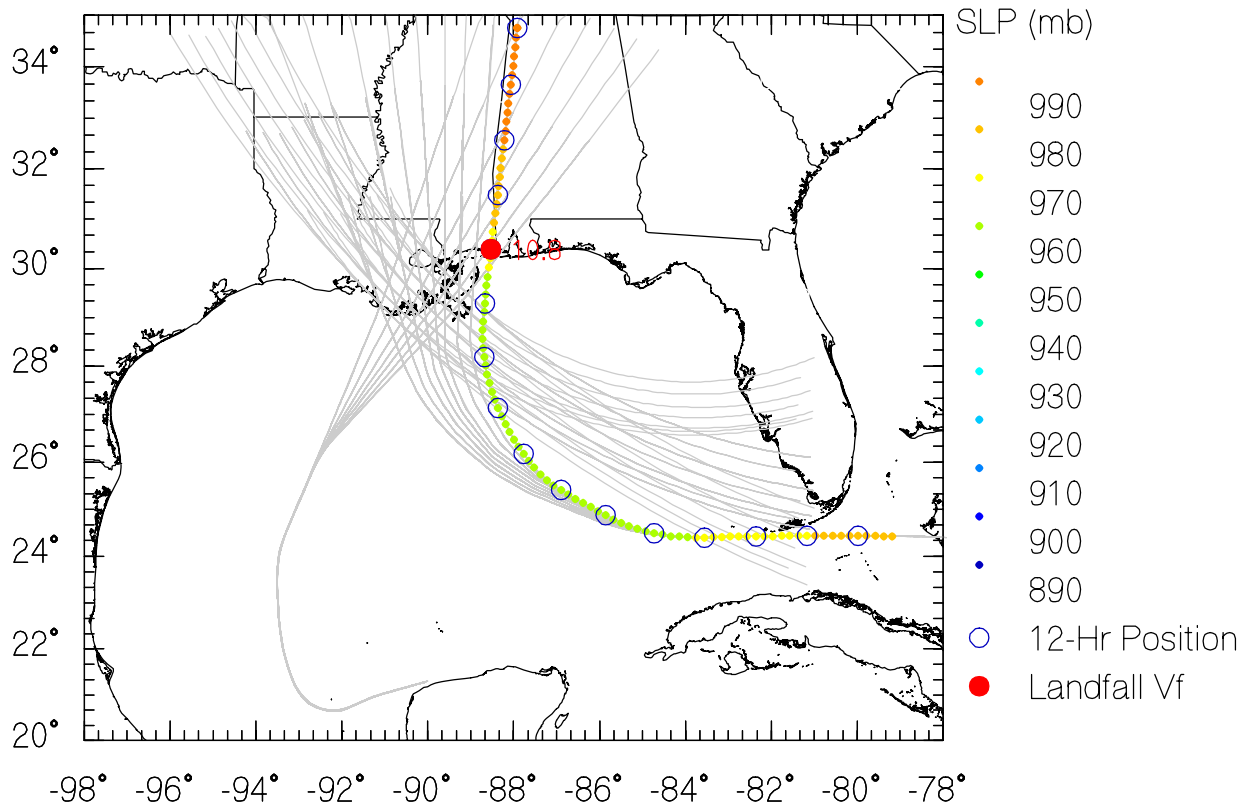

JRUN039 Data

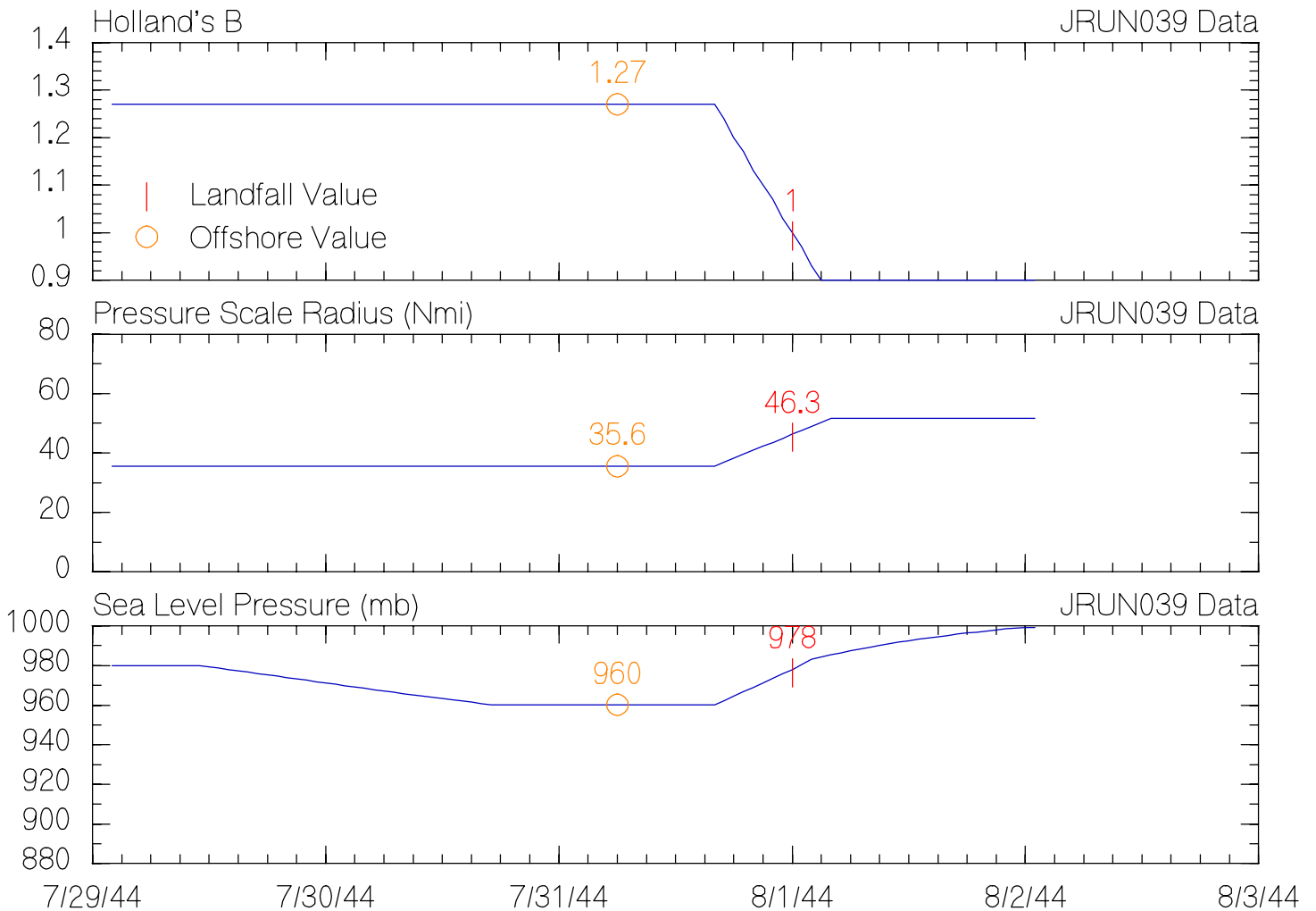
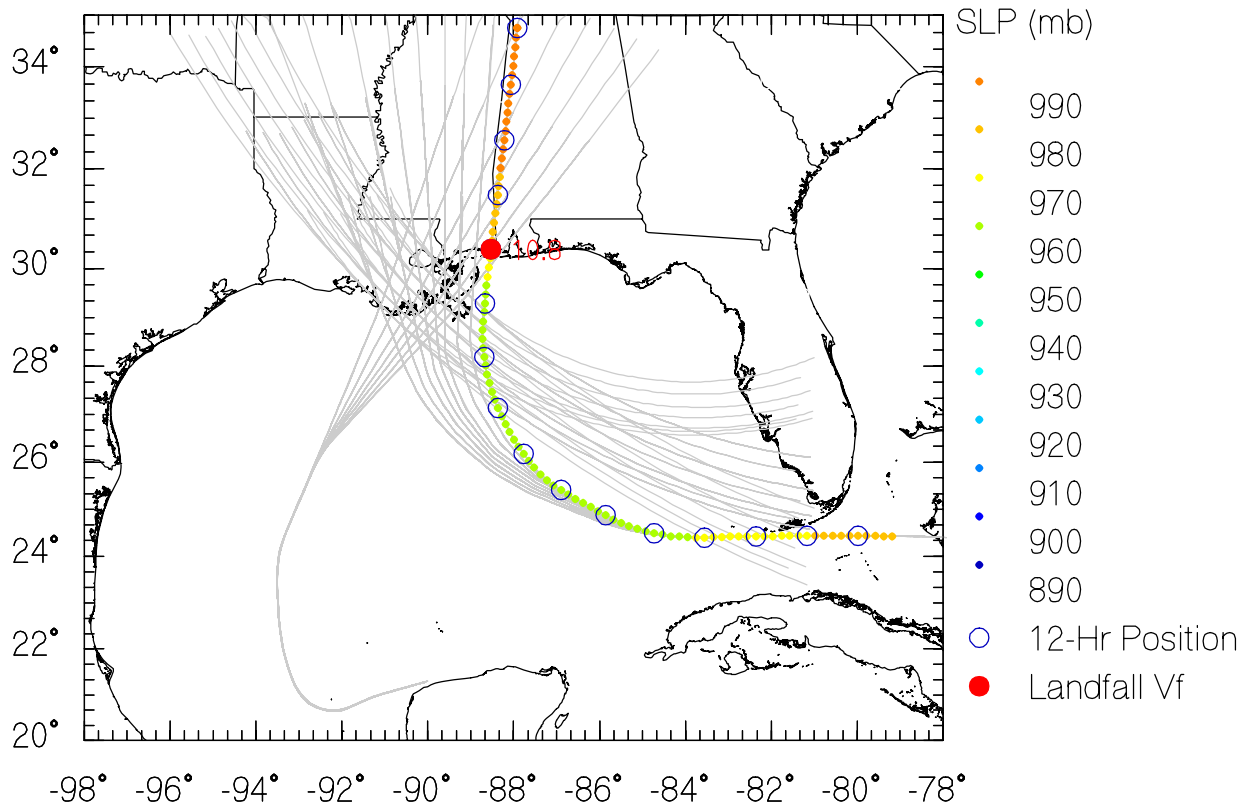

JRUN040 Data

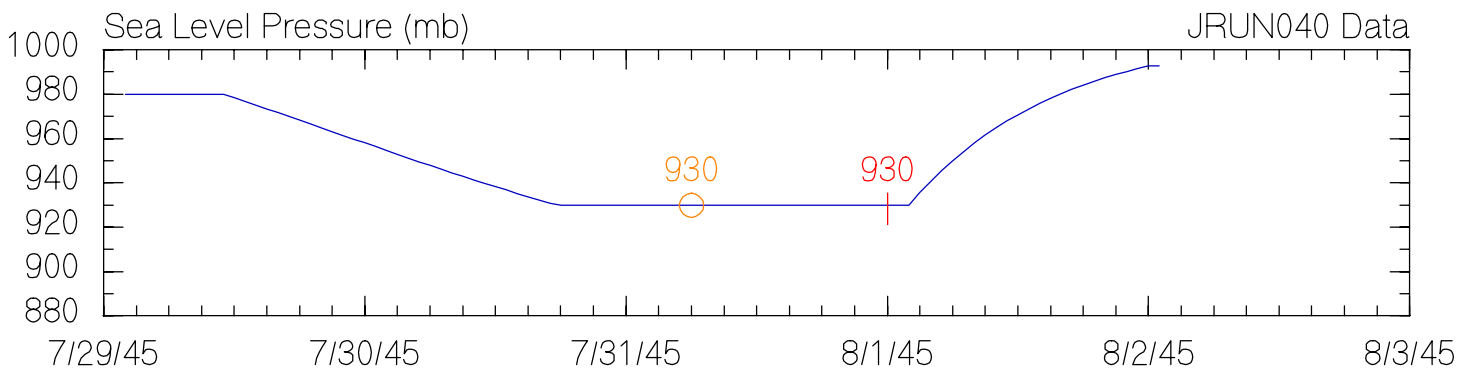
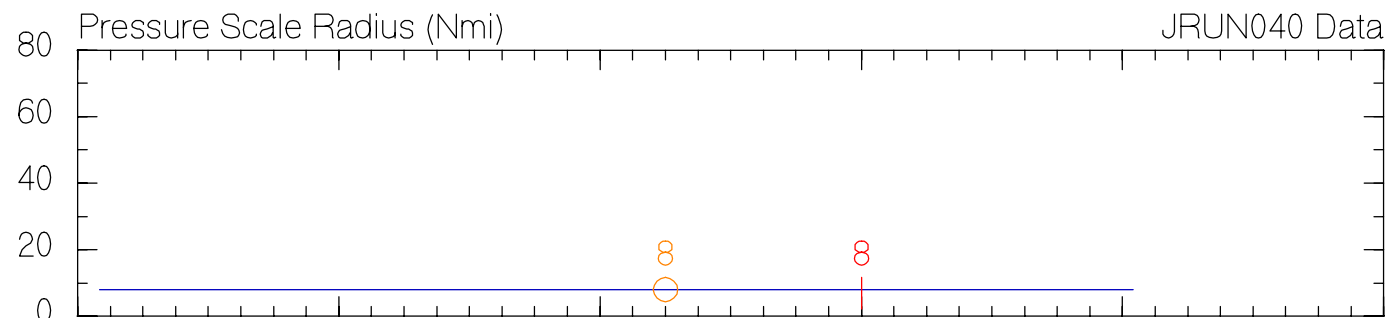
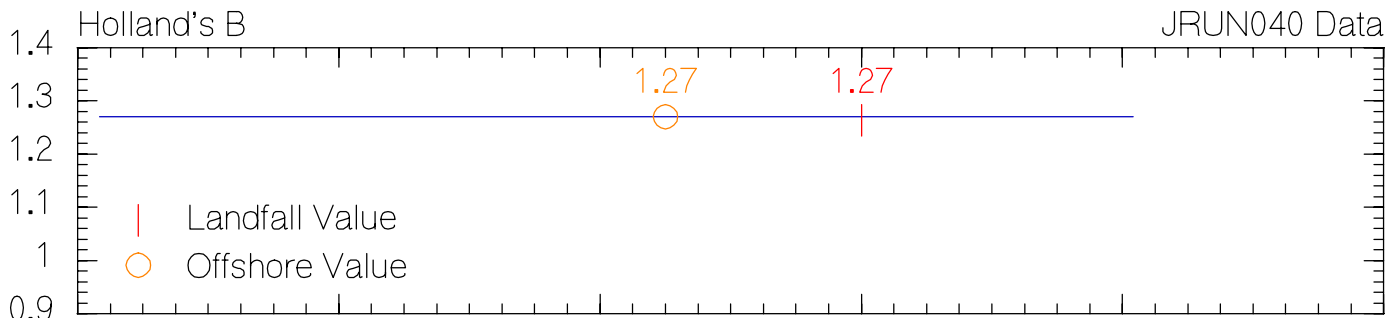
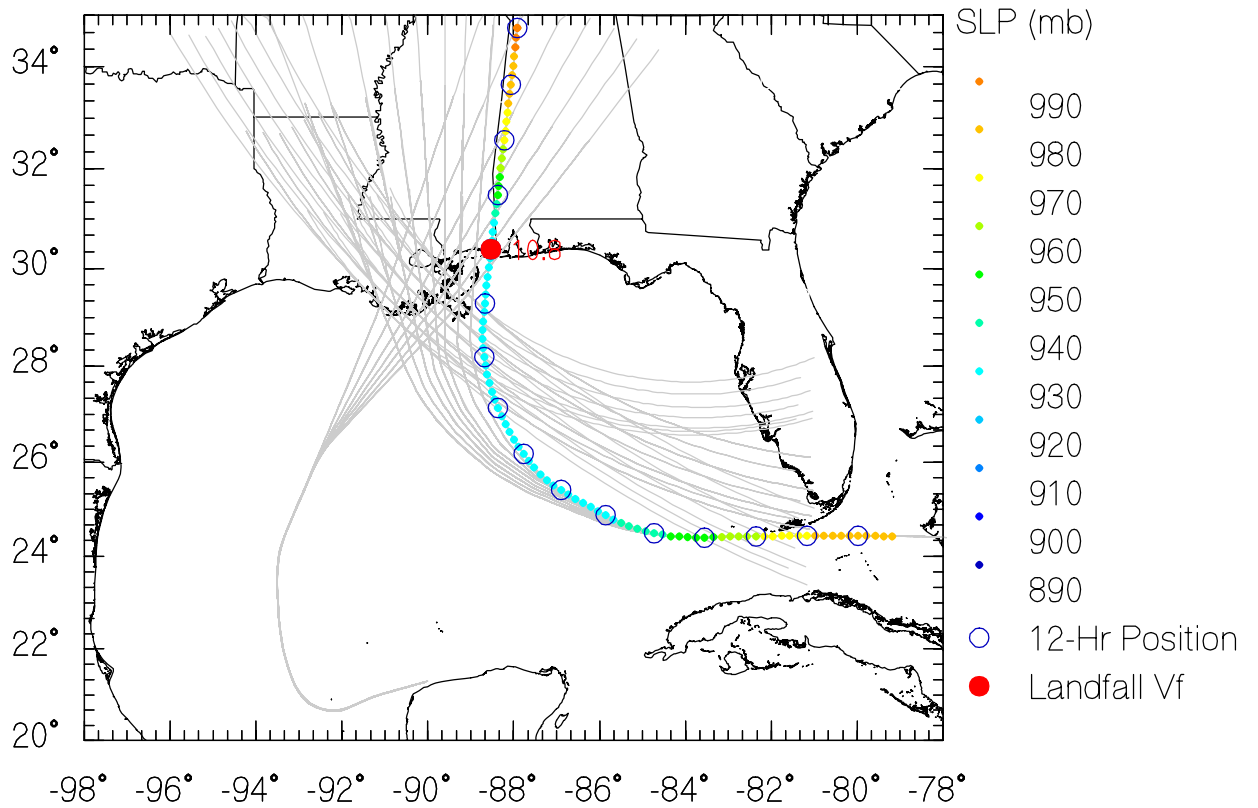

JRUN041 Data

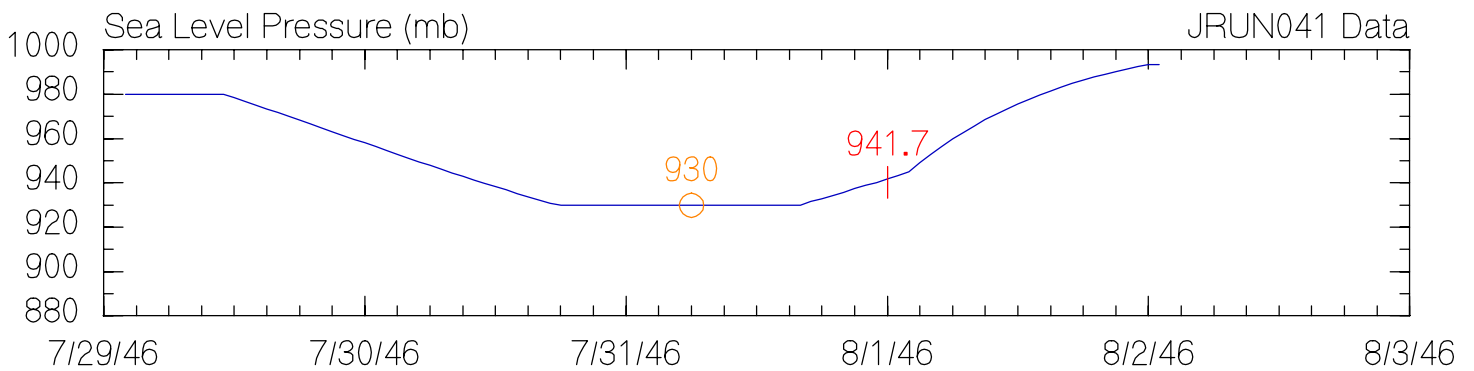
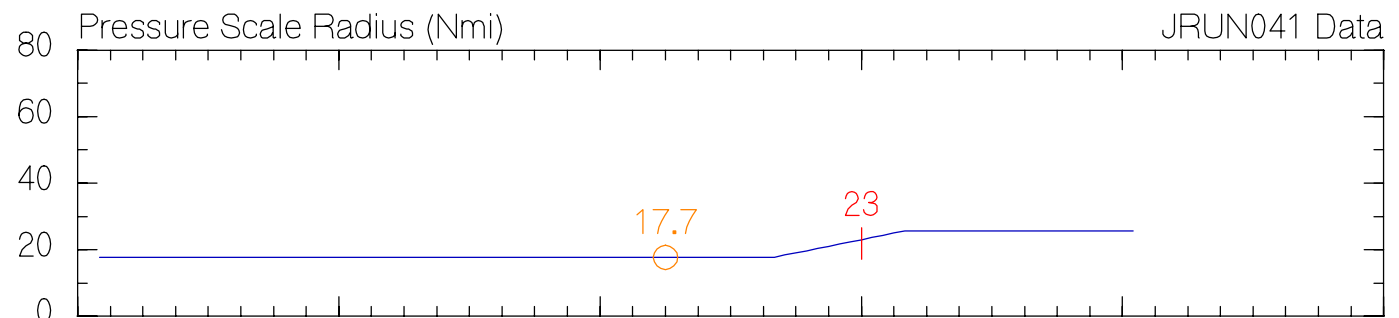
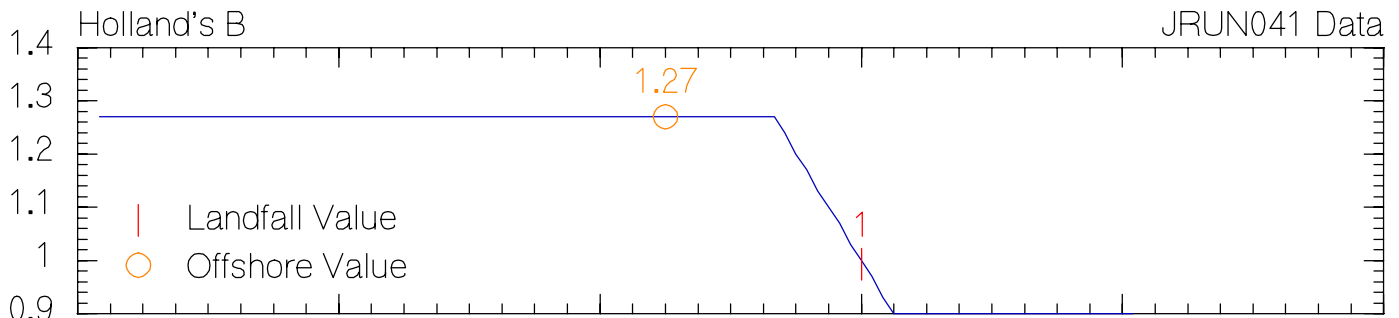
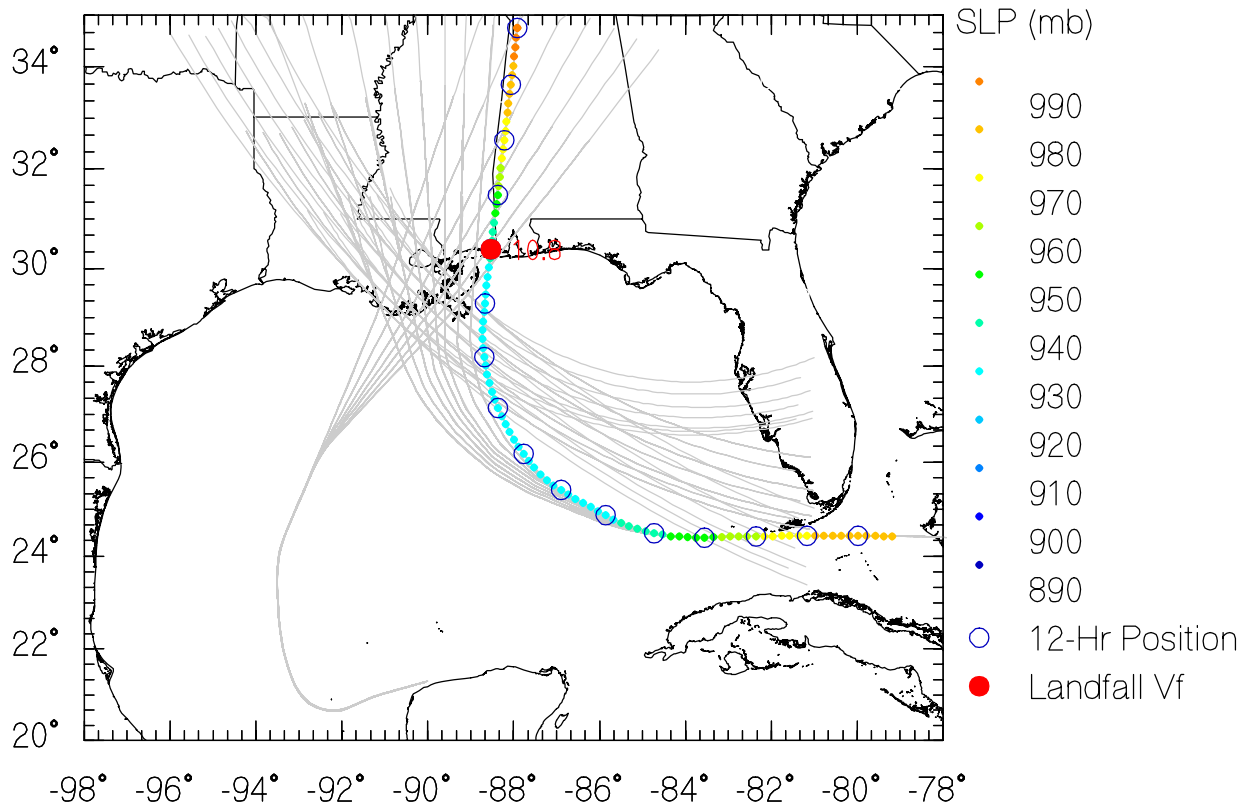

JRUN042 Data

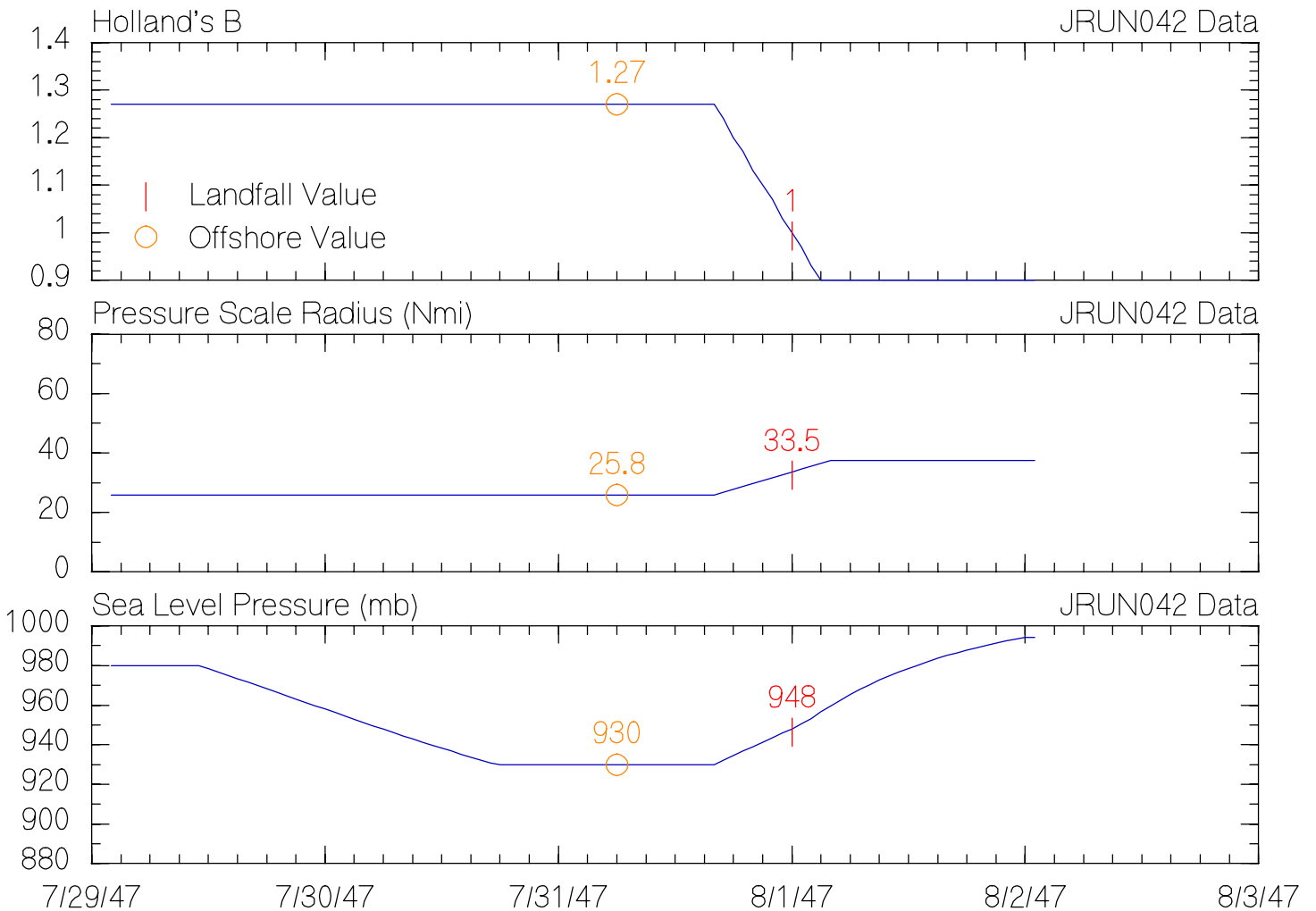
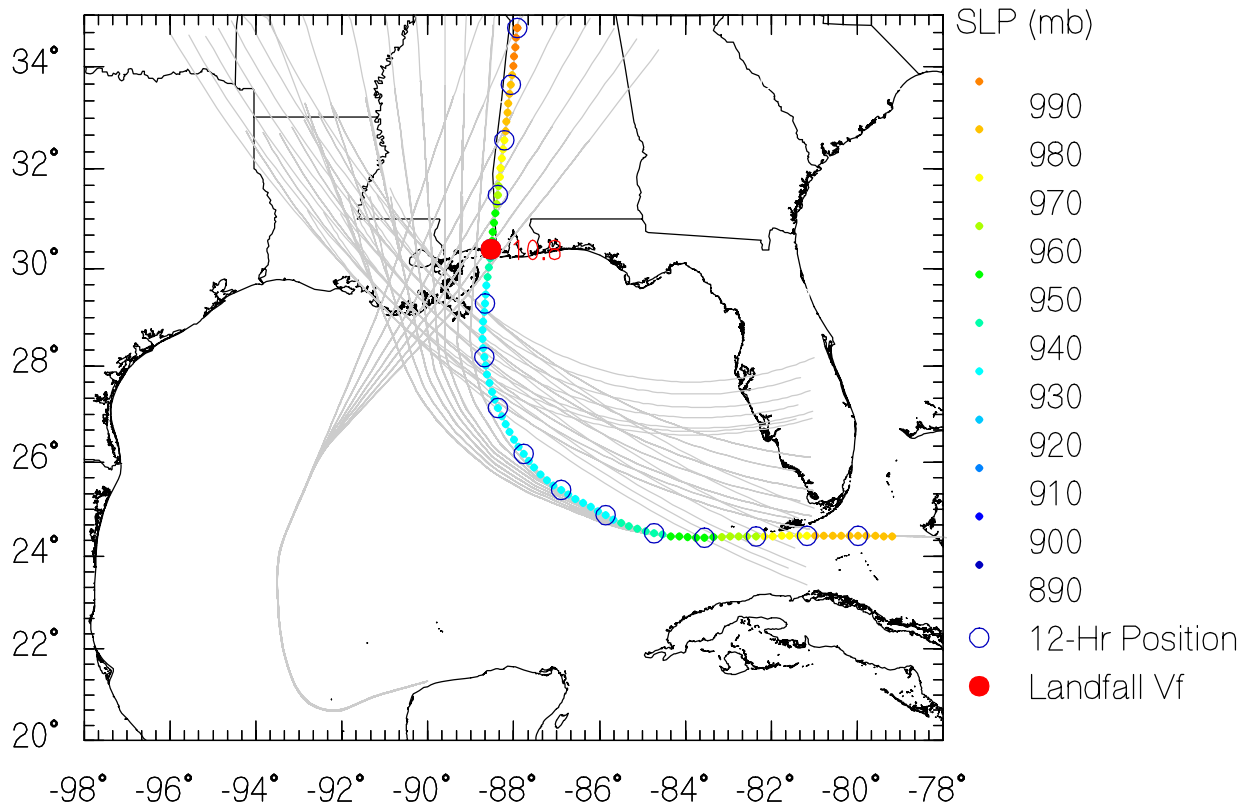

JRUN043 Data

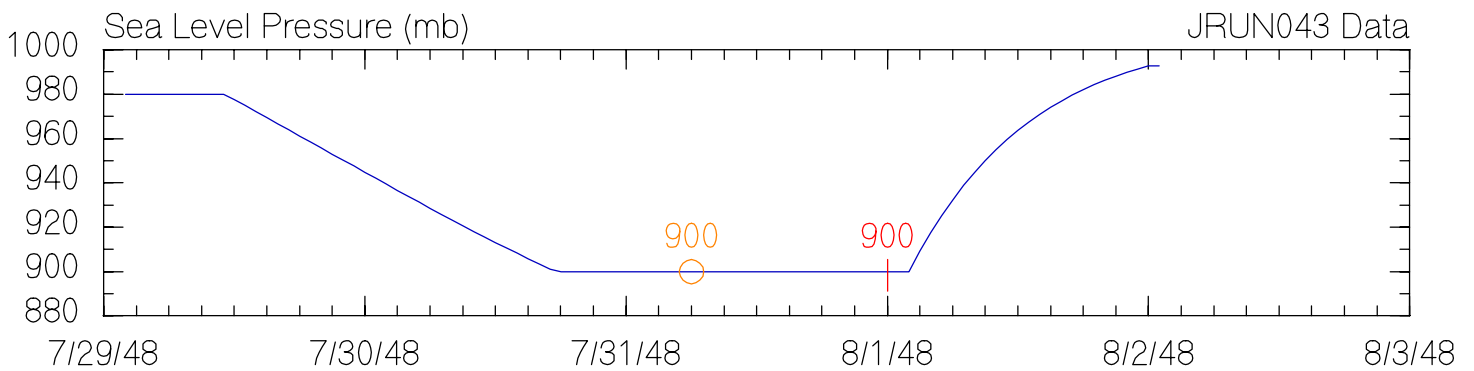
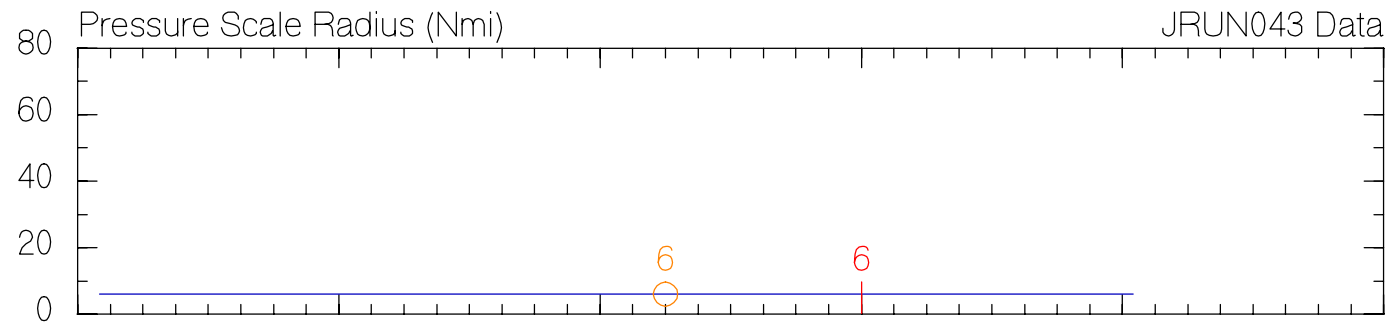
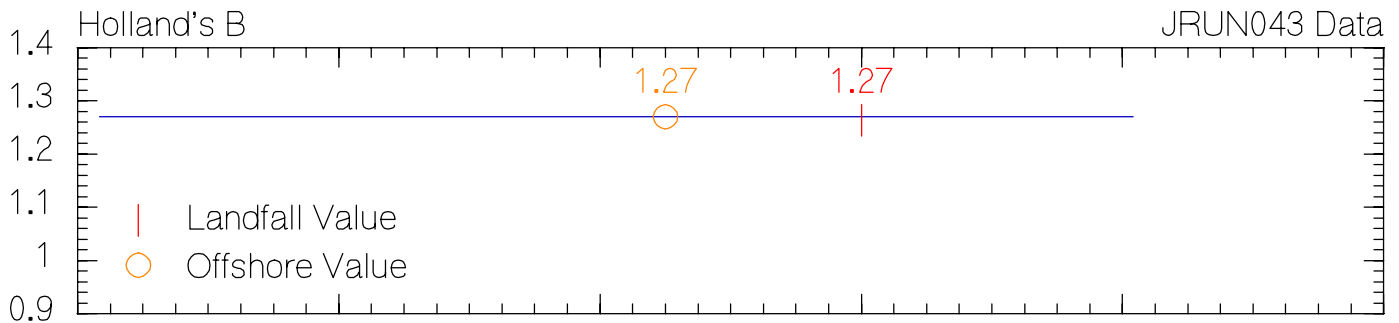
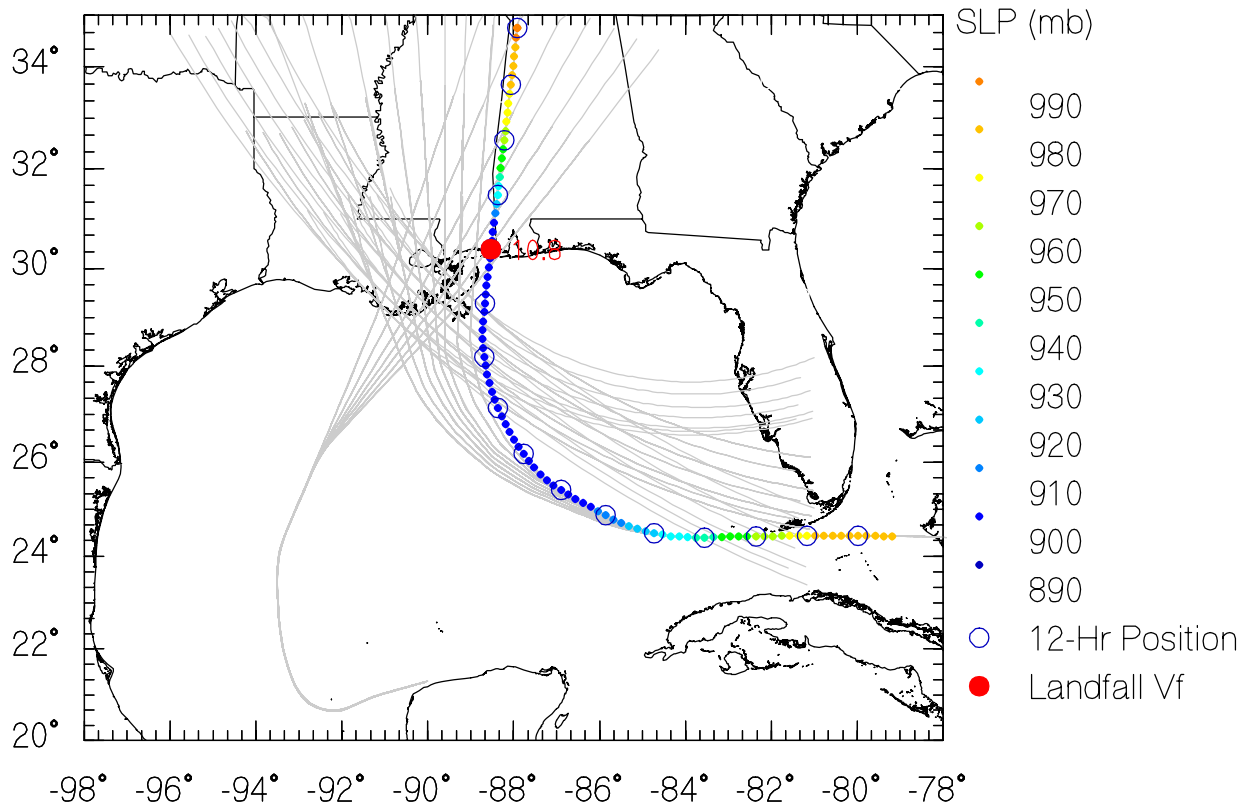

JRUN044 Data

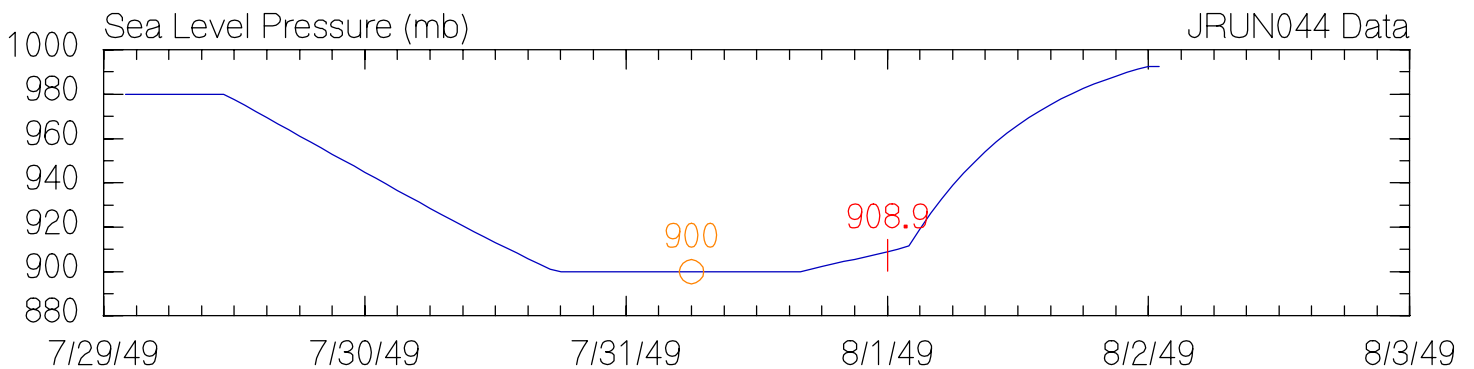
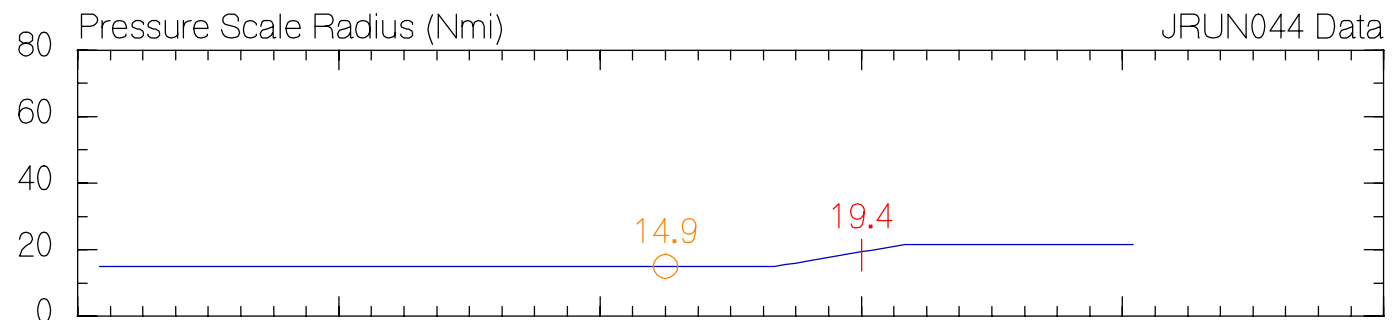
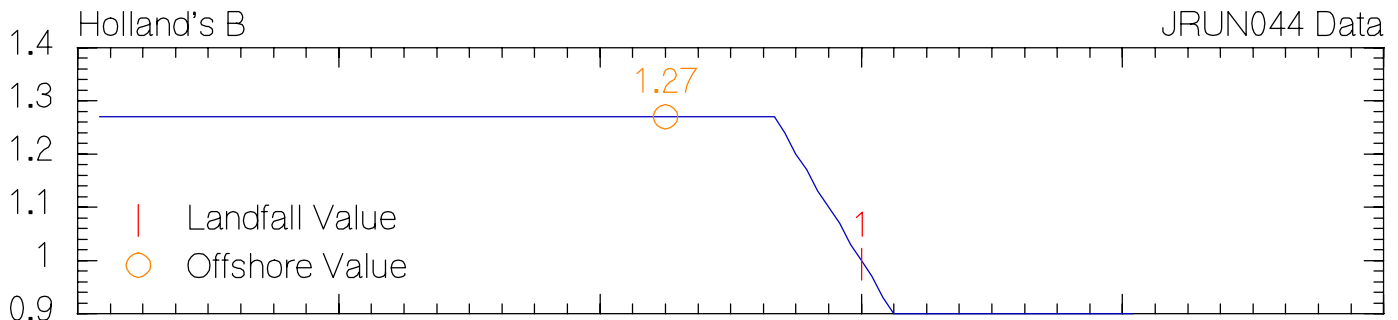
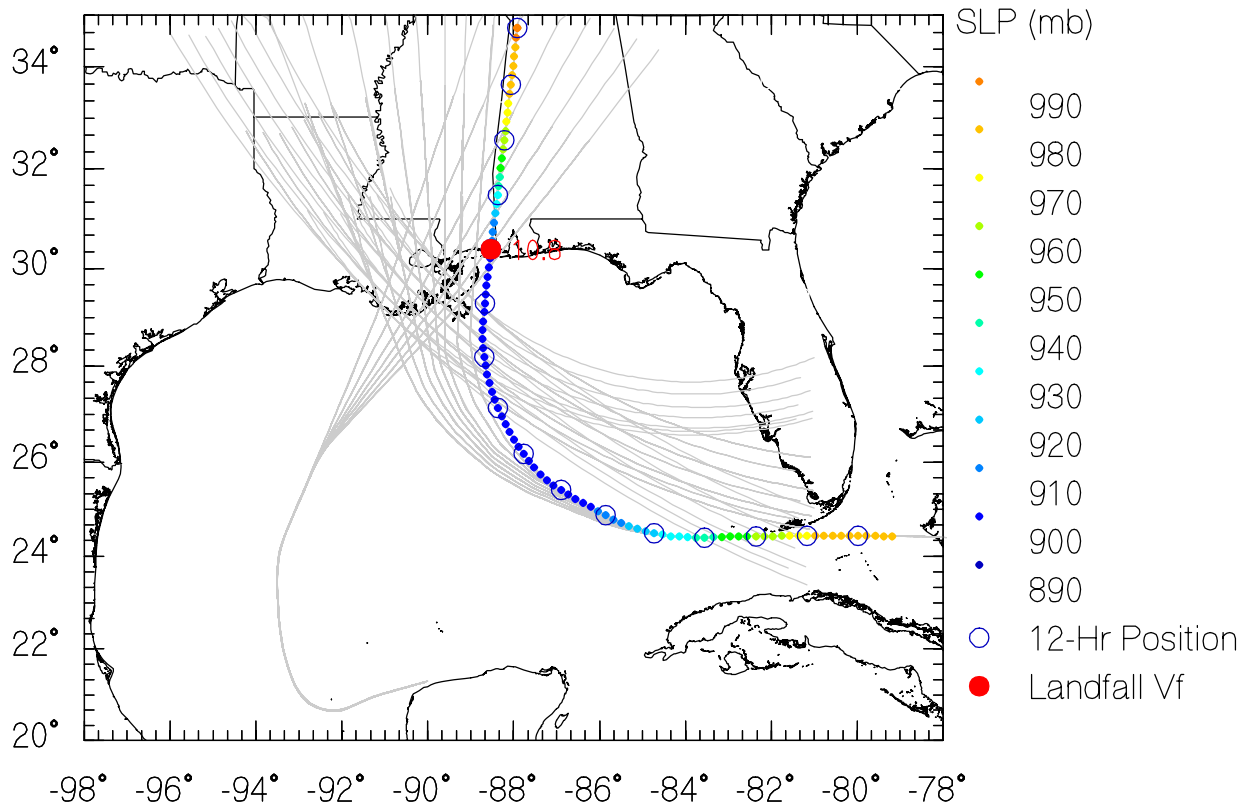

JRUN045 Data

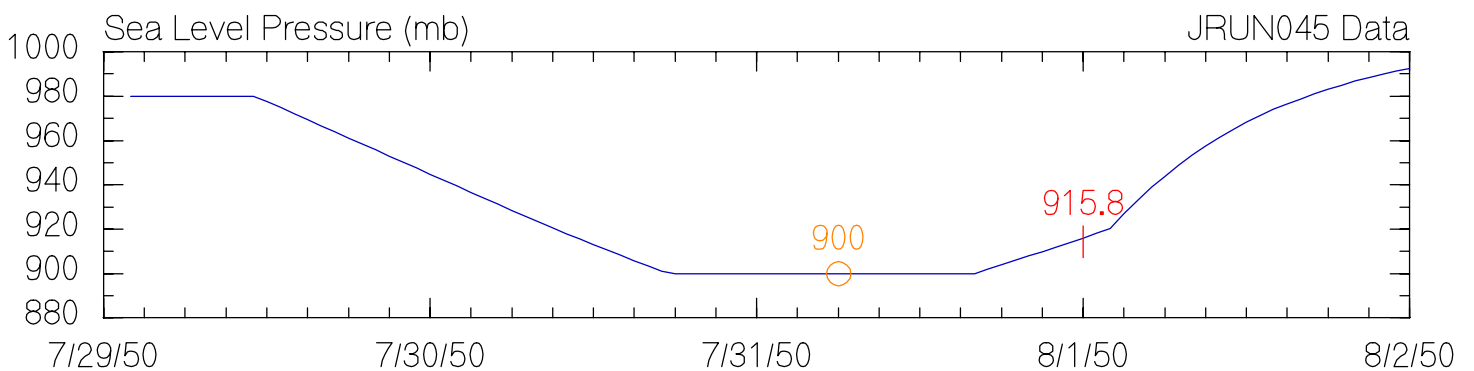
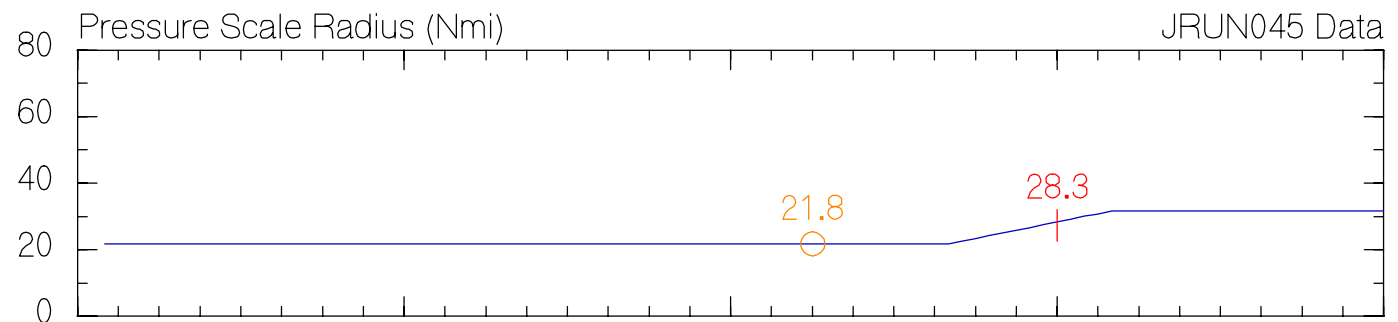
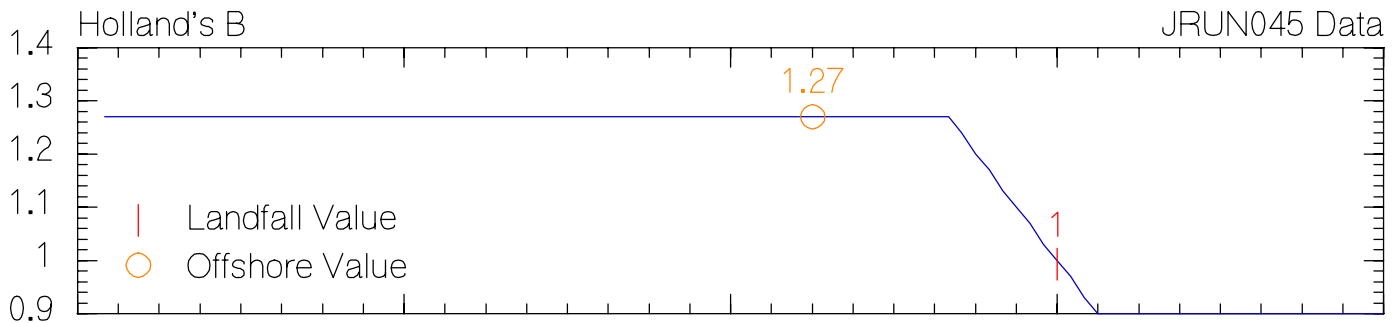
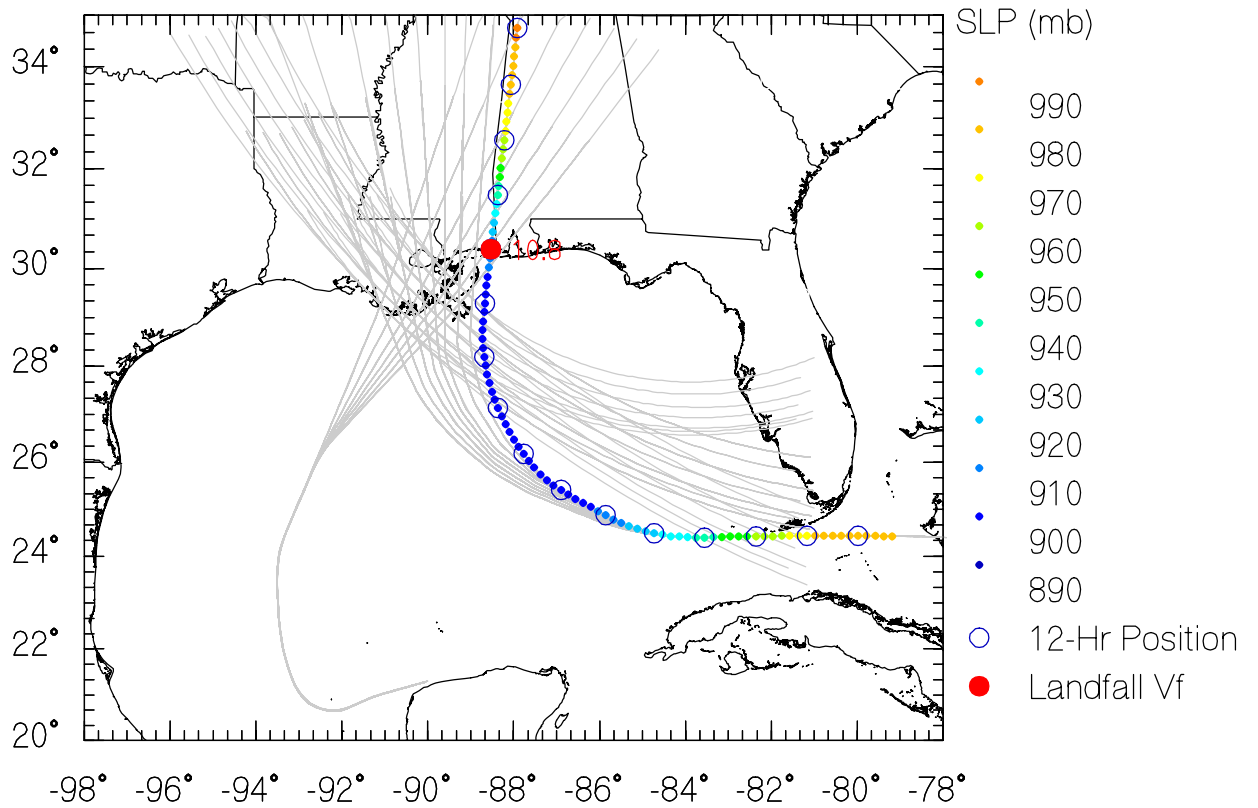

JRUN046 Data

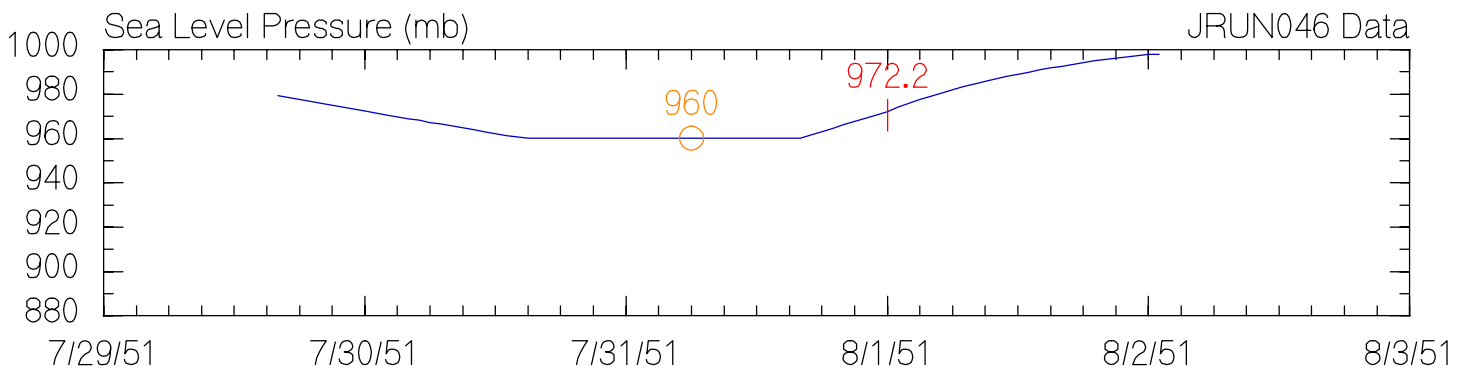
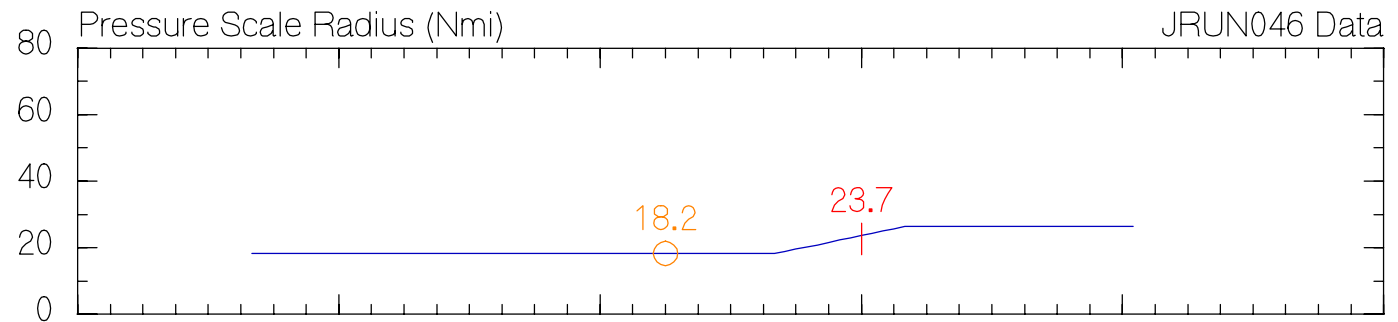
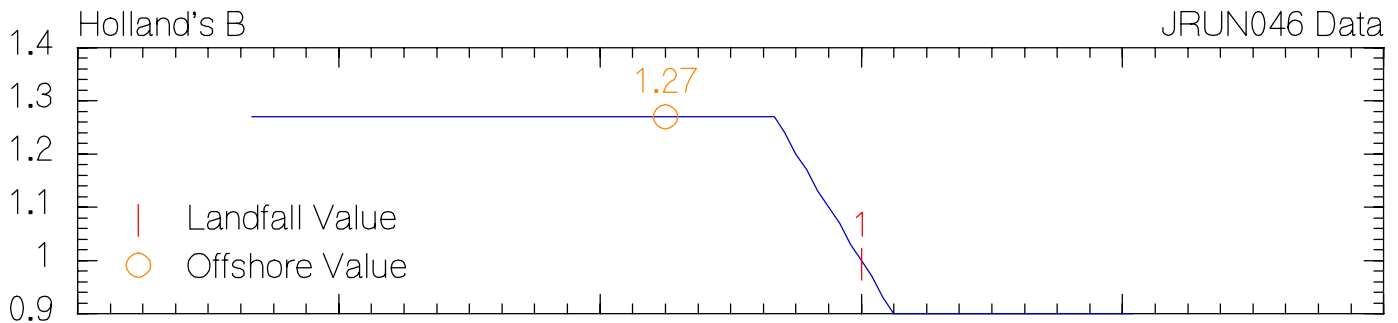
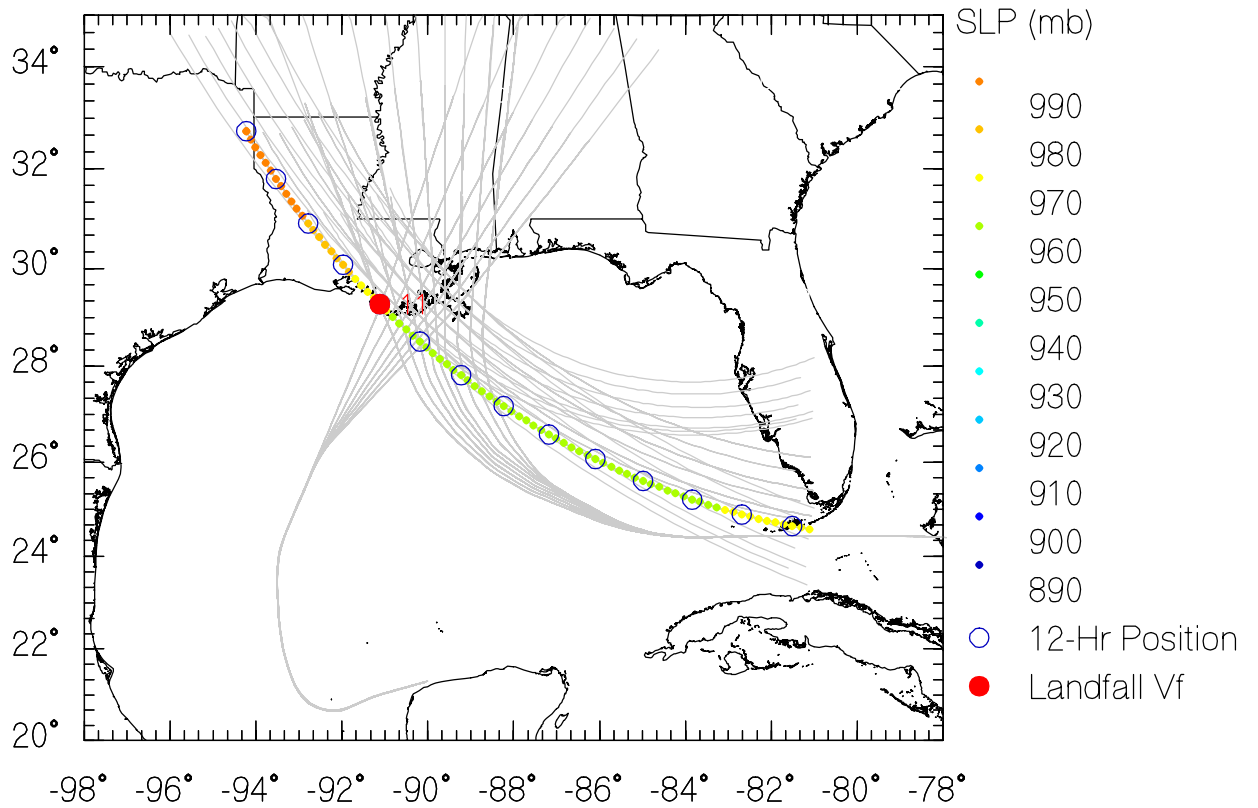

JRUN047 Data

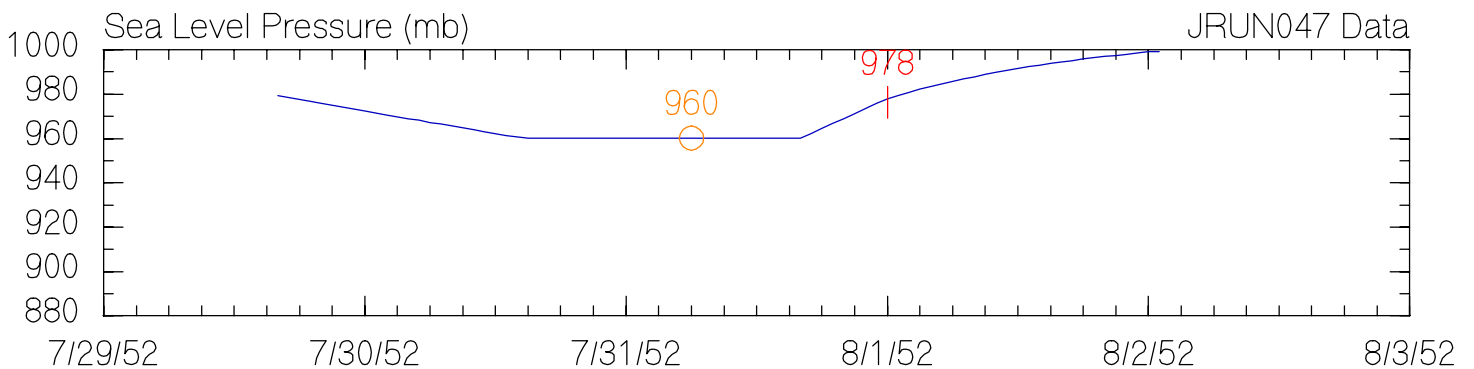
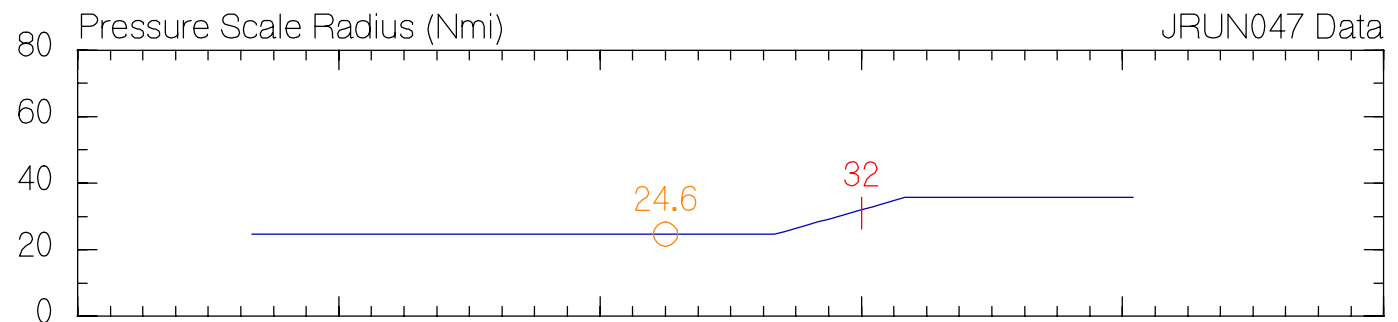
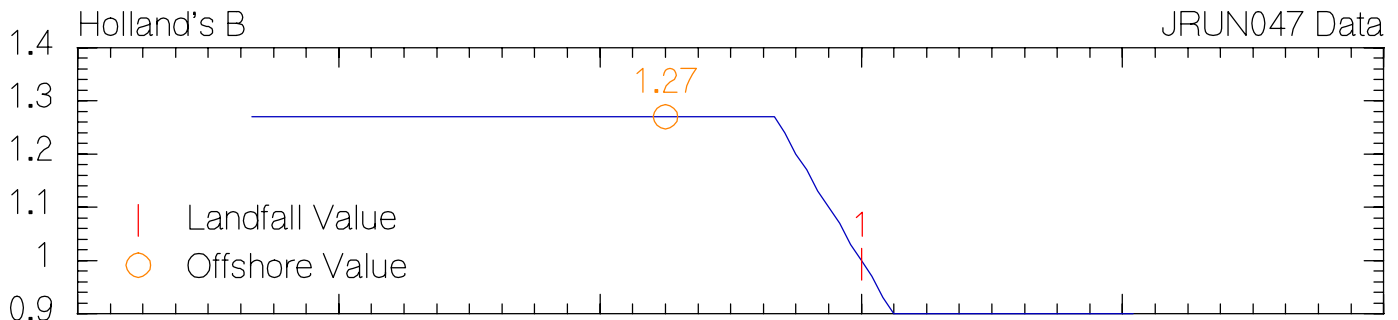
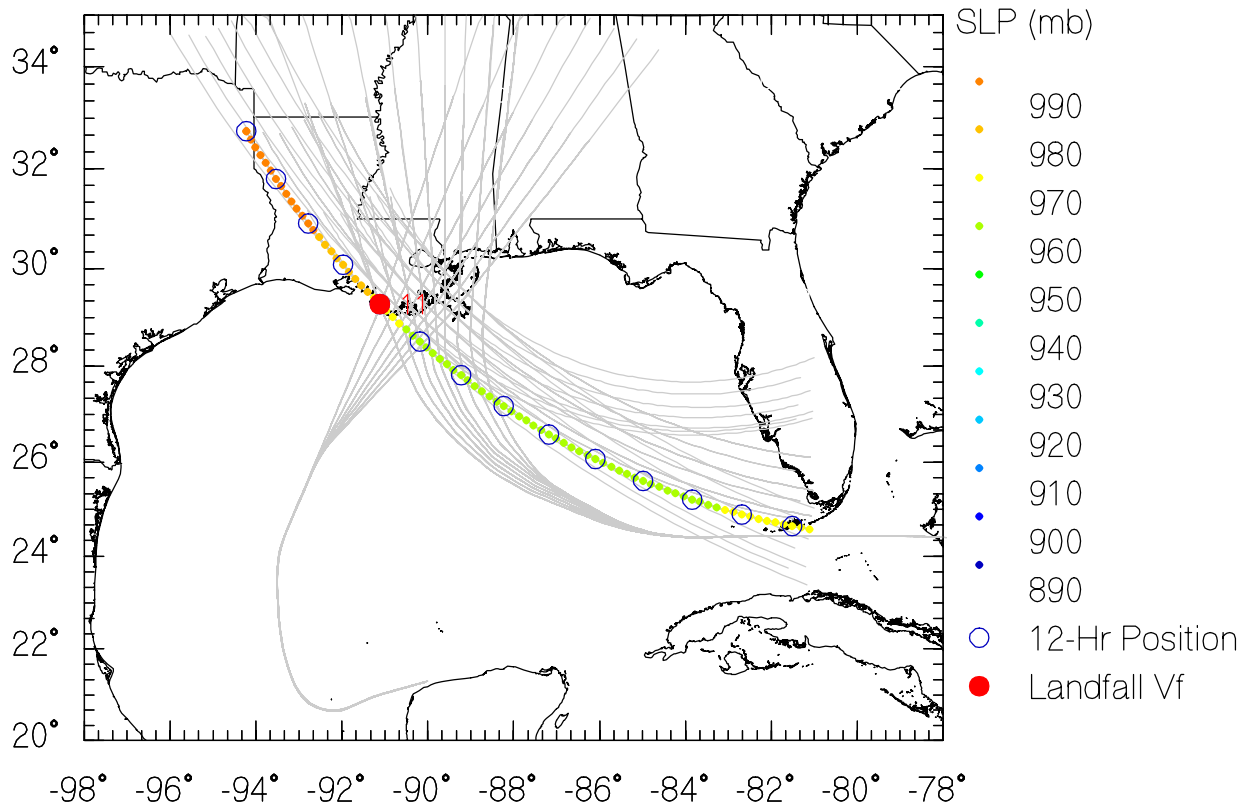

JRUN048 Data

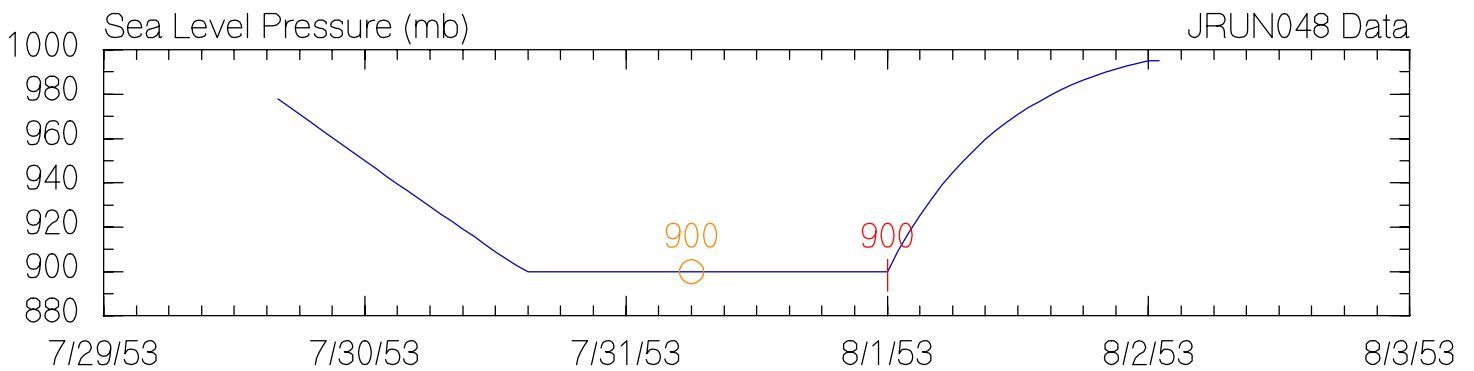
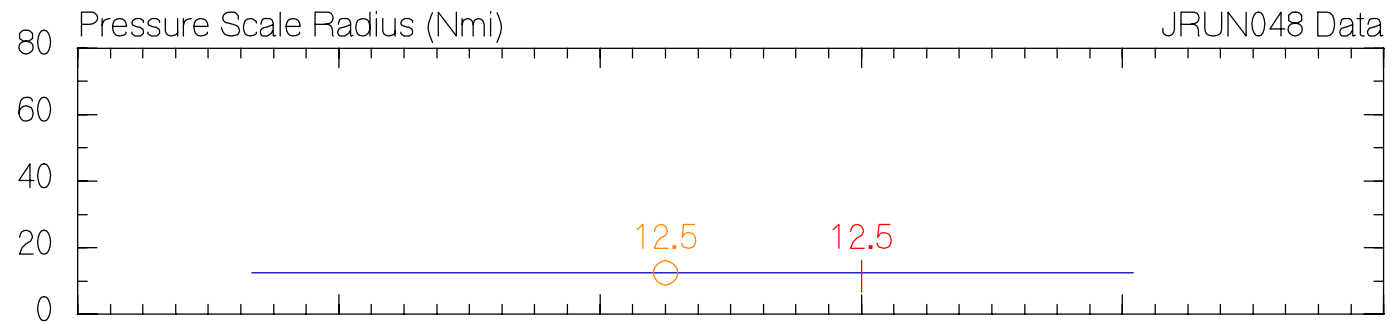
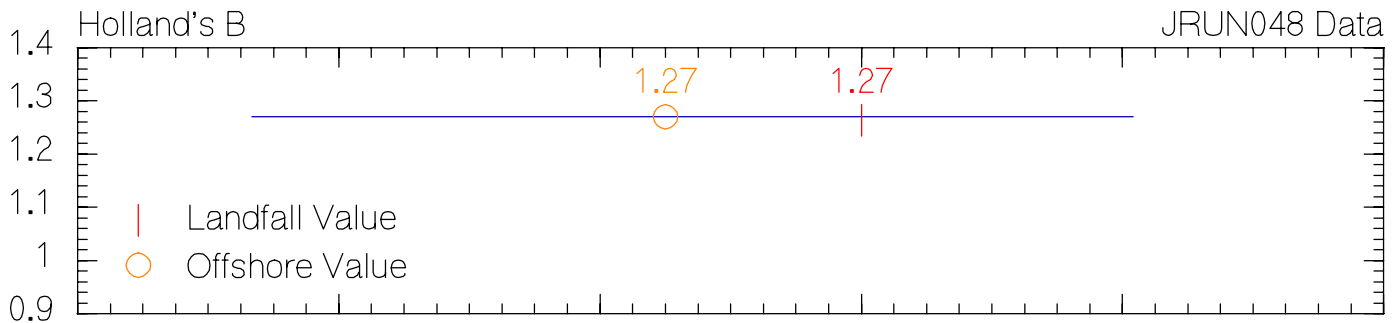
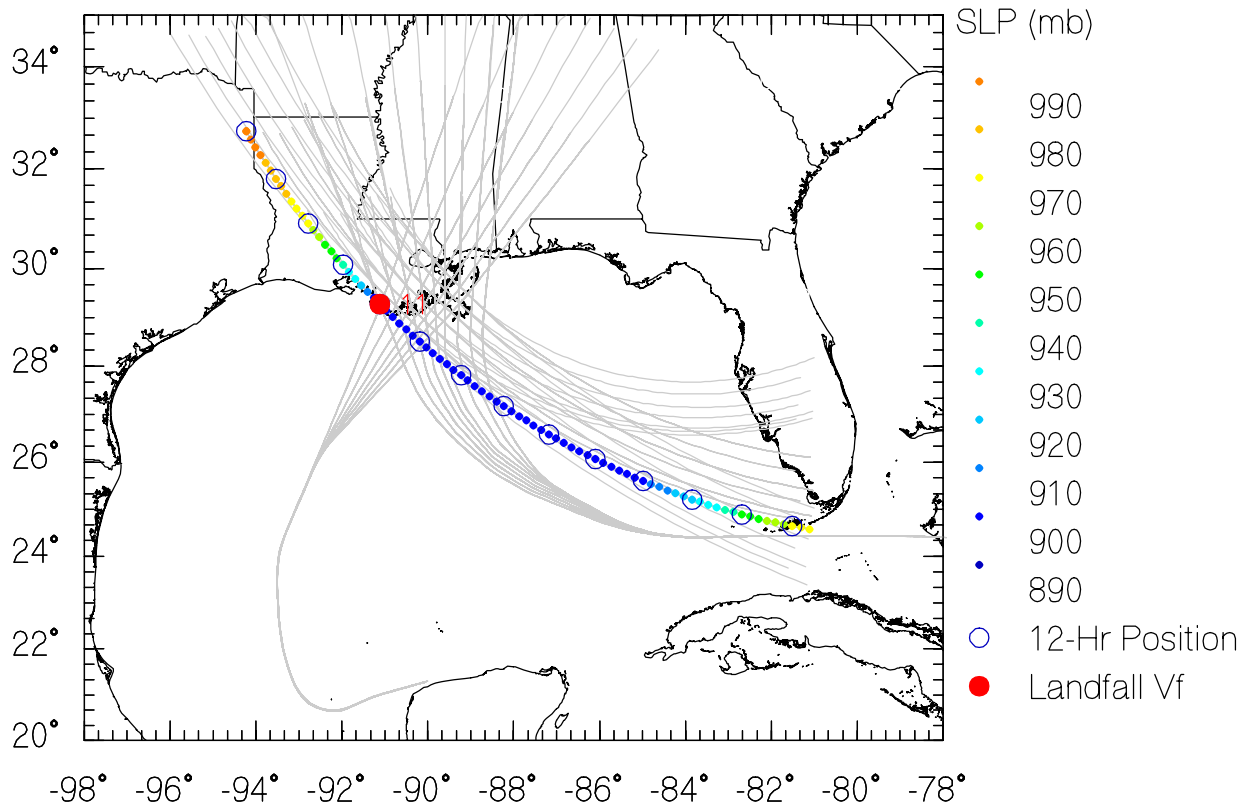

JRUN049 Data

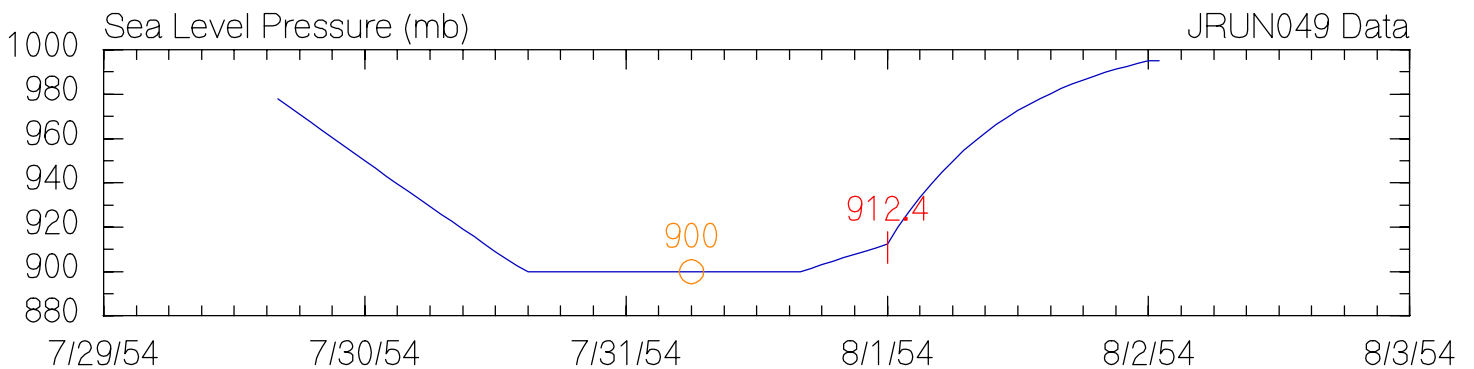
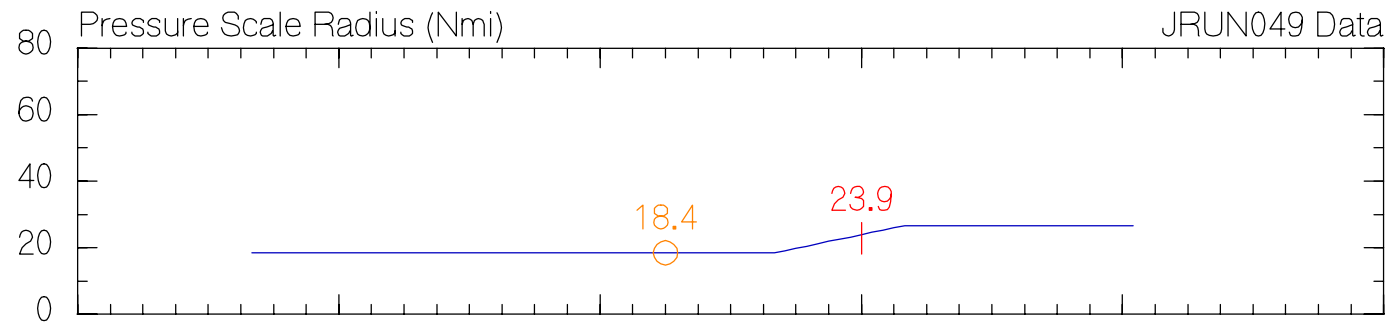
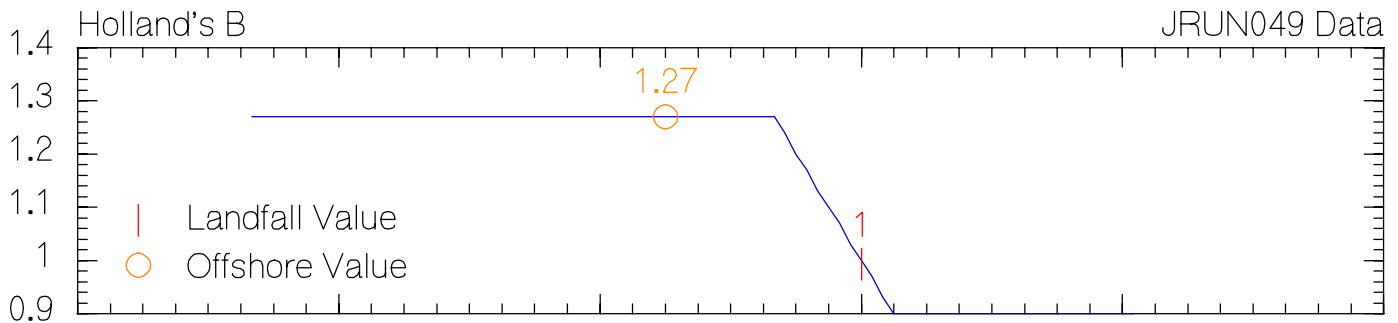
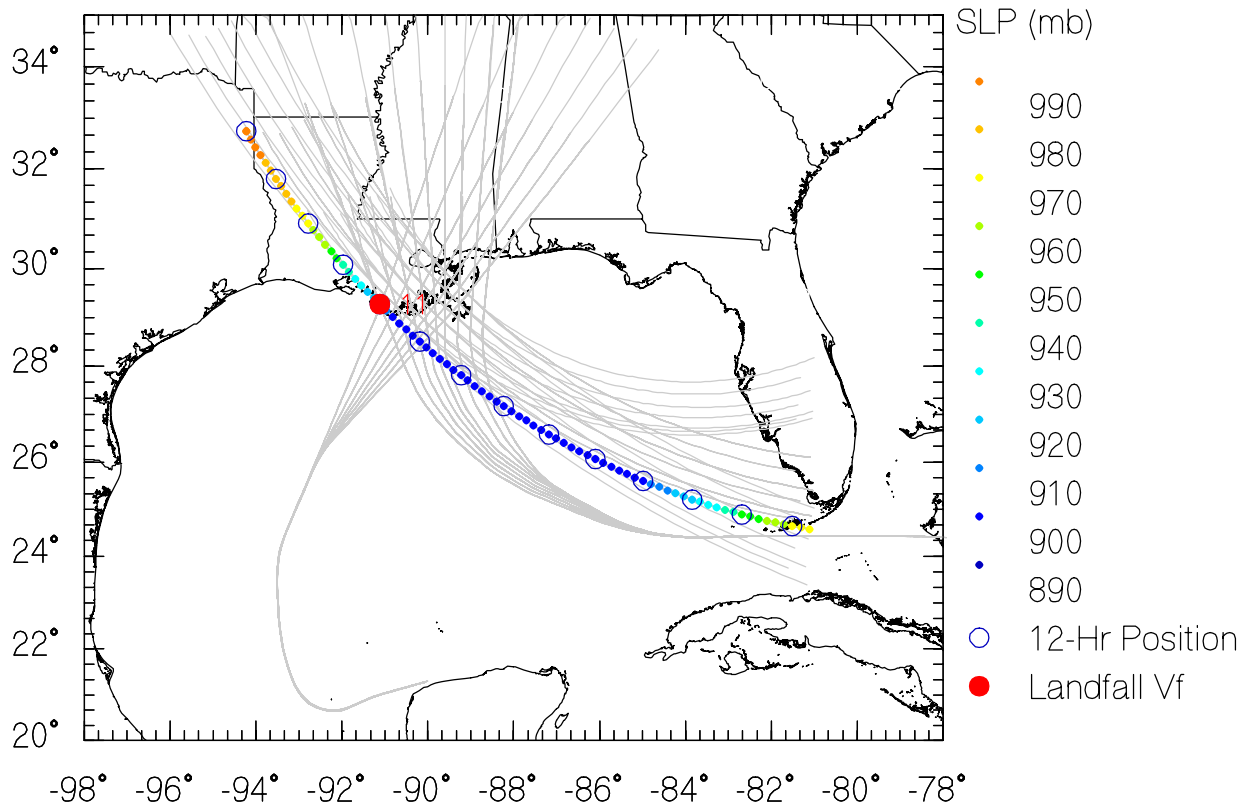

JRUN050 Data

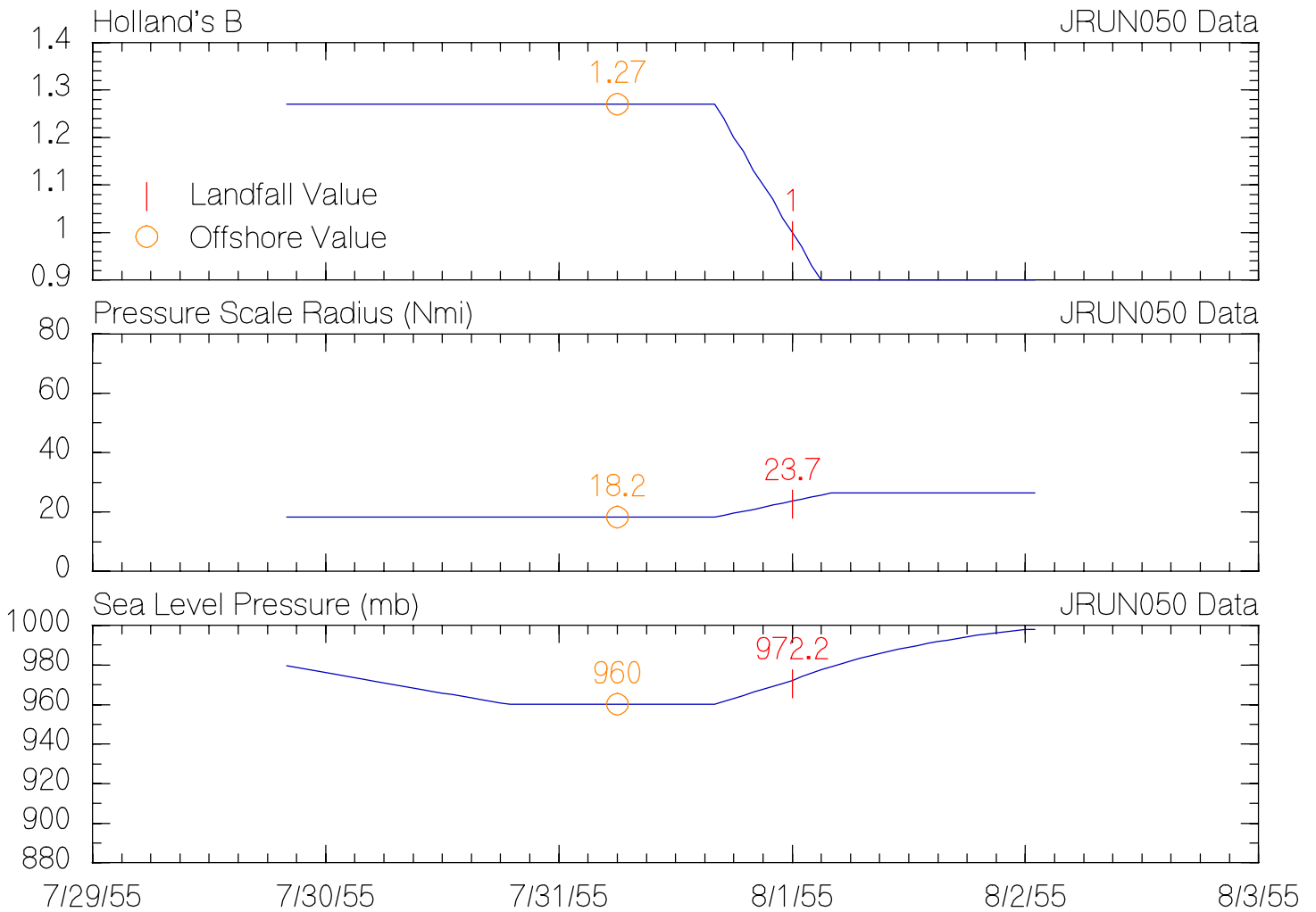
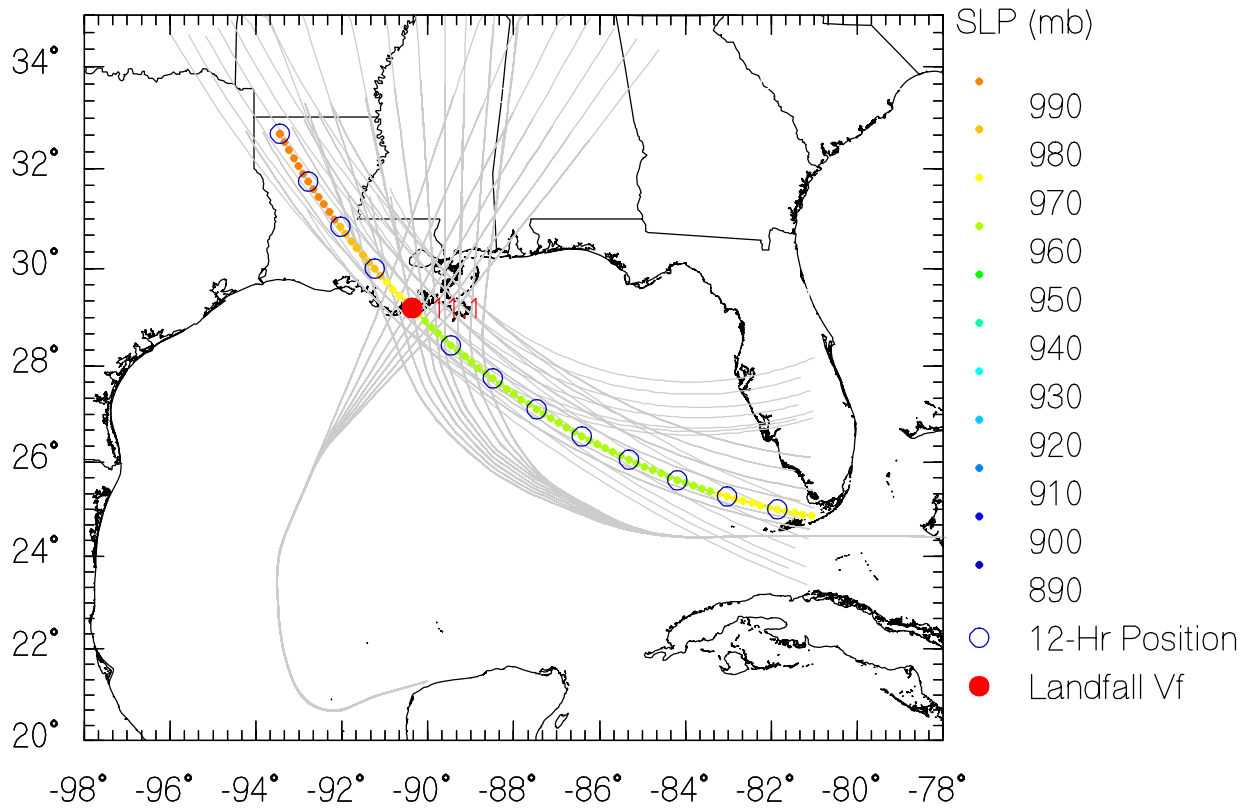

JRUN051 Data

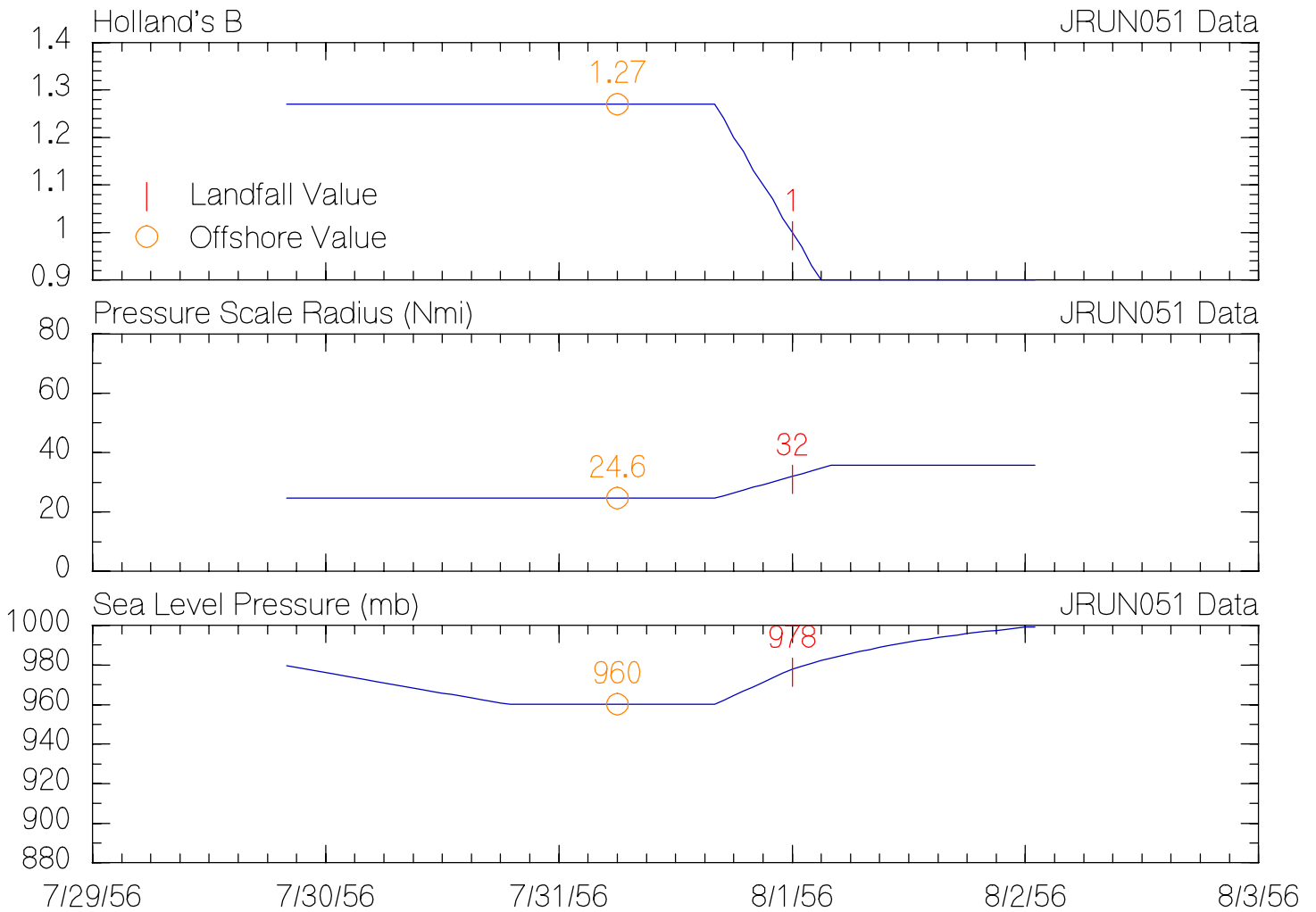
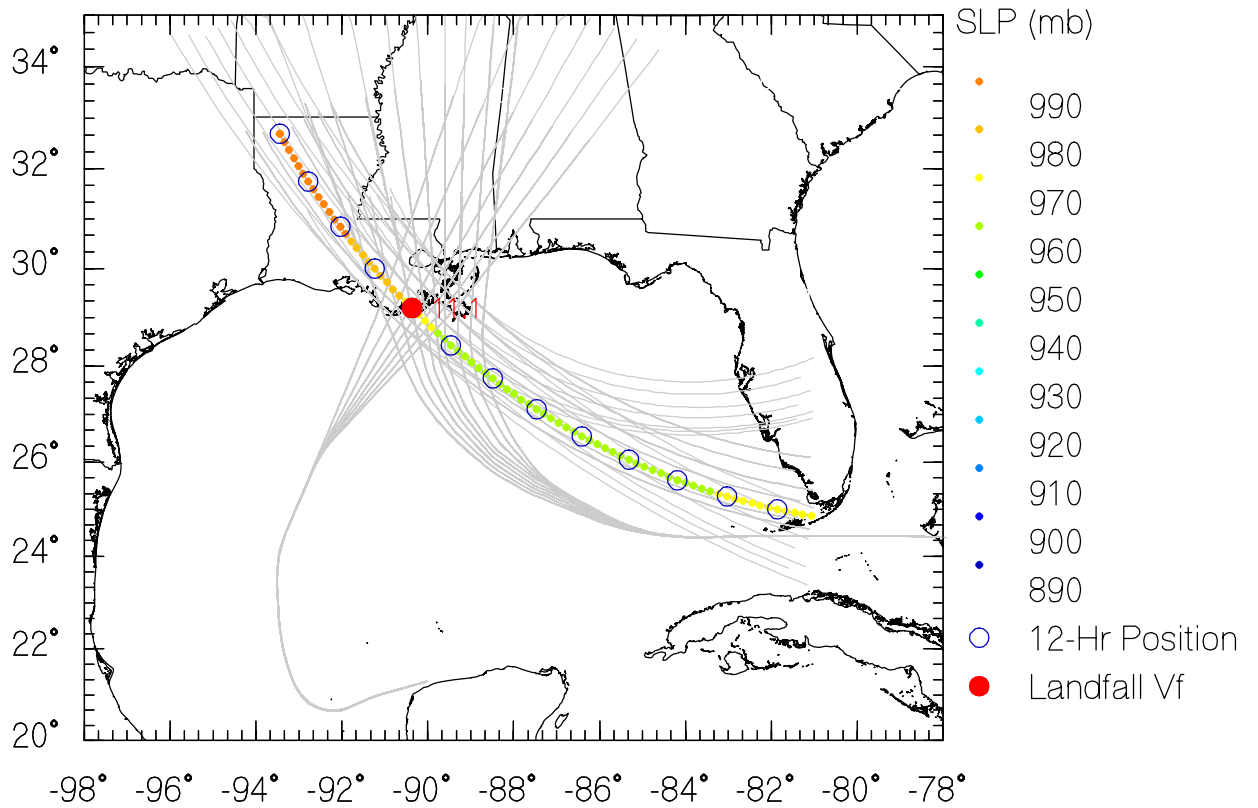

JRUN052 Data

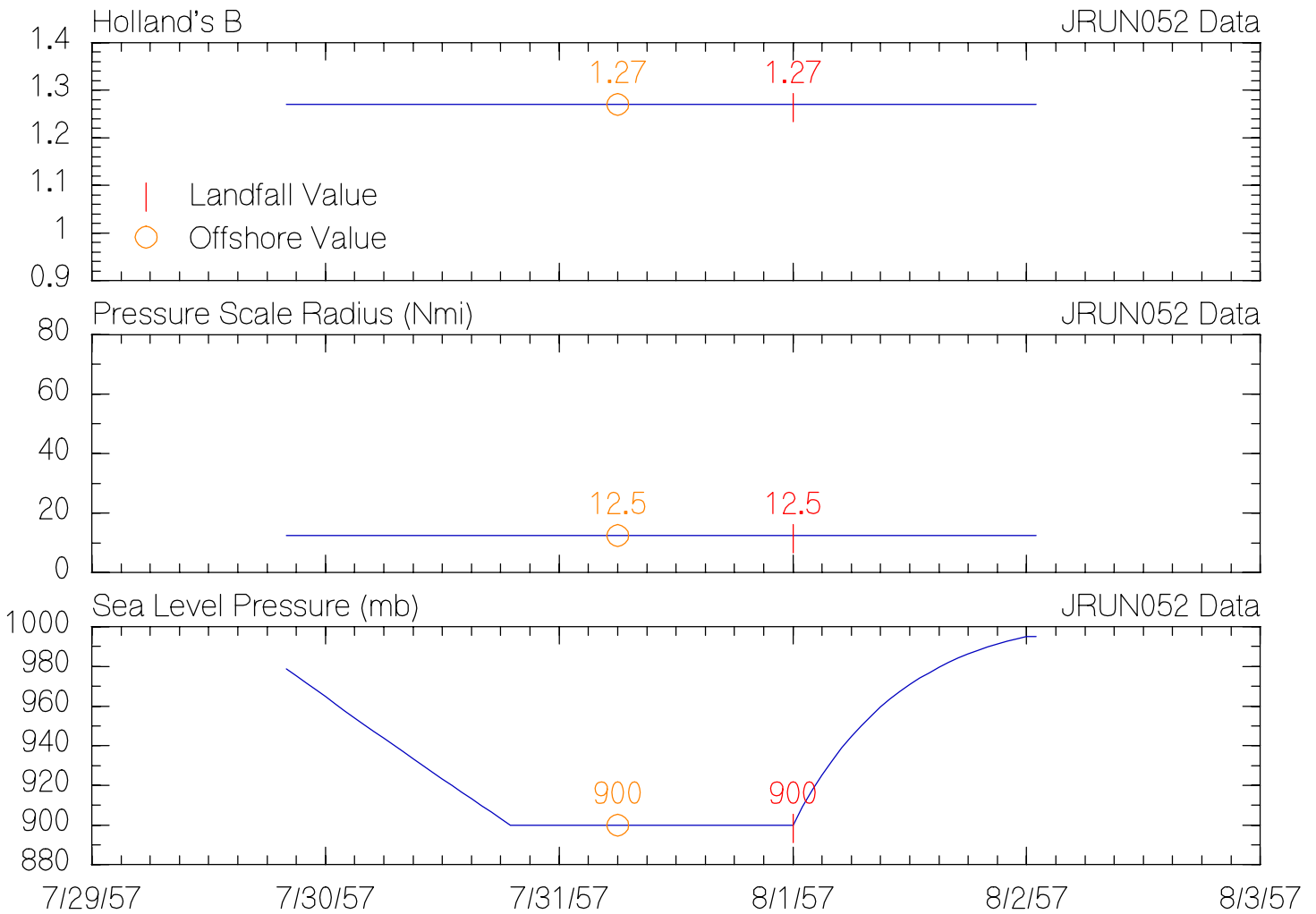
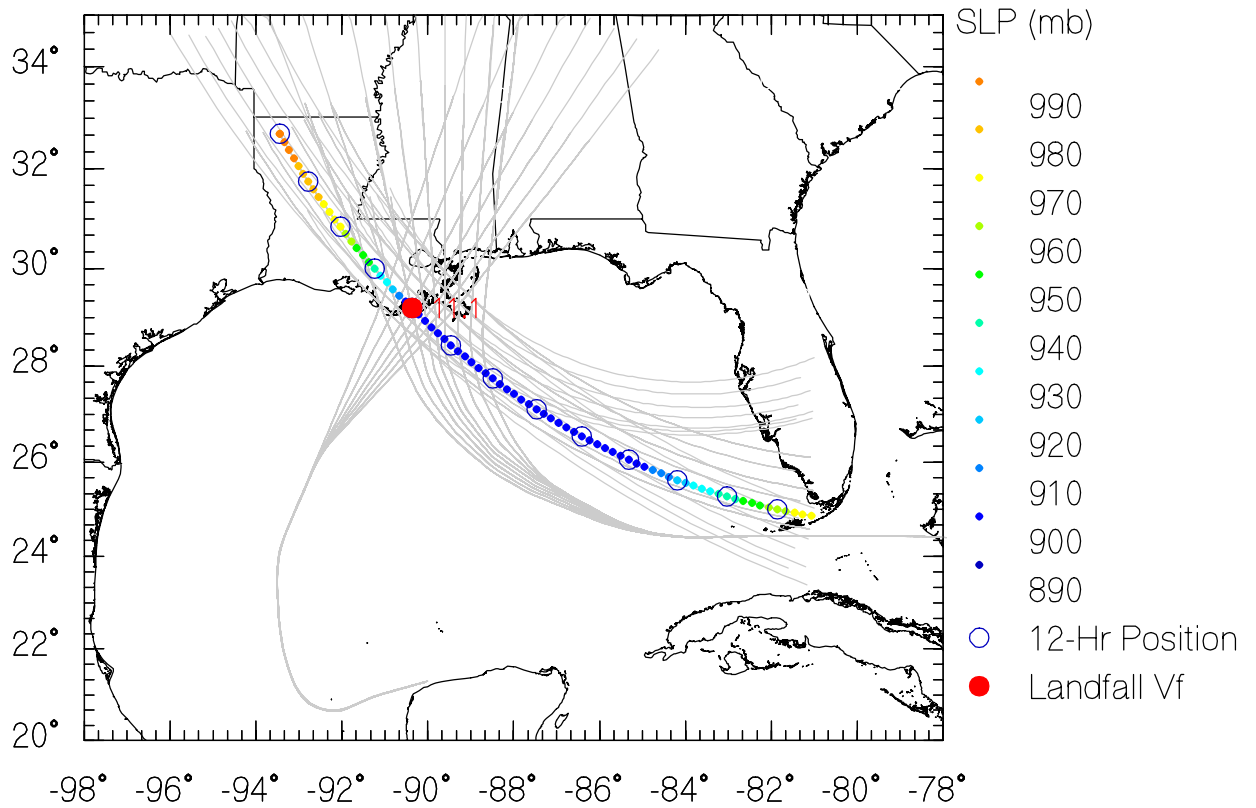

JRUN053 Data

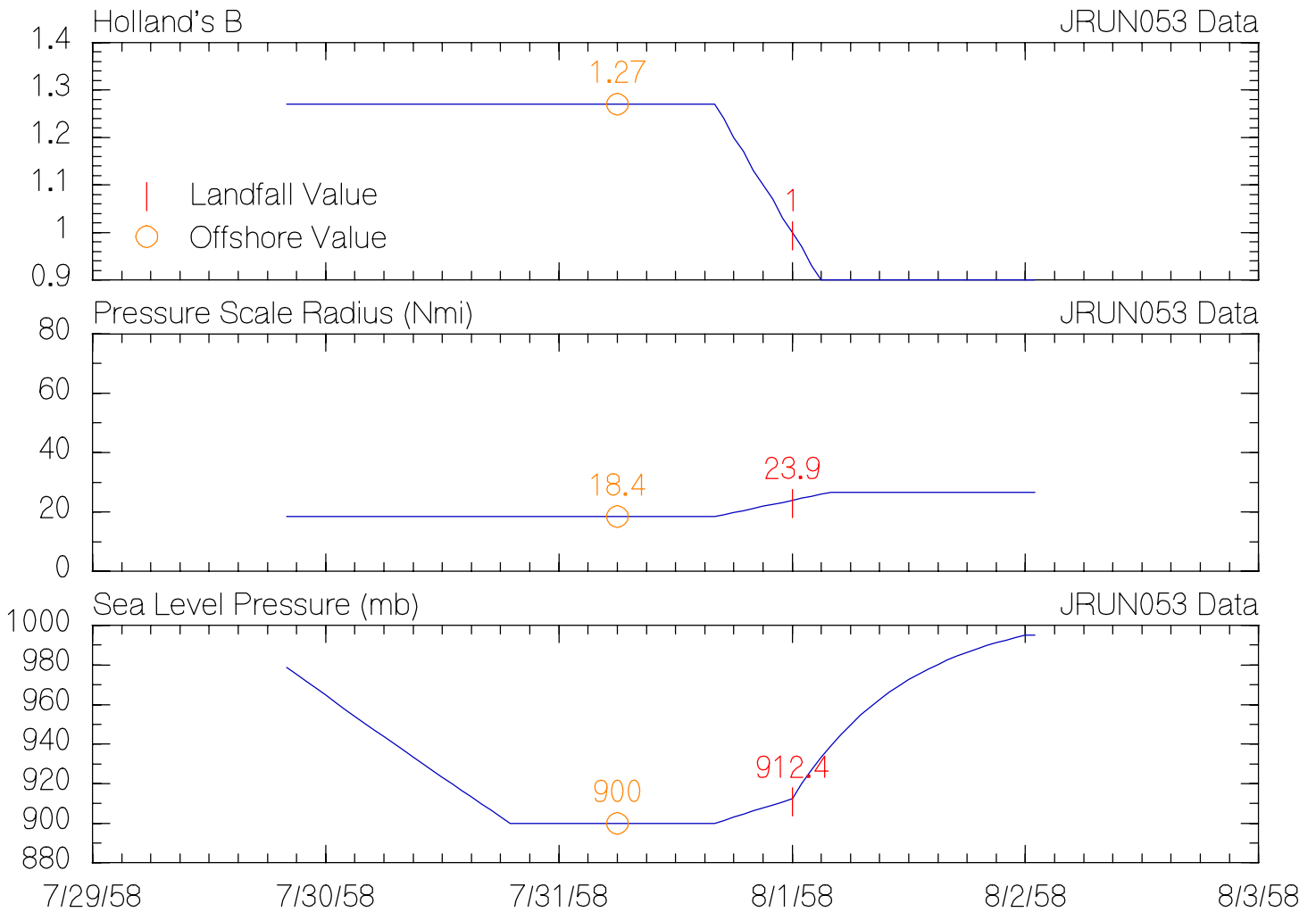
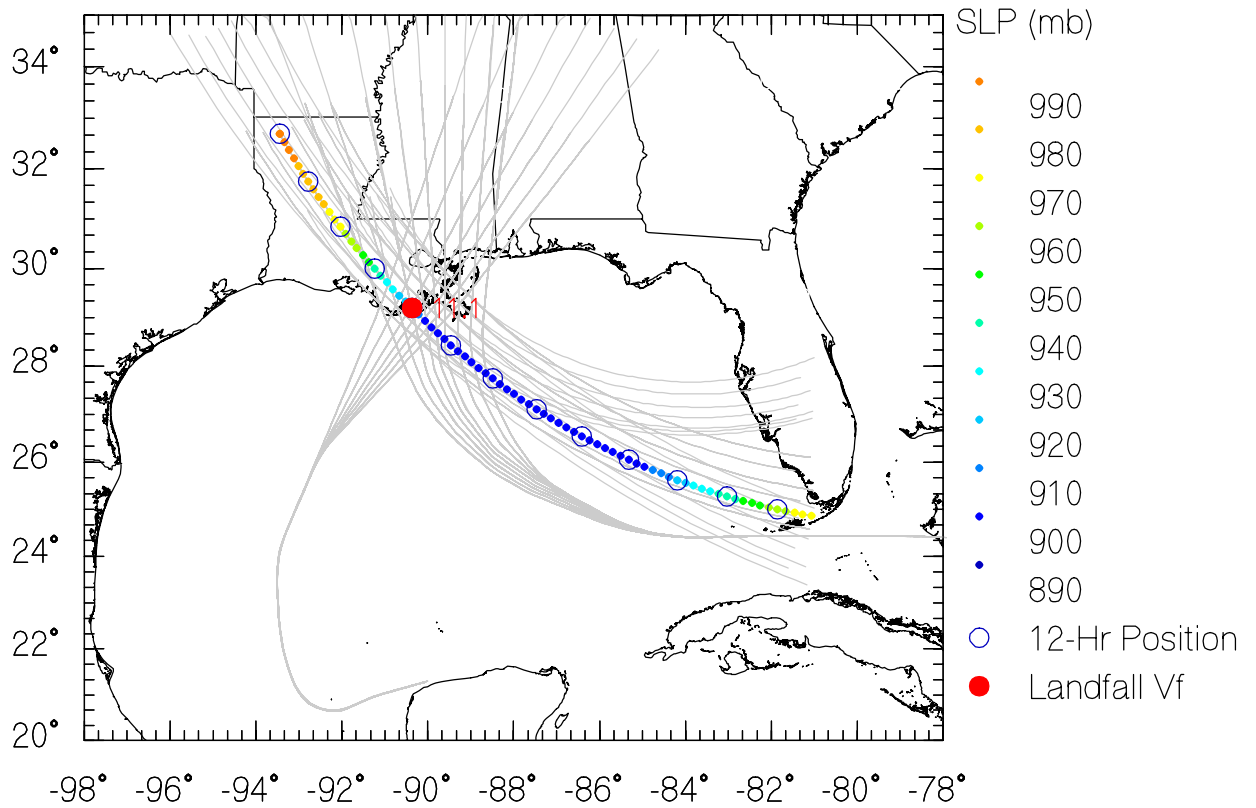

JRUN054 Data

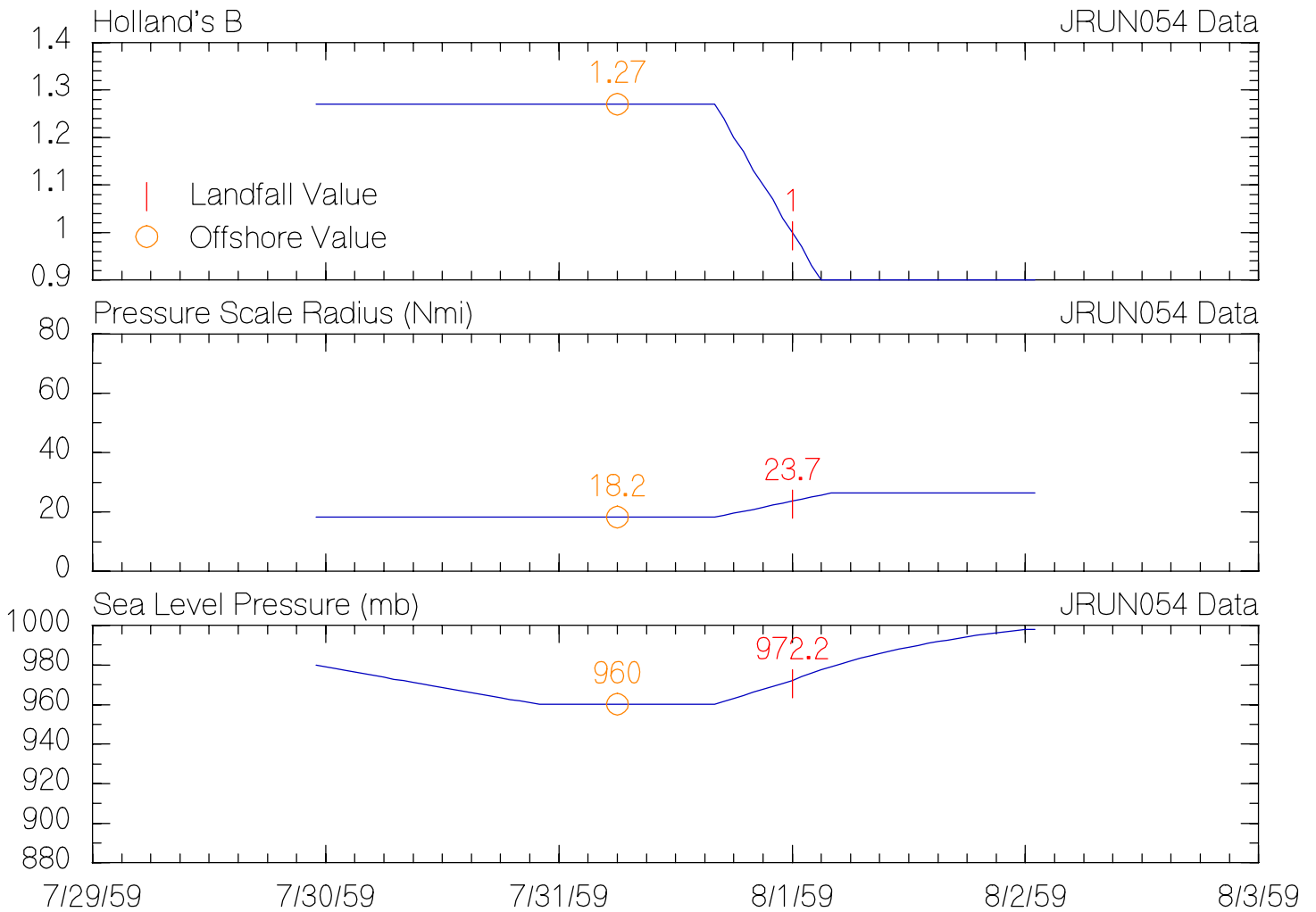
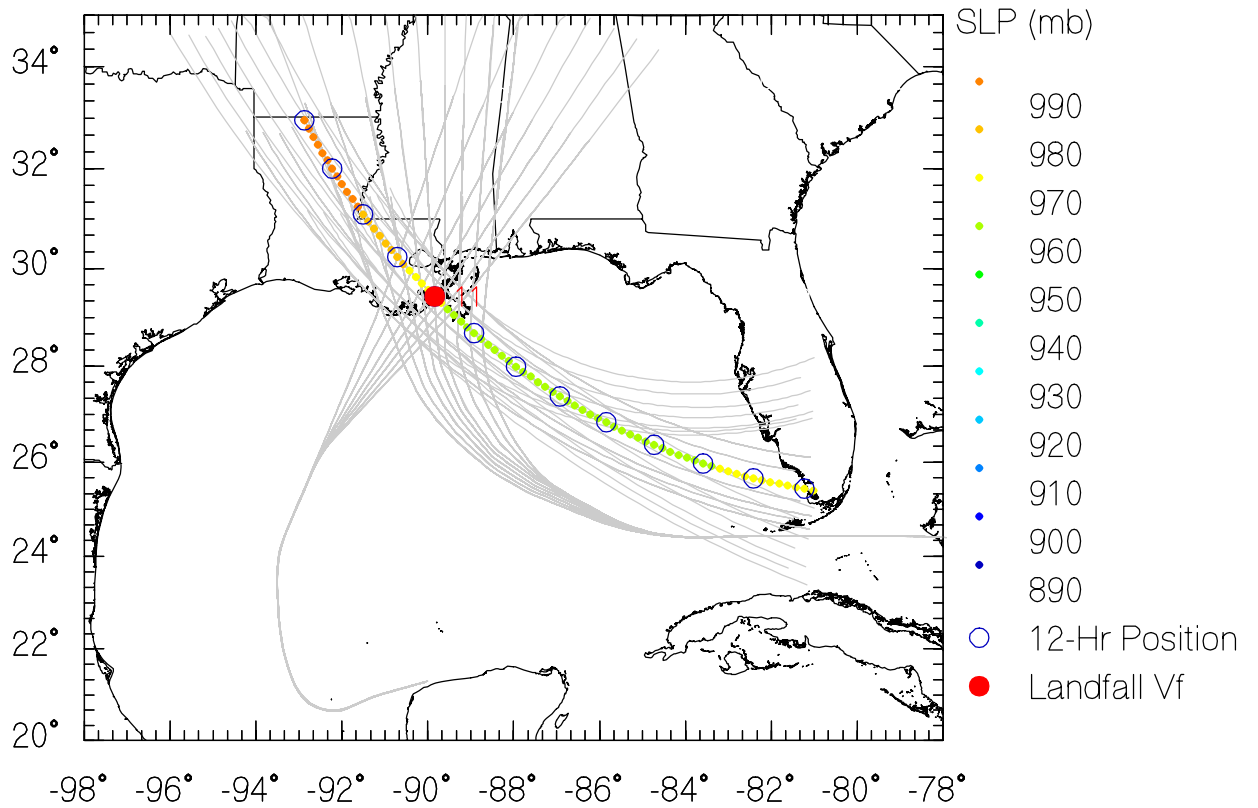

JRUN055 Data

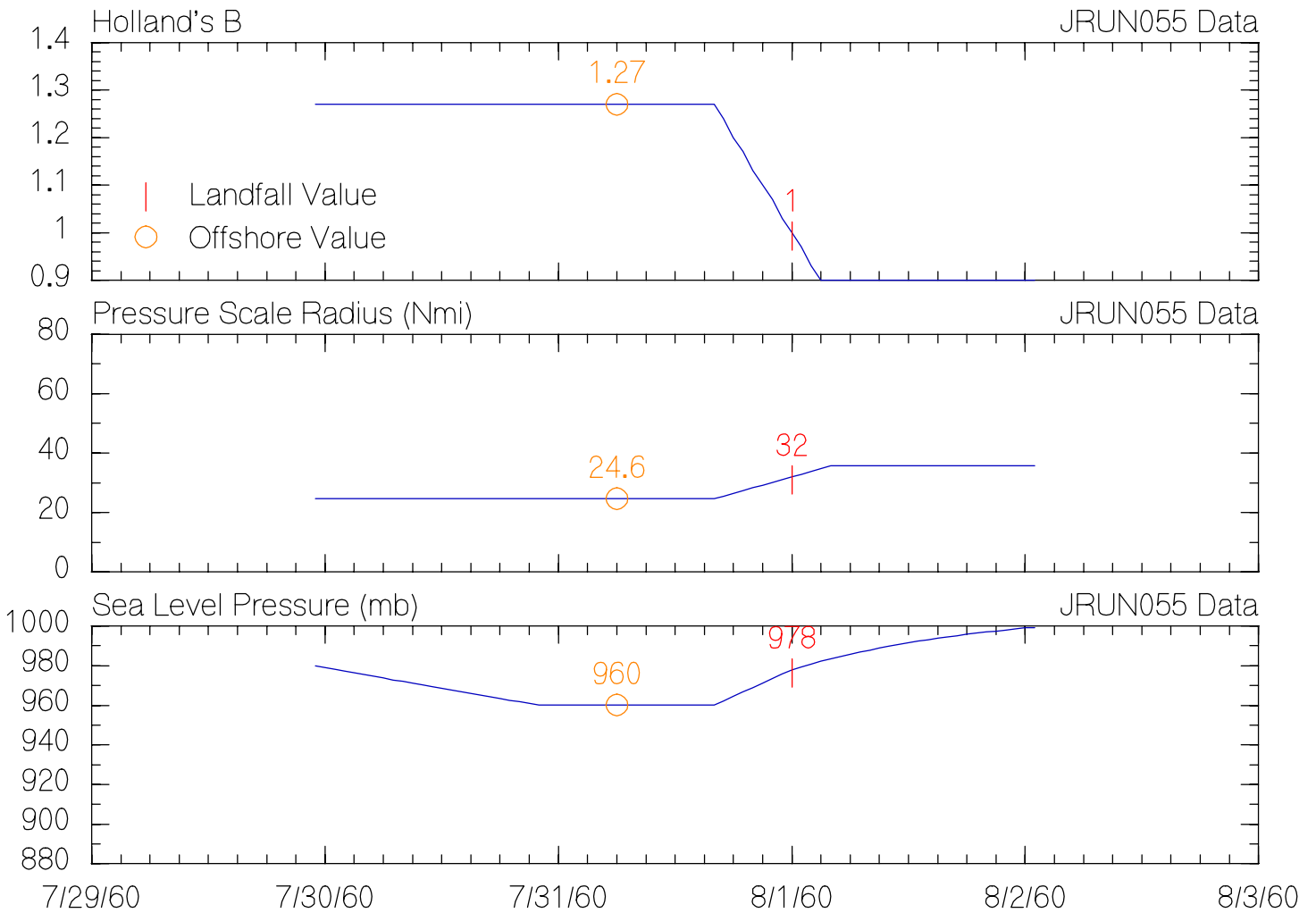
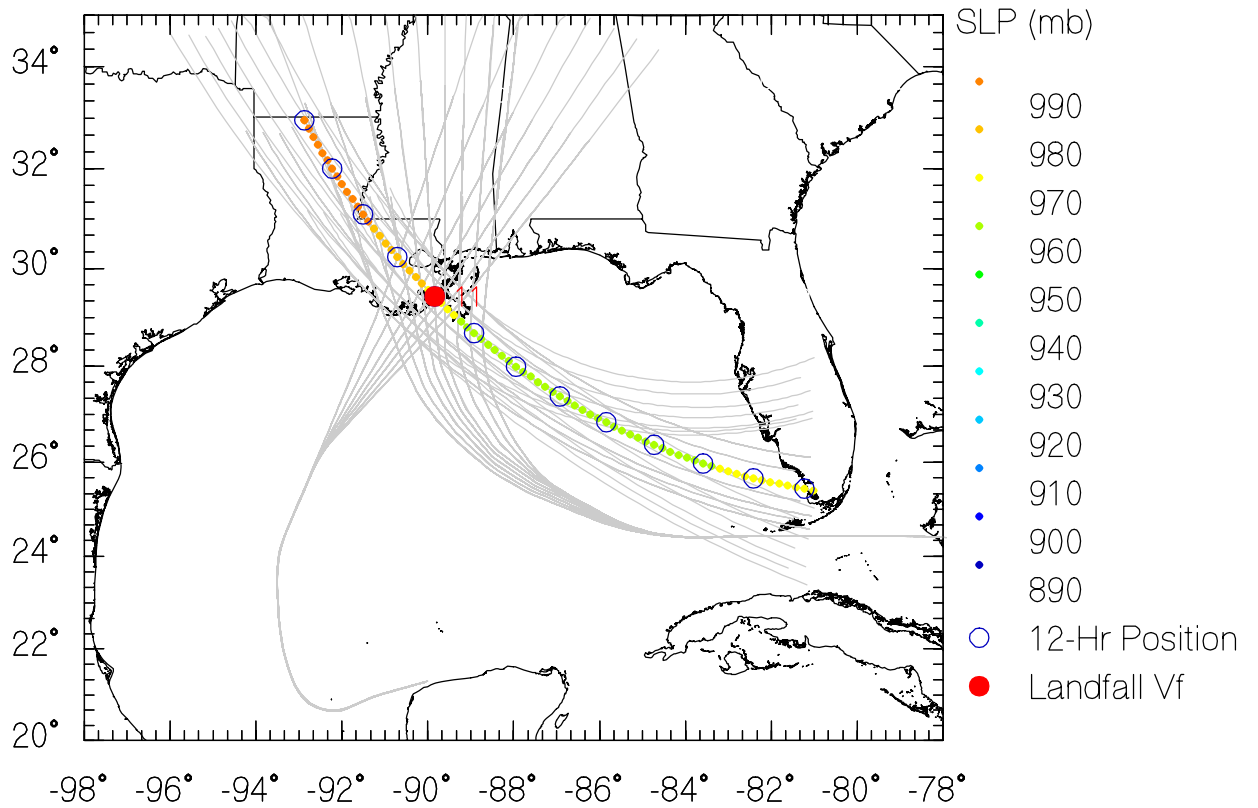

JRUN056 Data

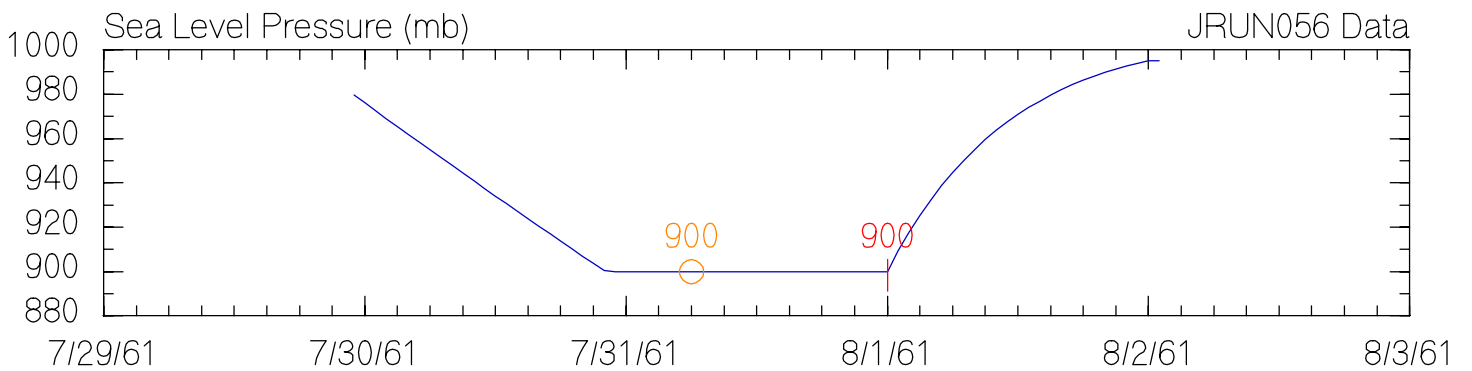
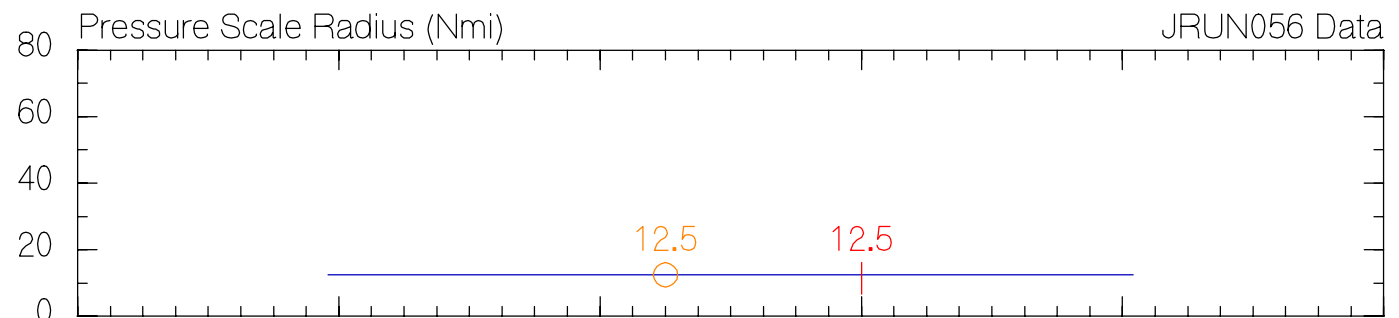
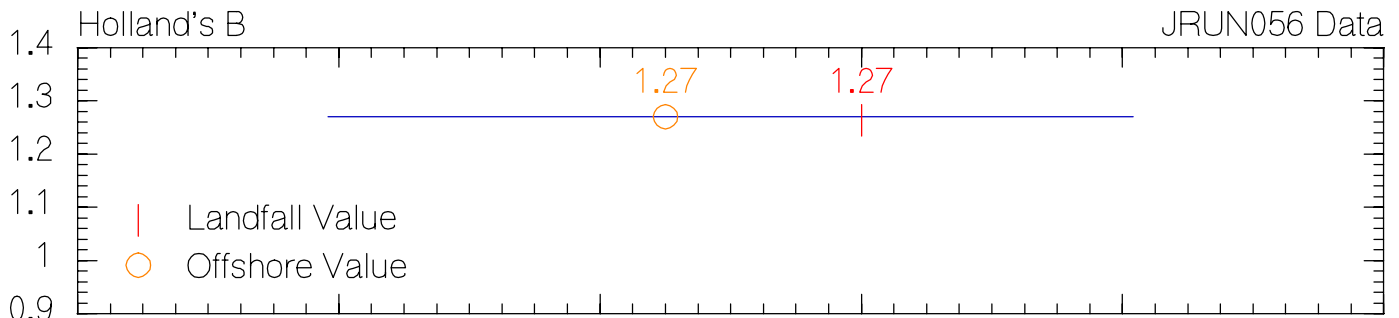
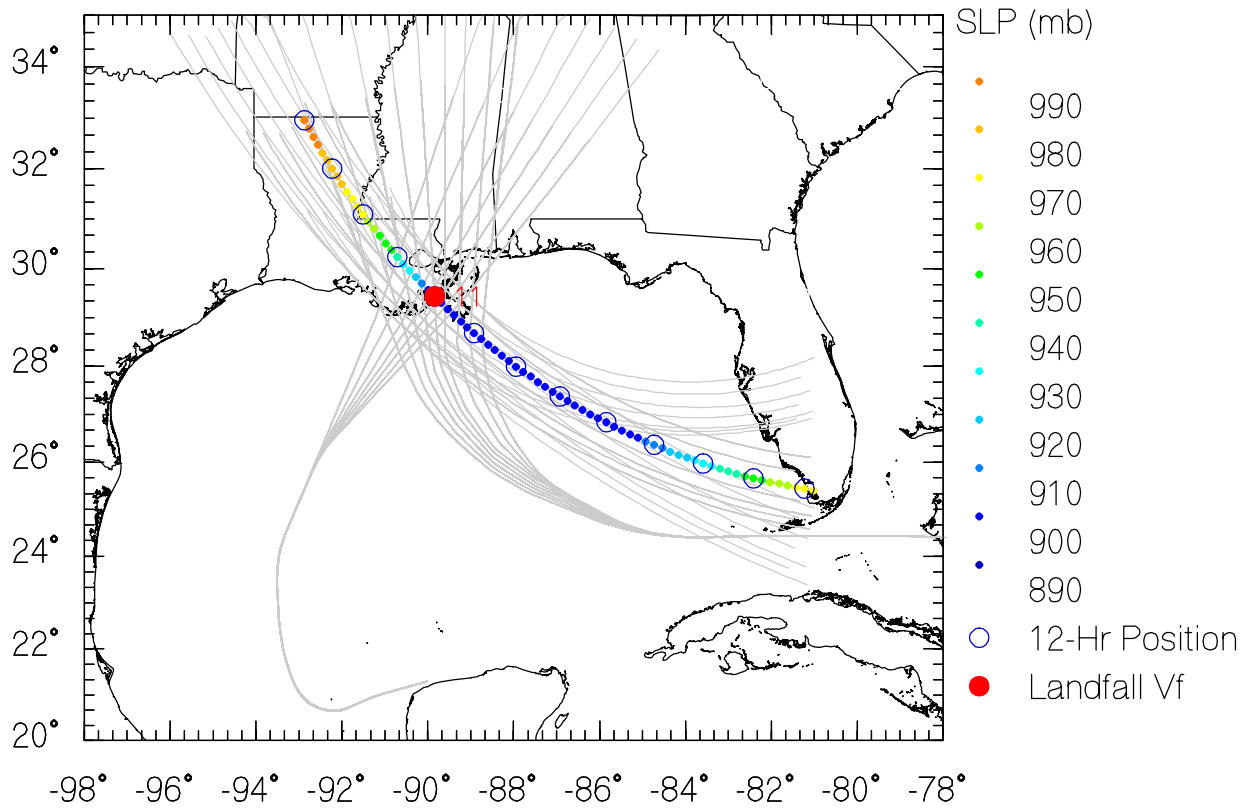

JRUN057 Data

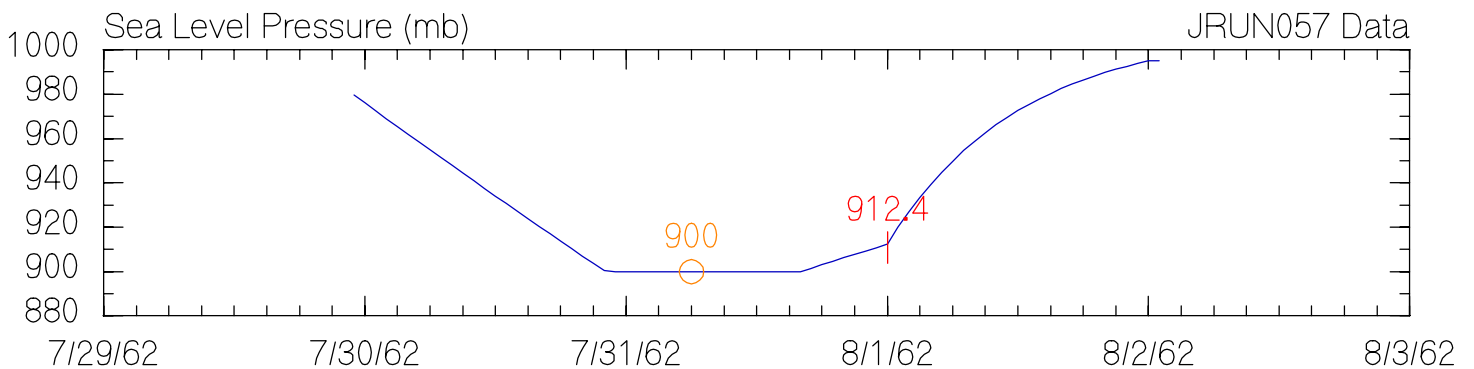
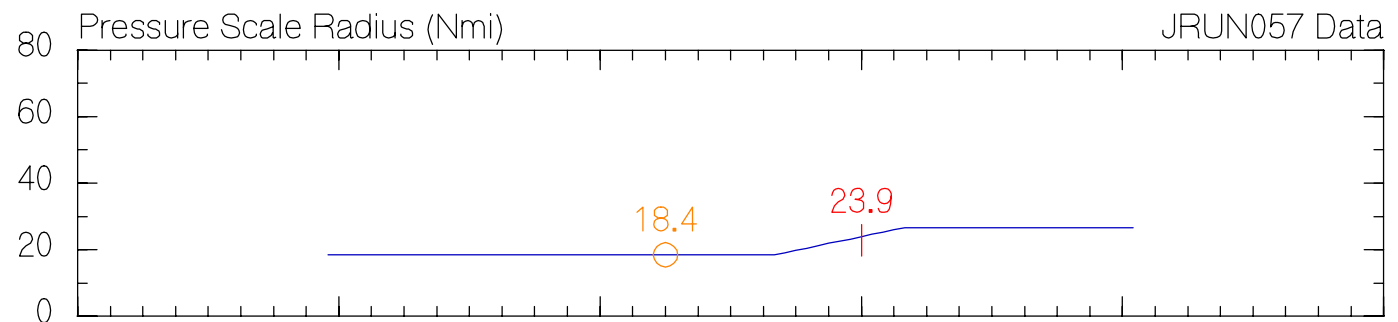
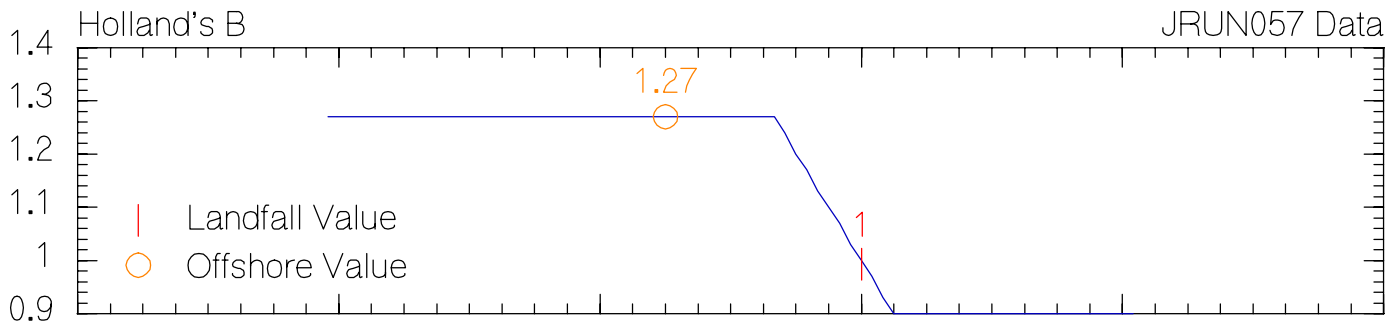
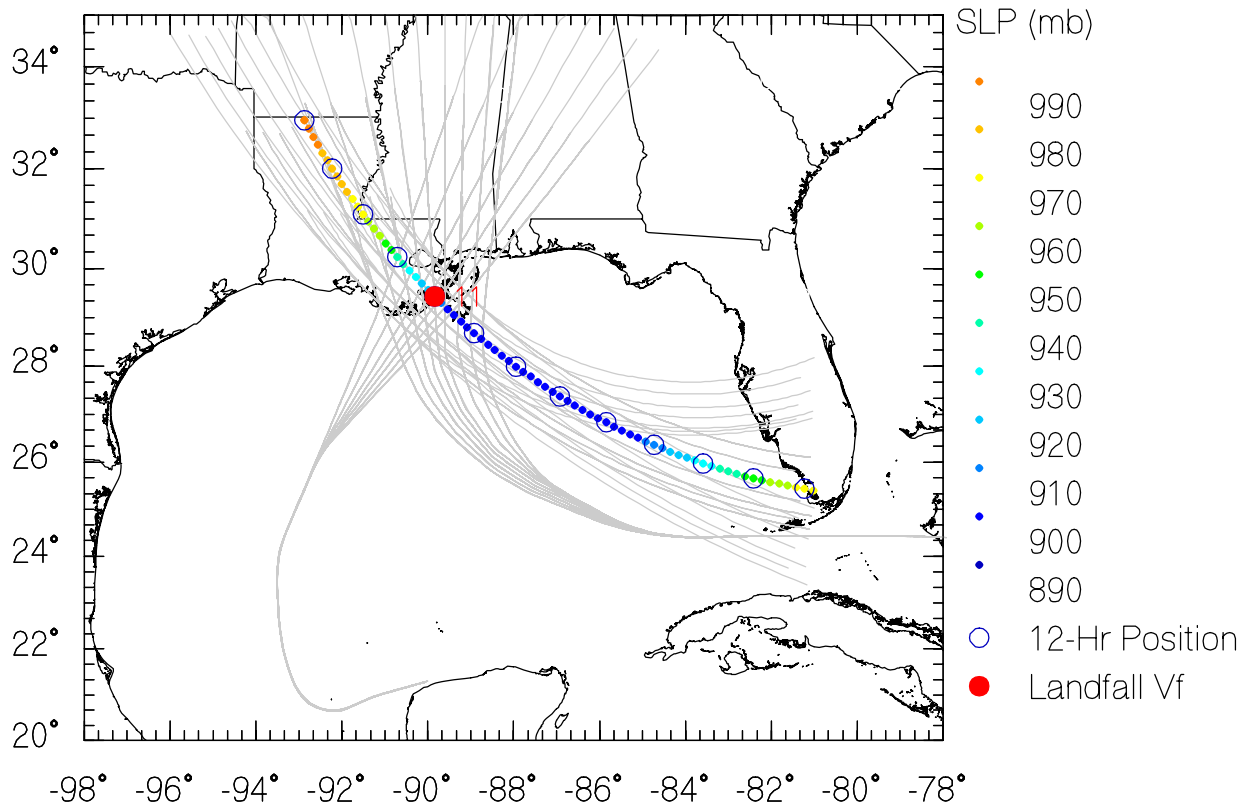

JRUN058 Data

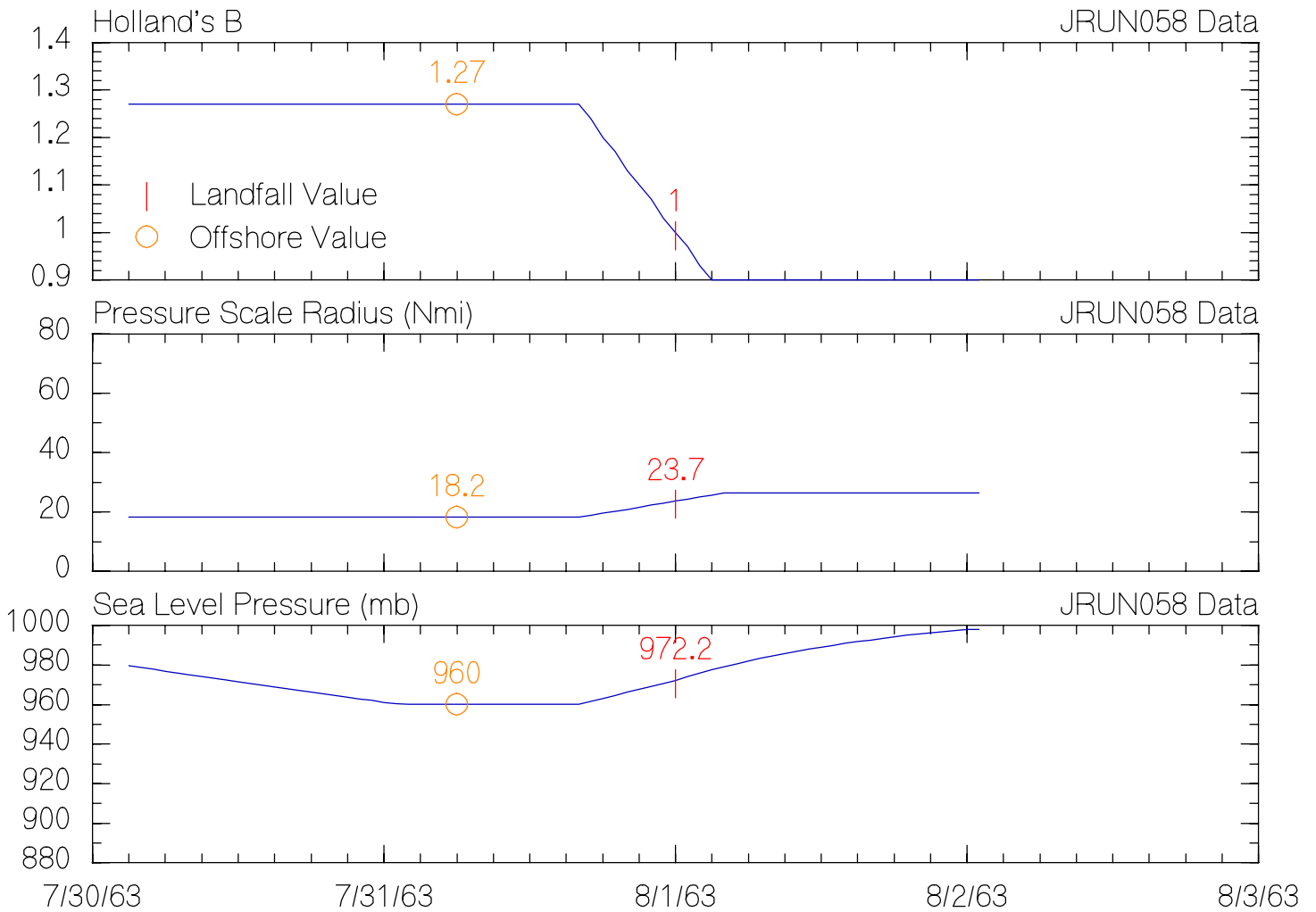
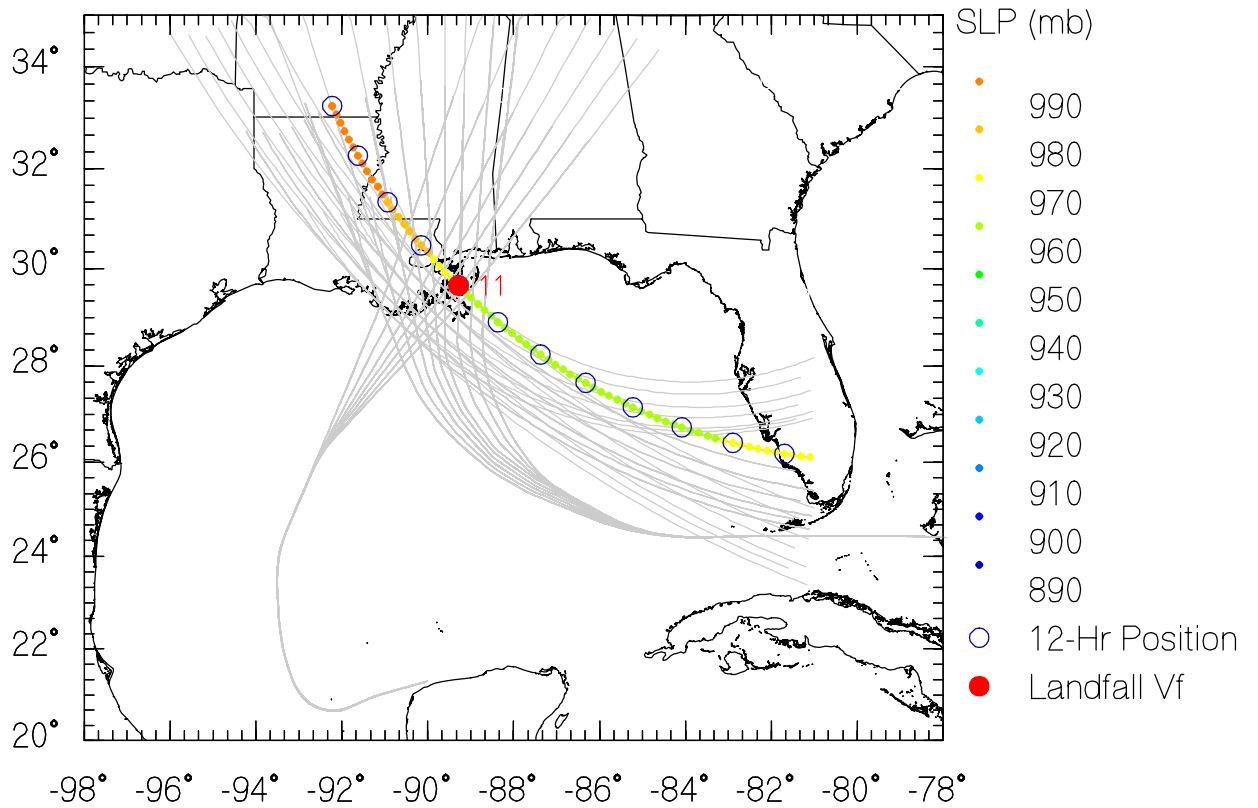

JRUN059 Data

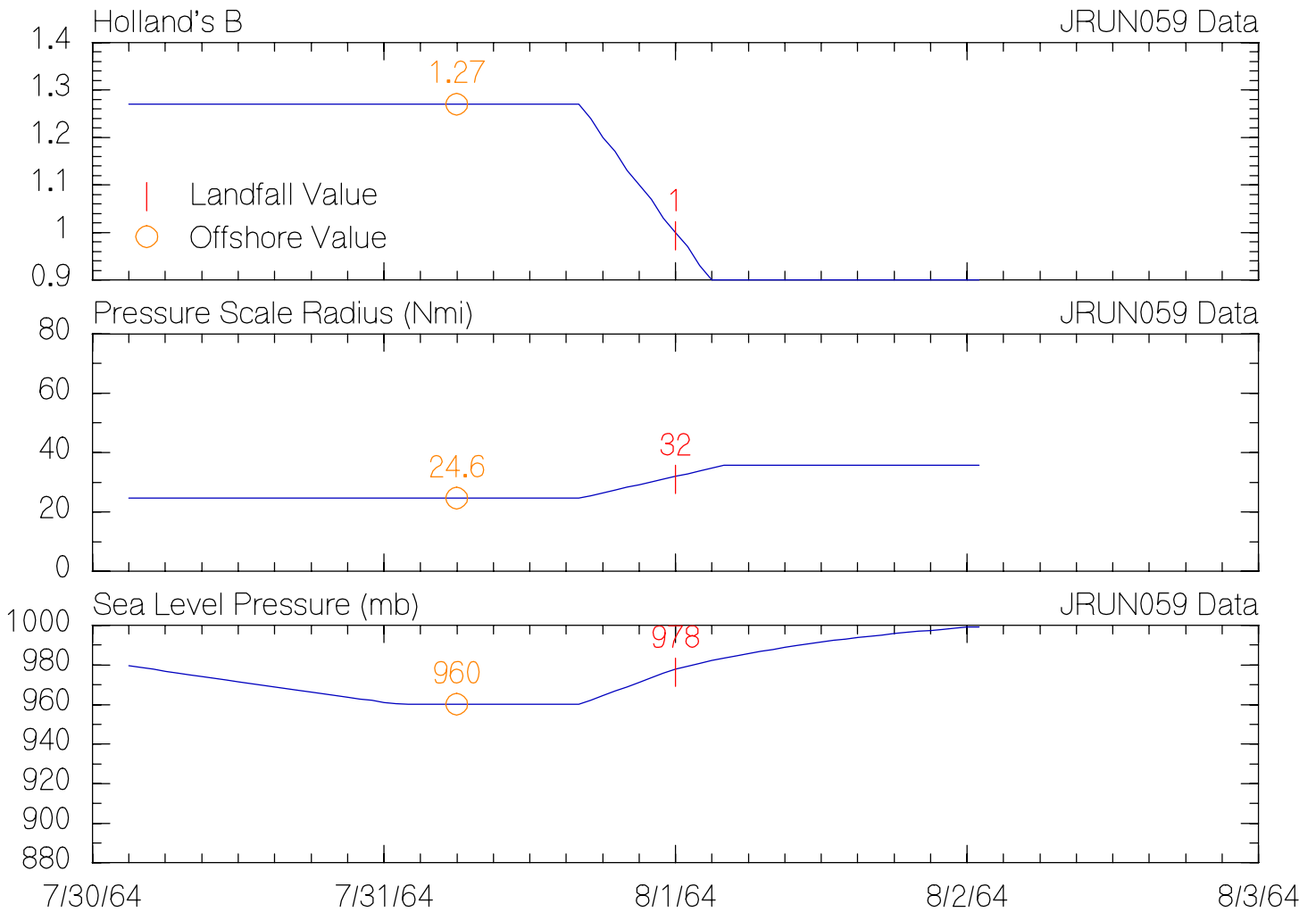
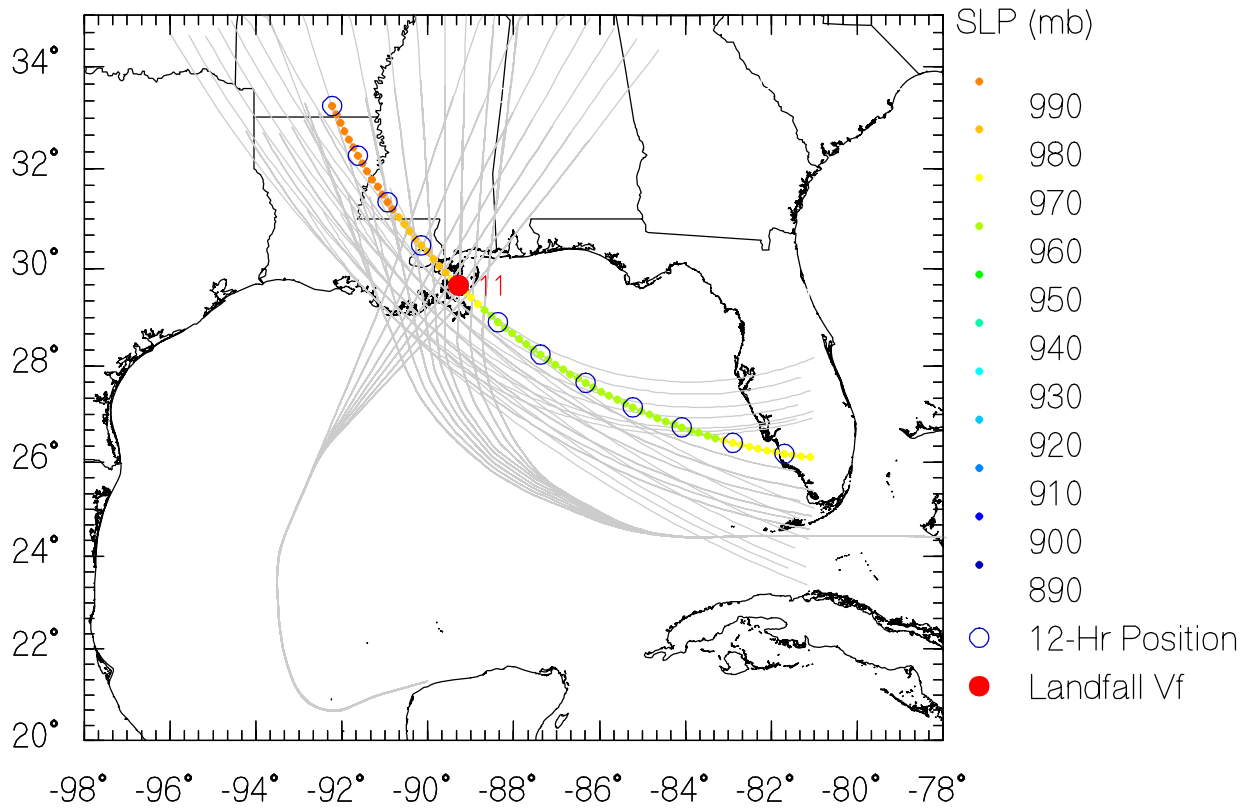

JRUN060 Data

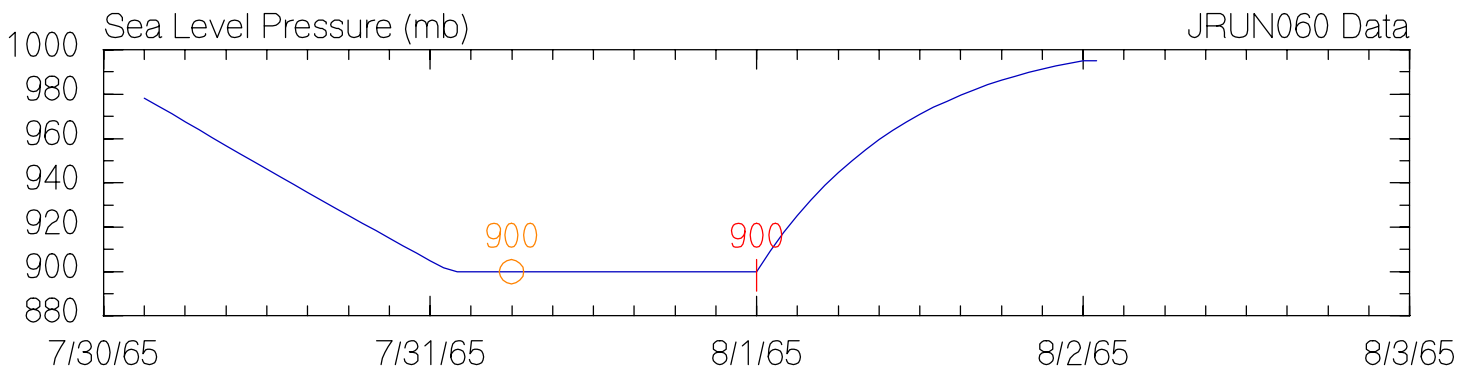
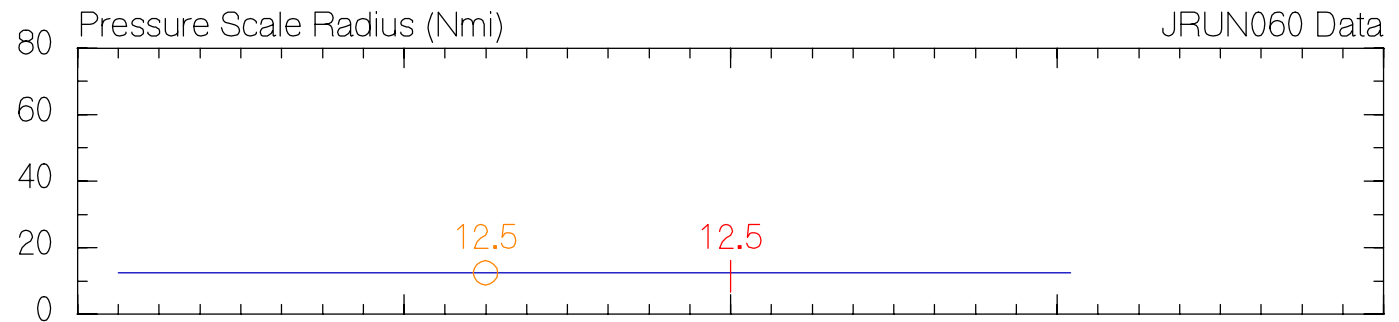
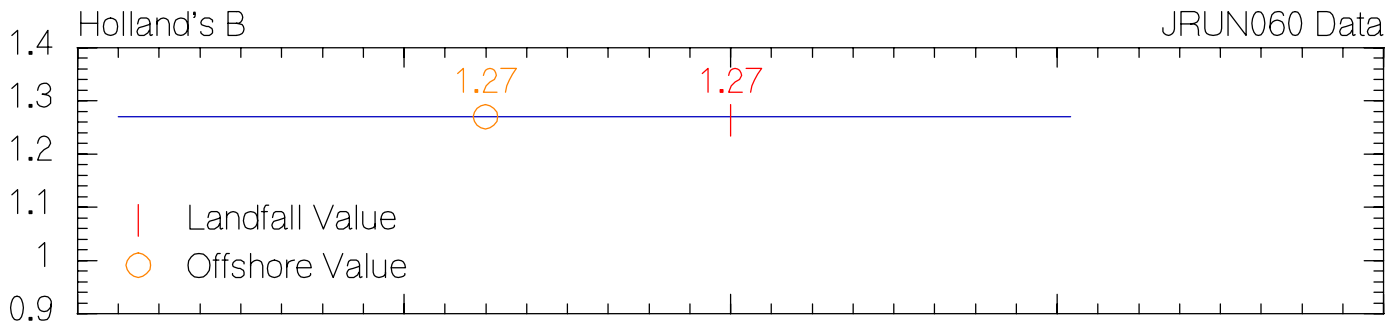
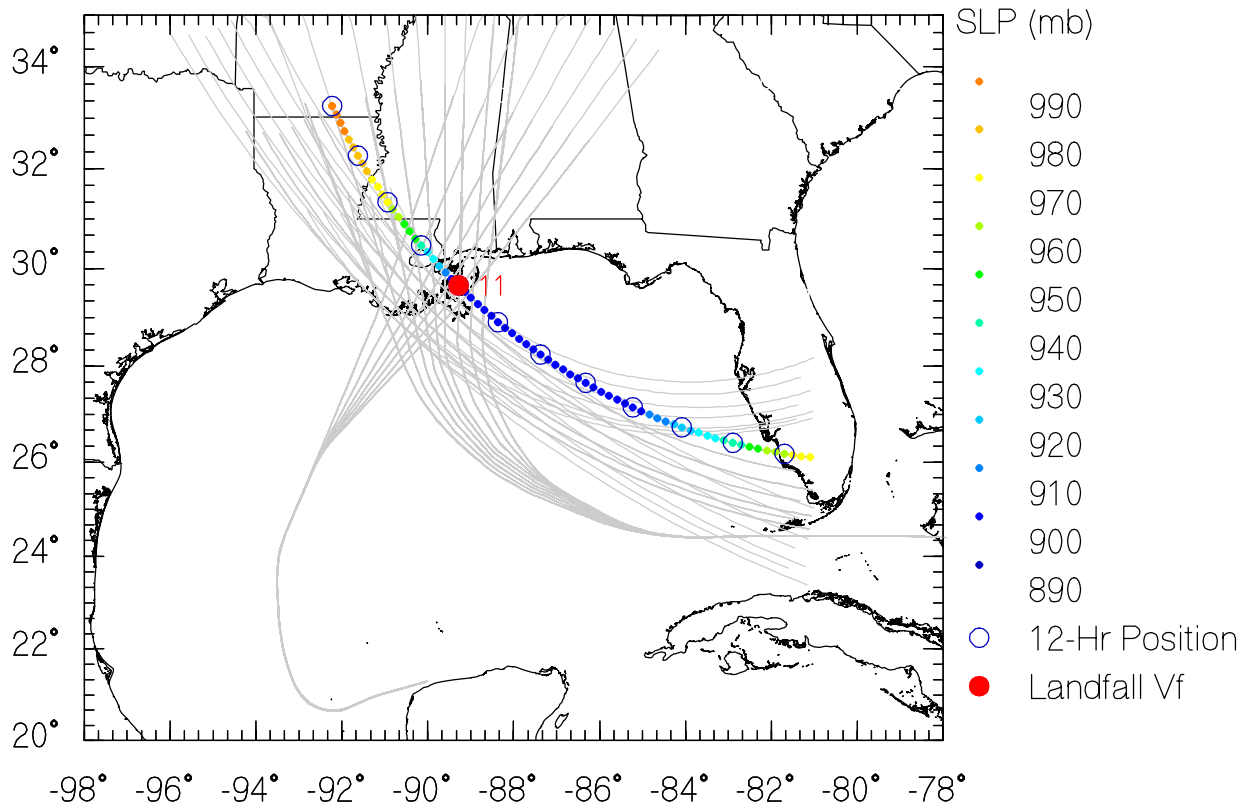

JRUN061 Data

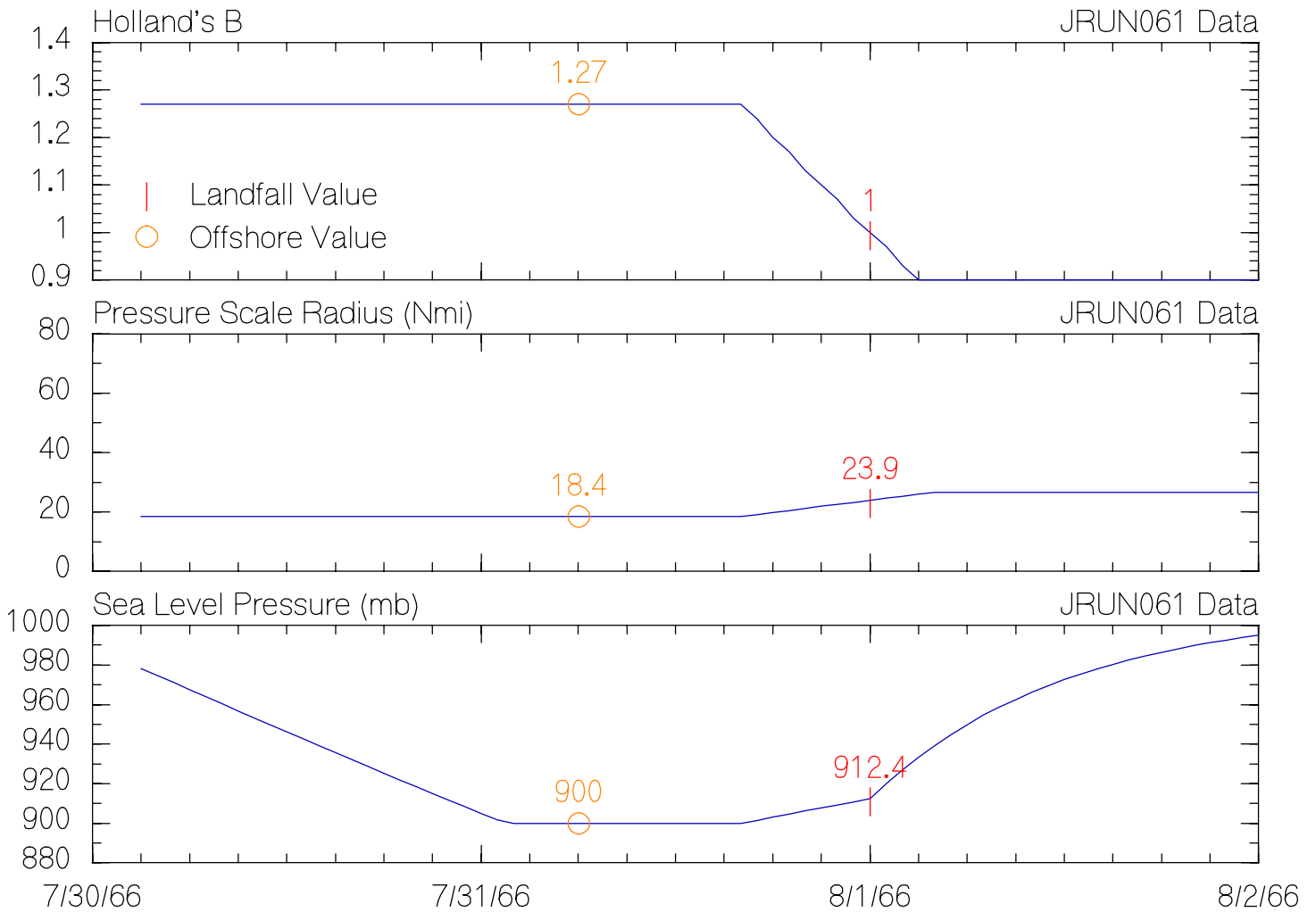
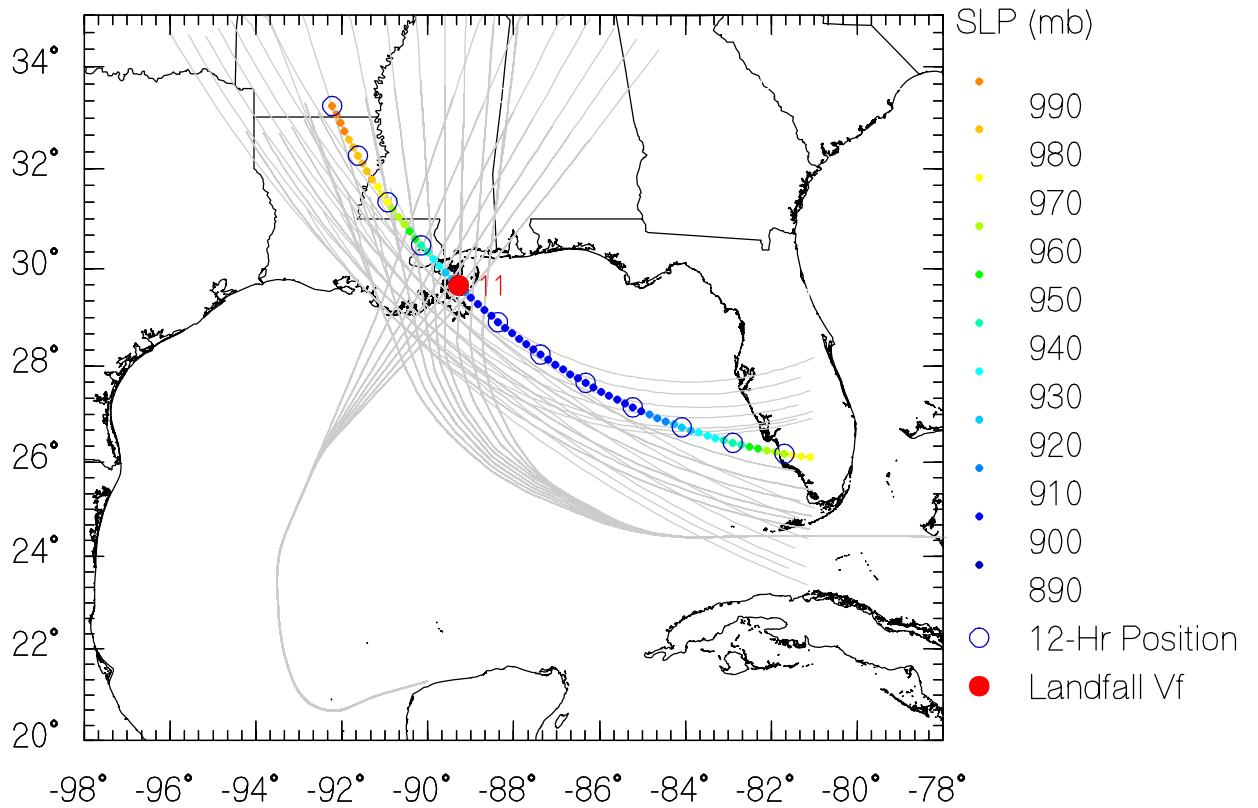

JRUN066 Data

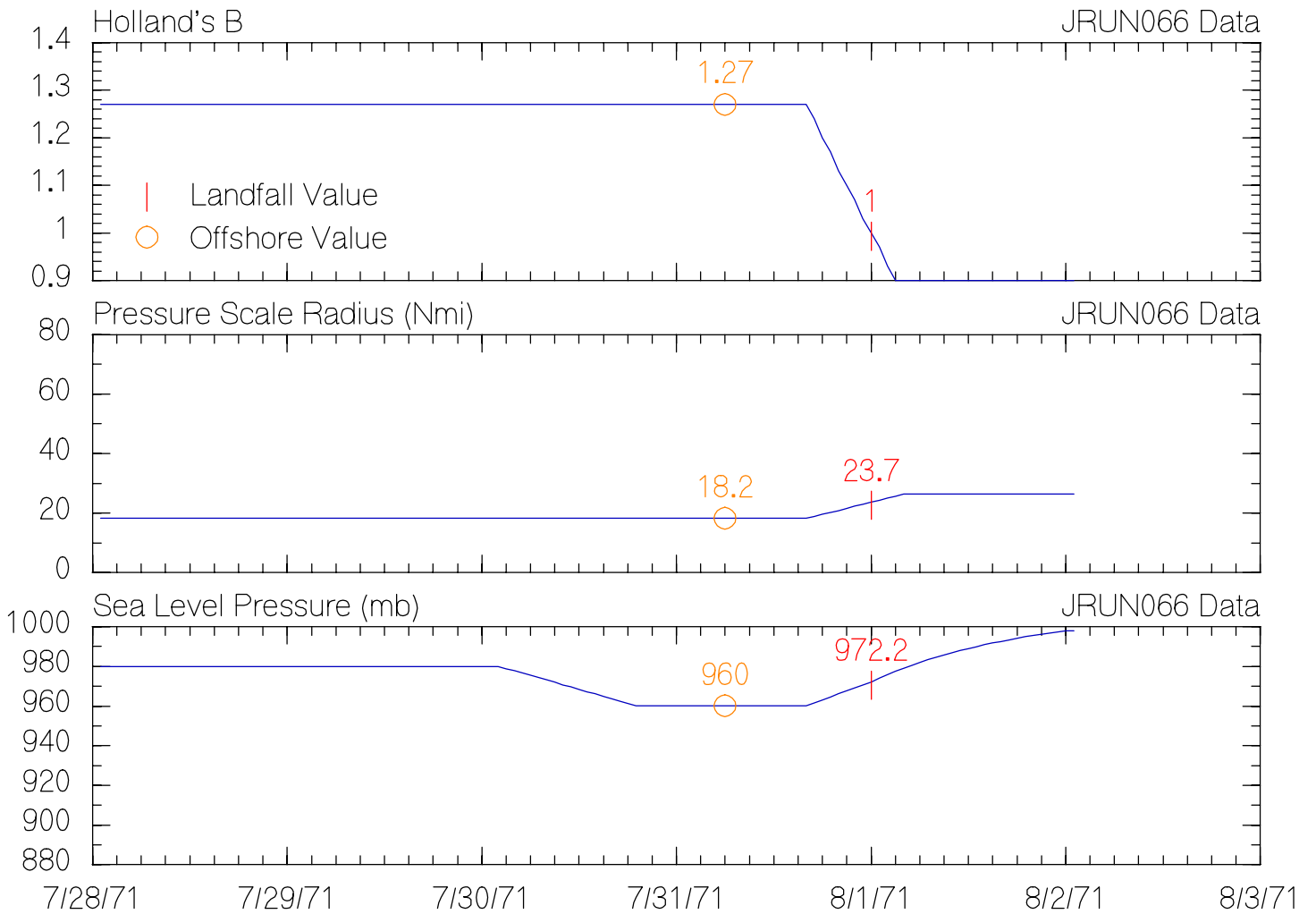
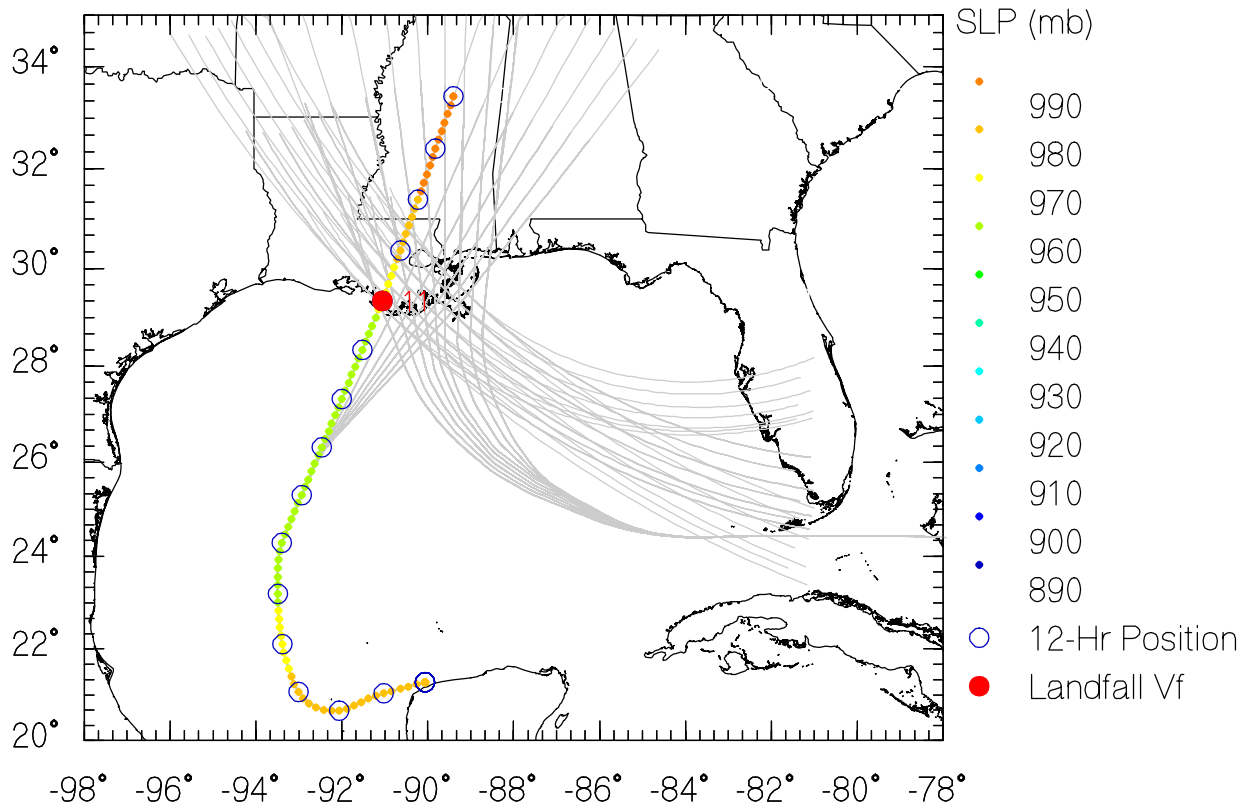

JRUN067 Data

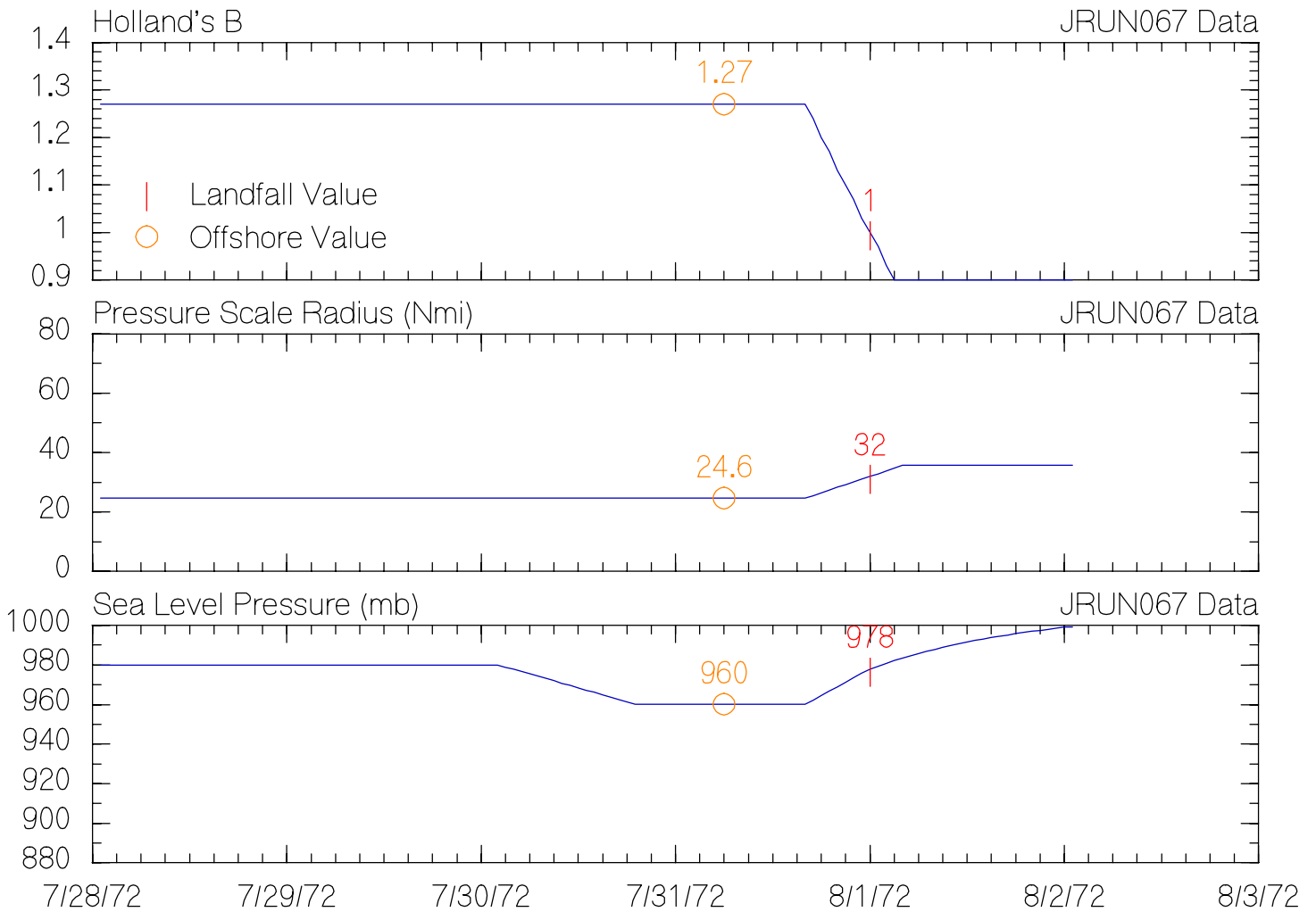
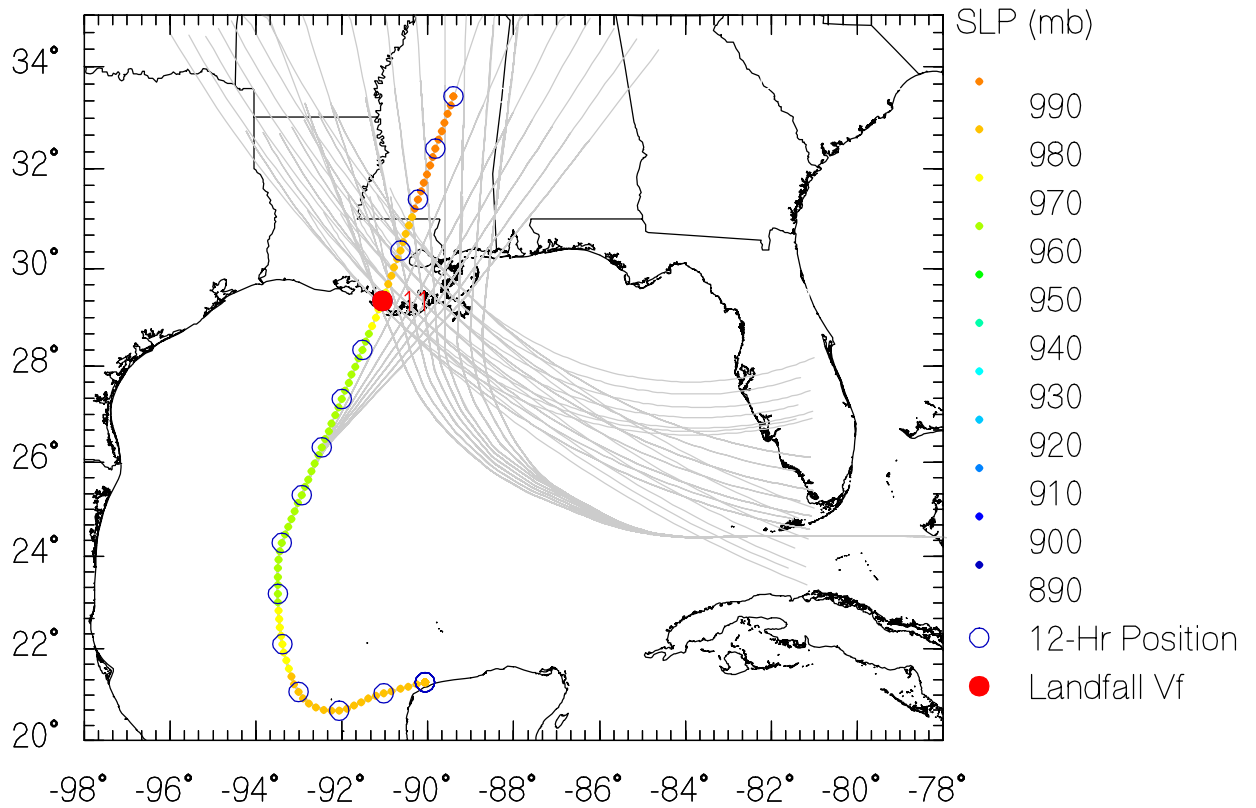

JRUN068 Data

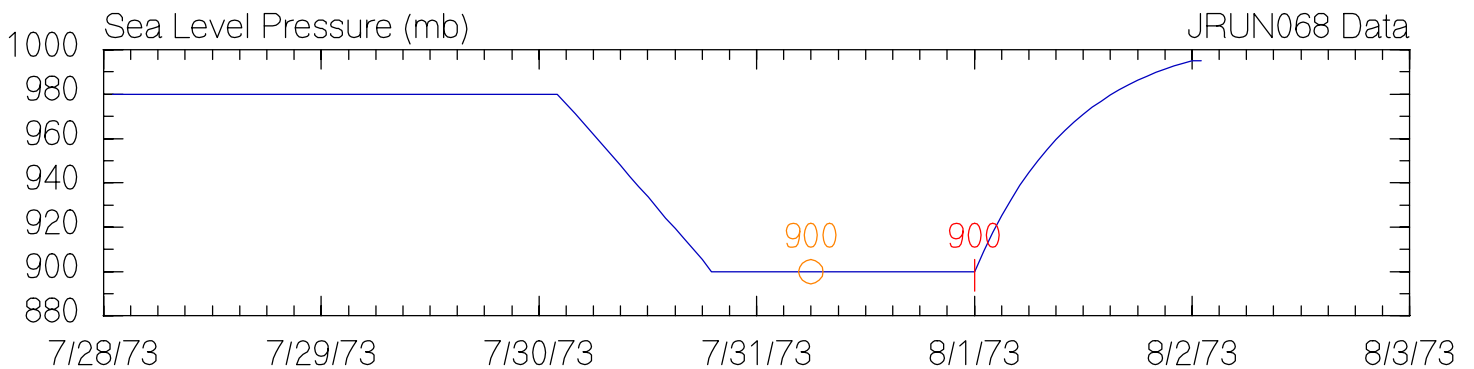
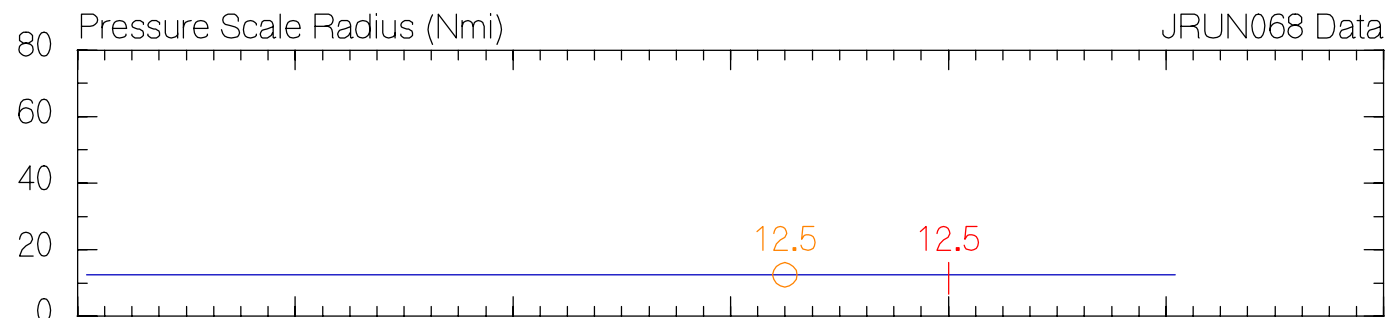
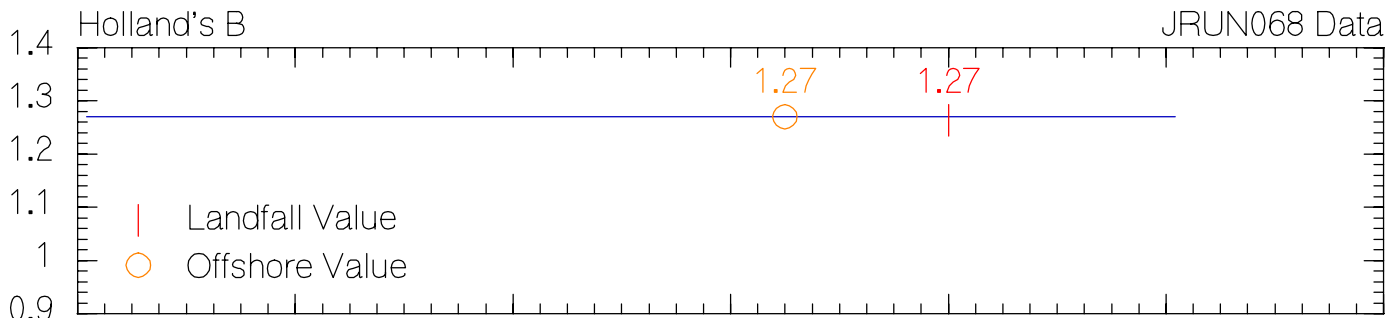
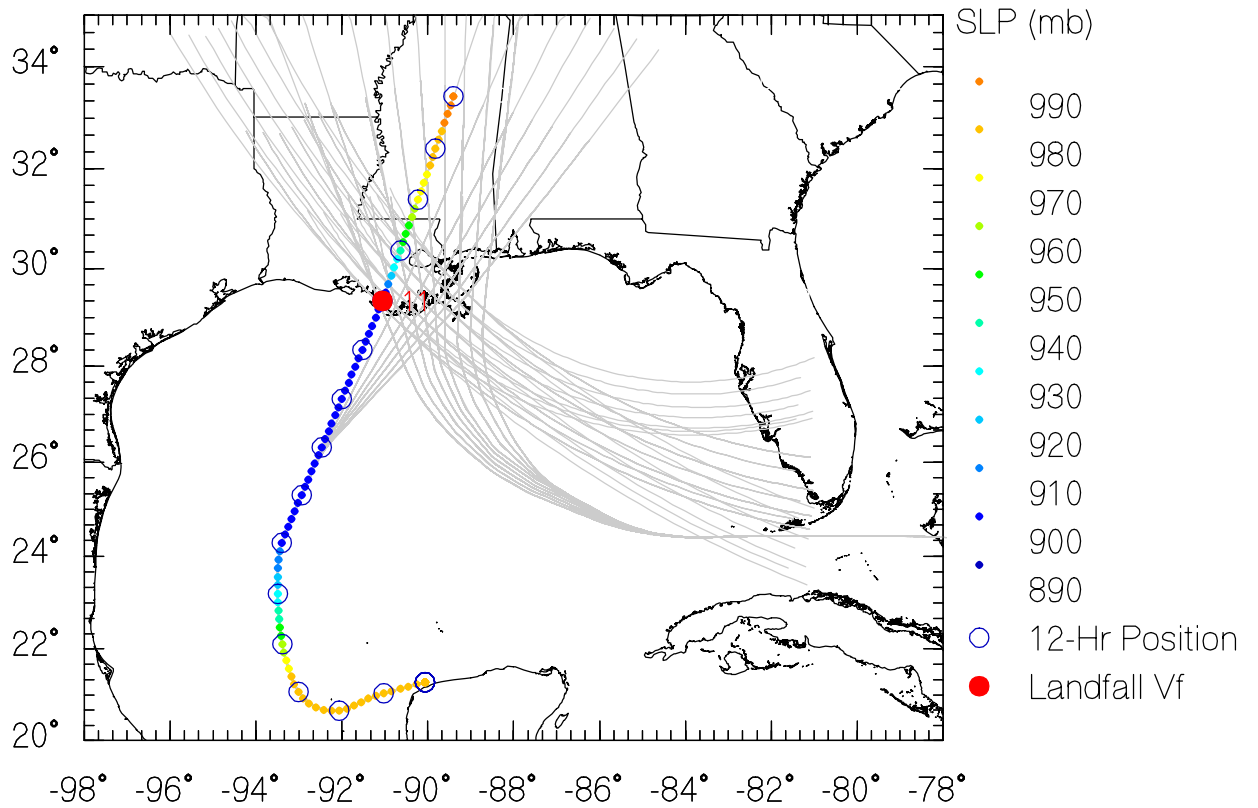

JRUN069 Data

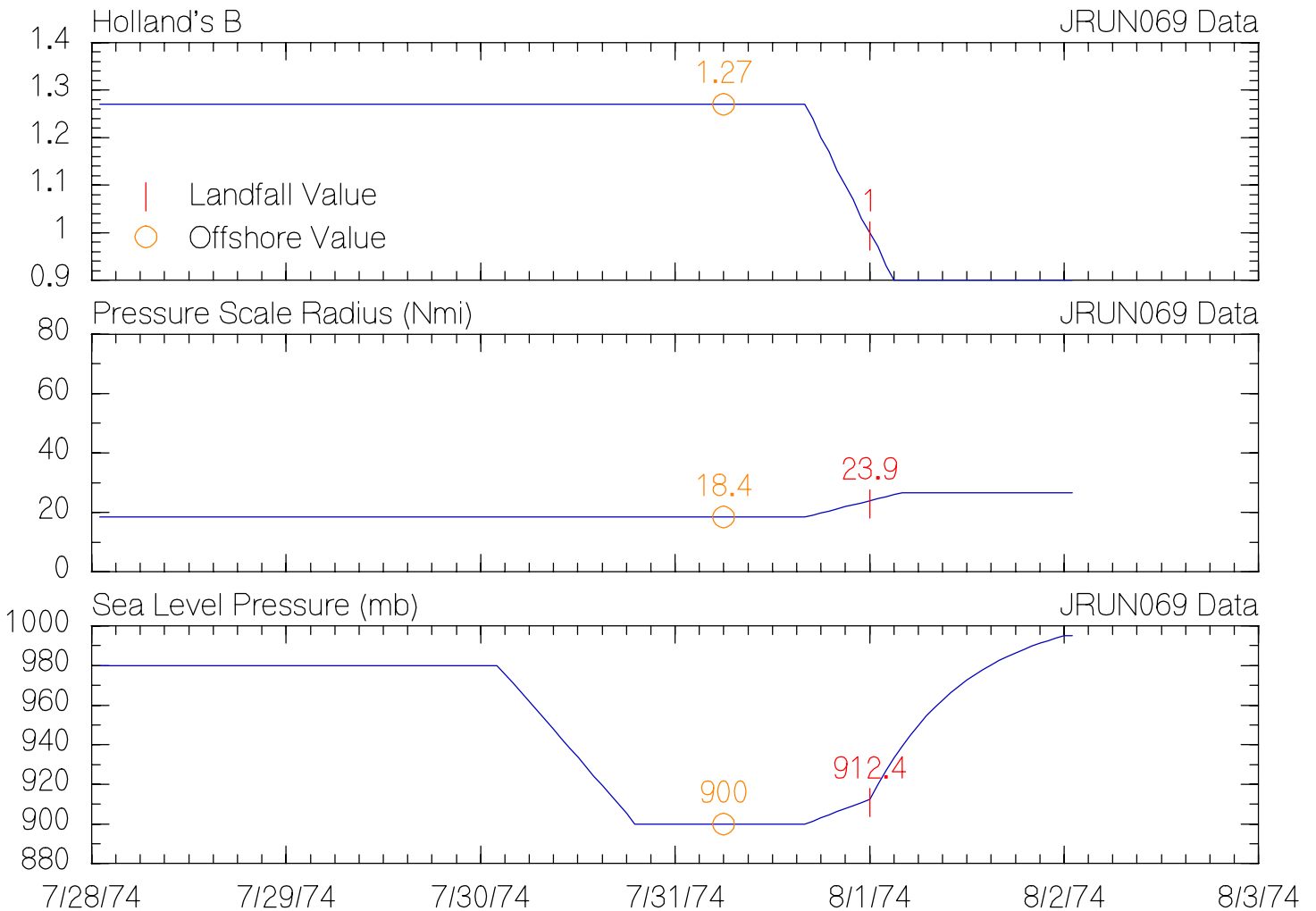
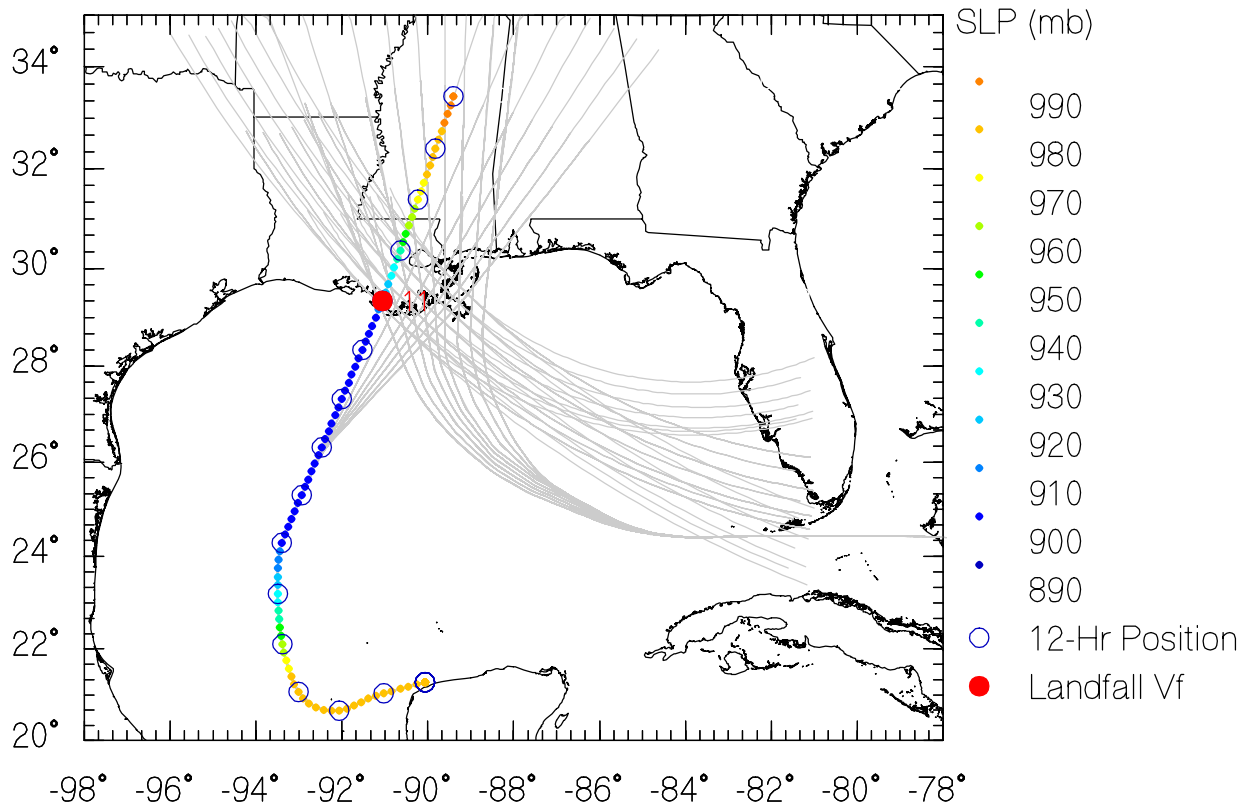

JRUN070 Data

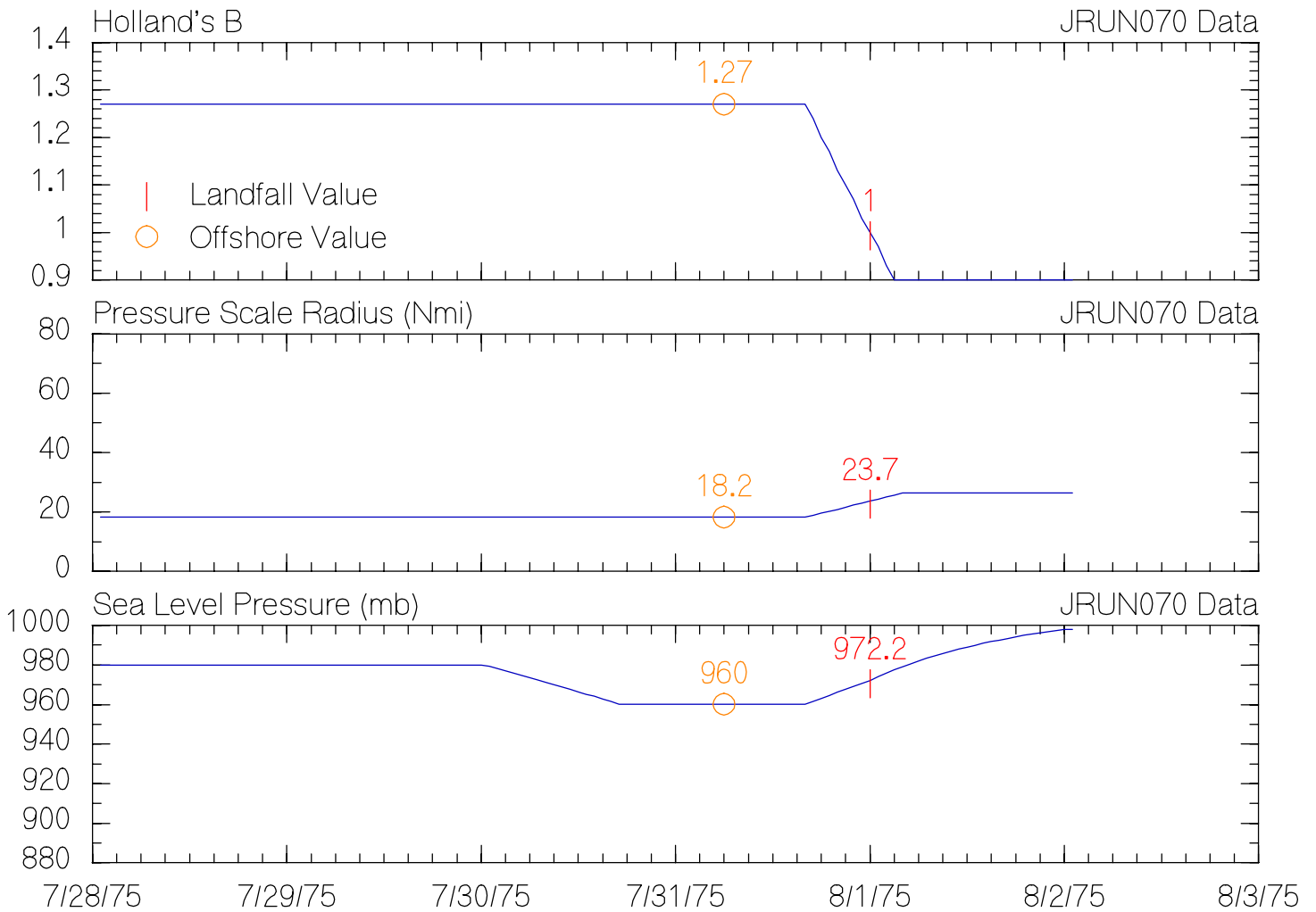
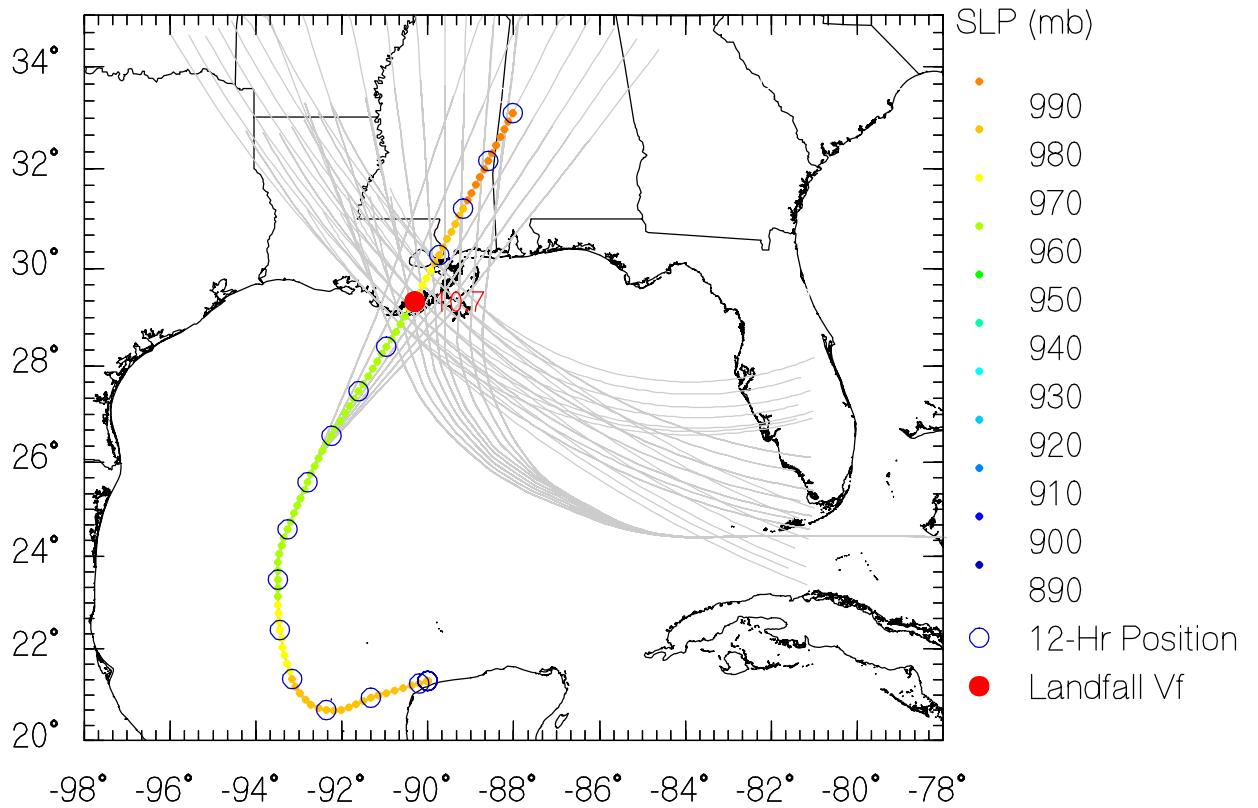

JRUN071 Data

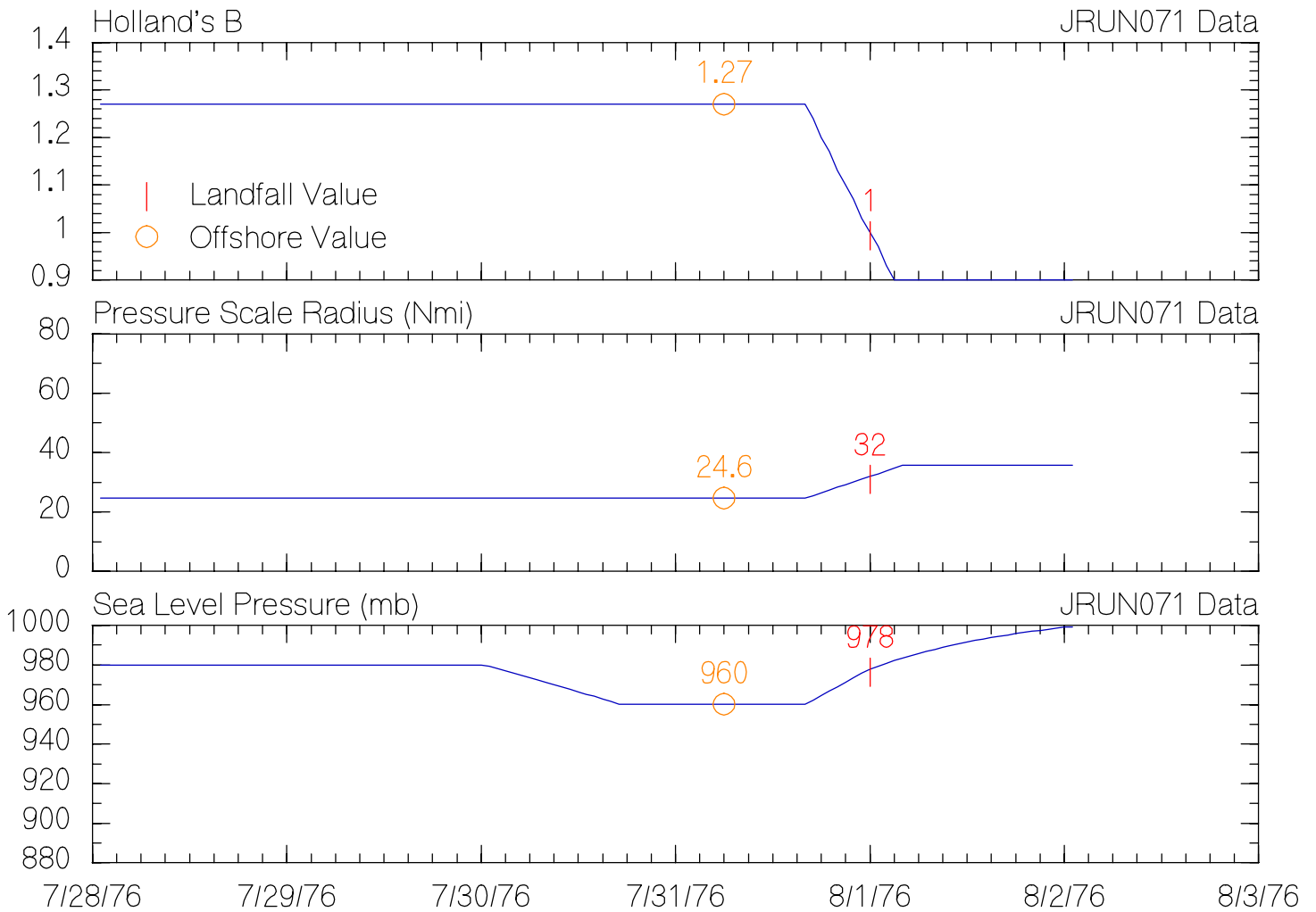
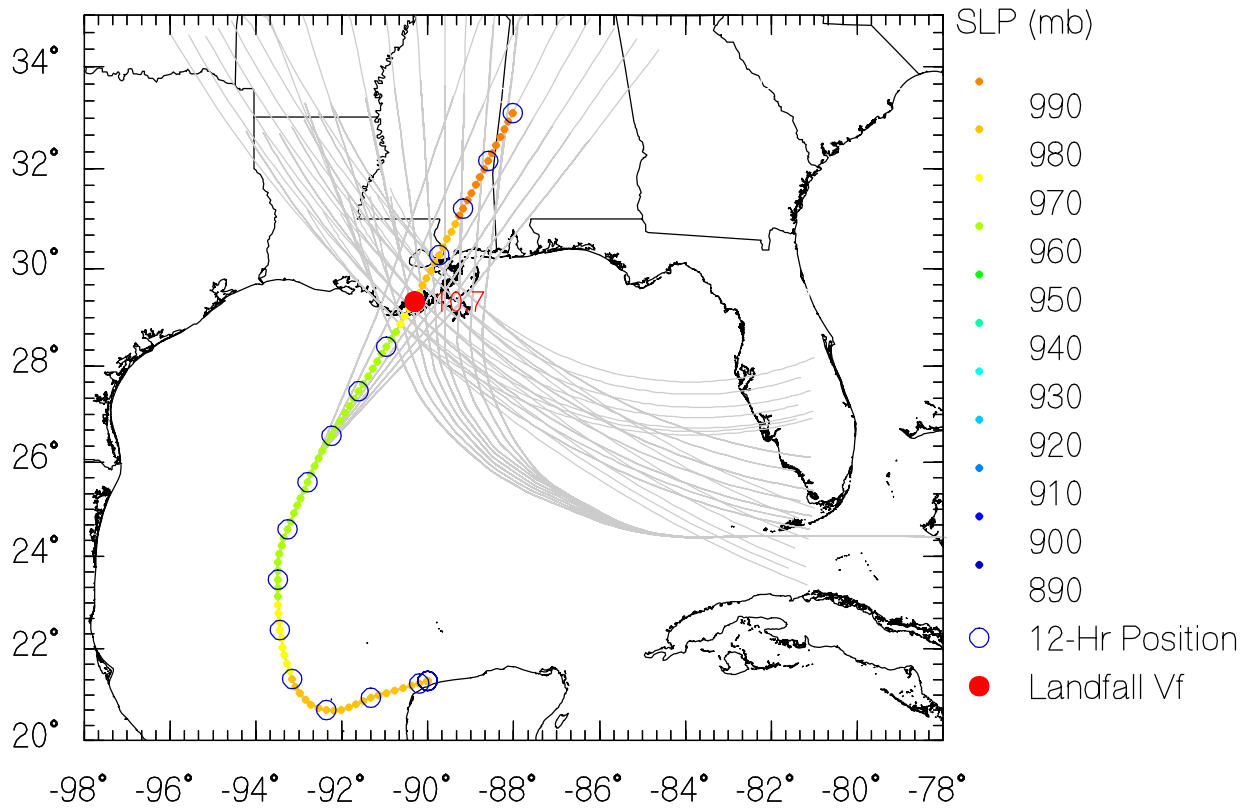

JRUN072 Data

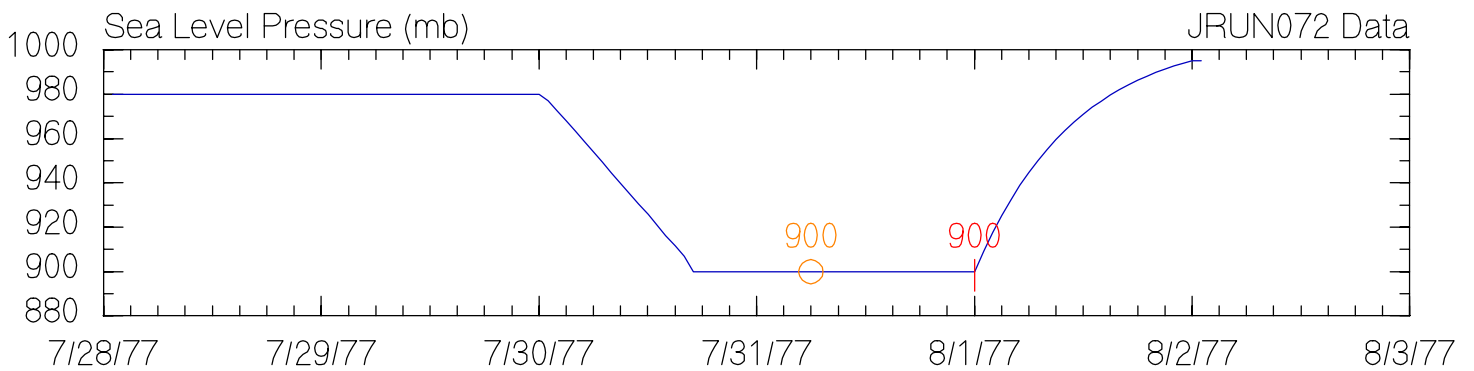
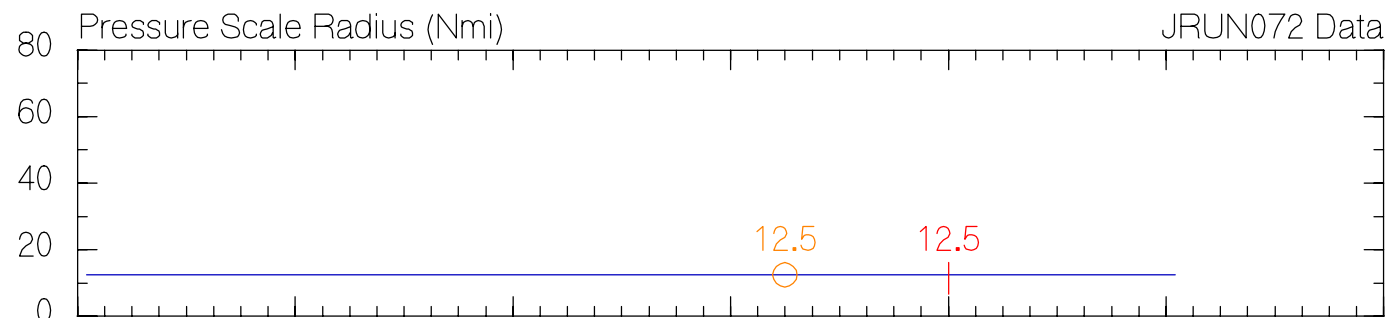
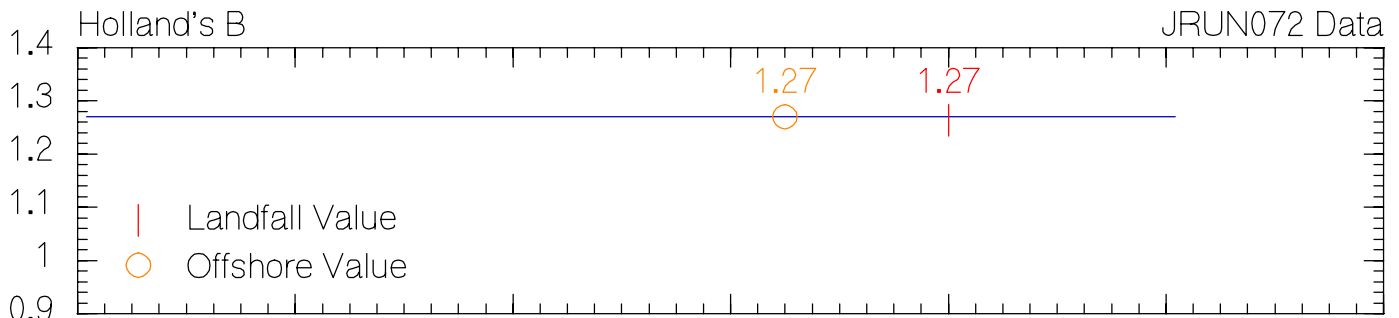
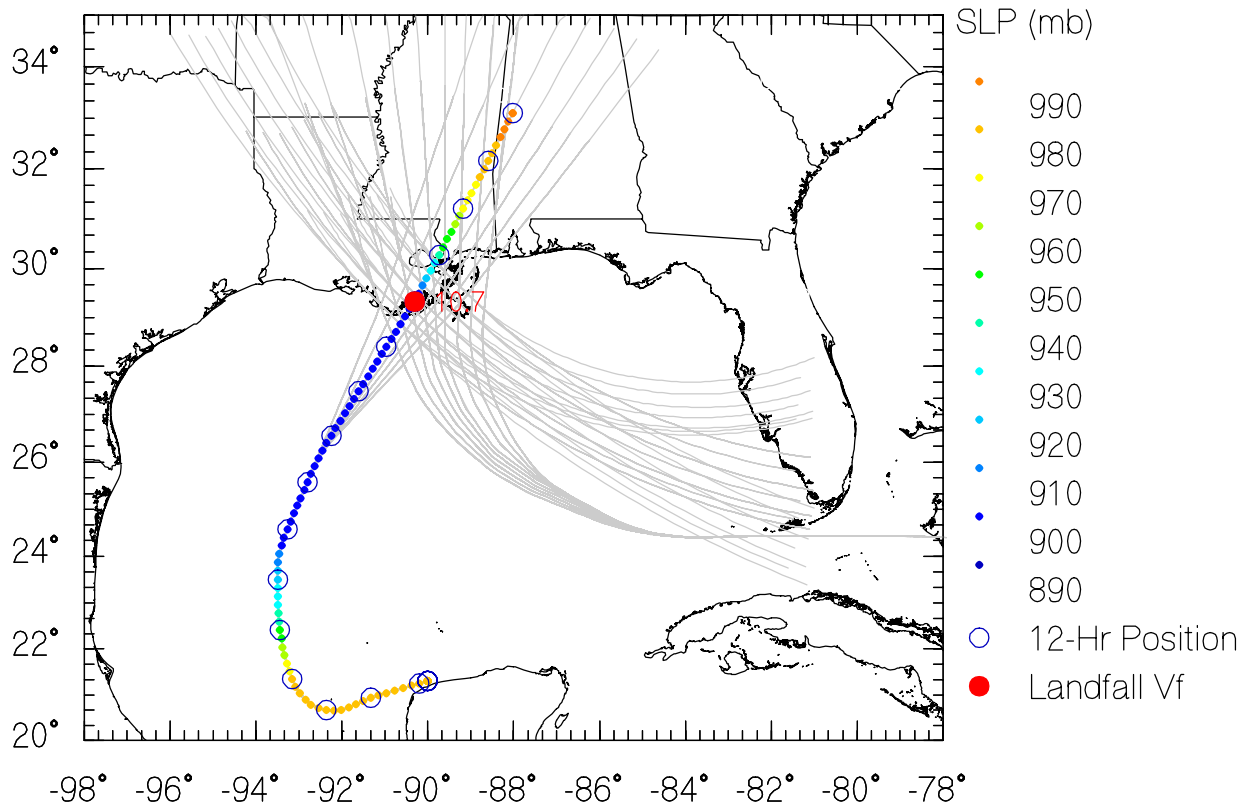

JRUN073 Data

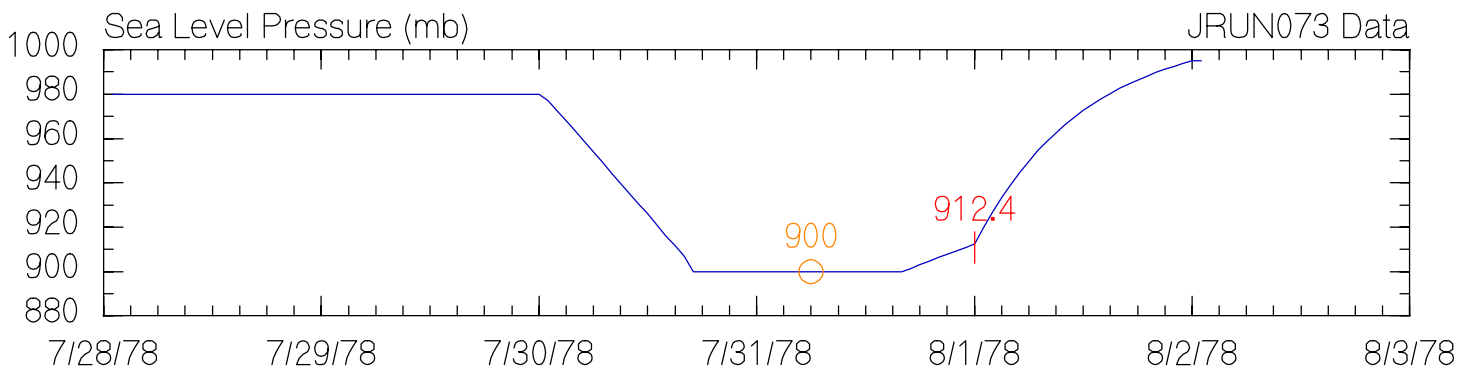
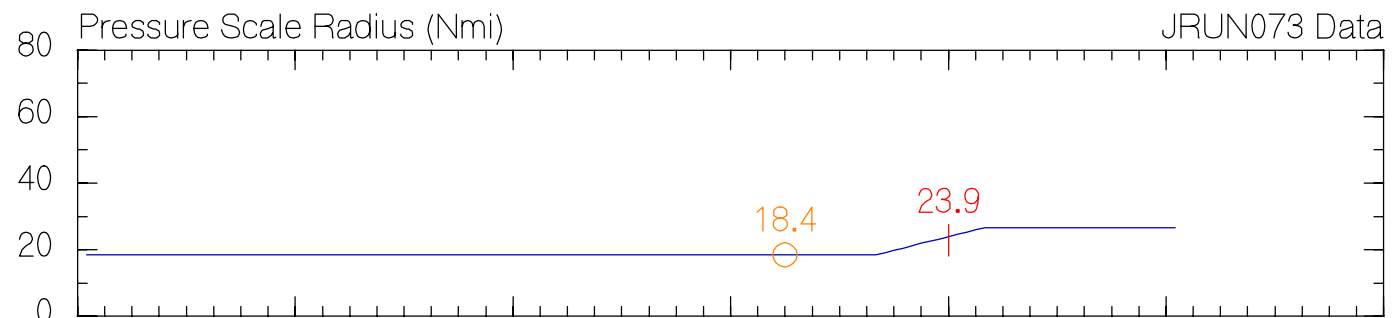
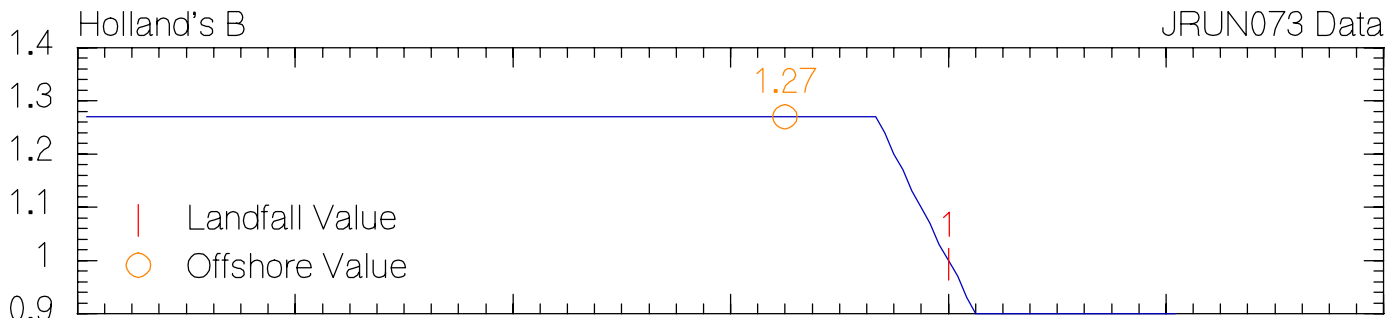
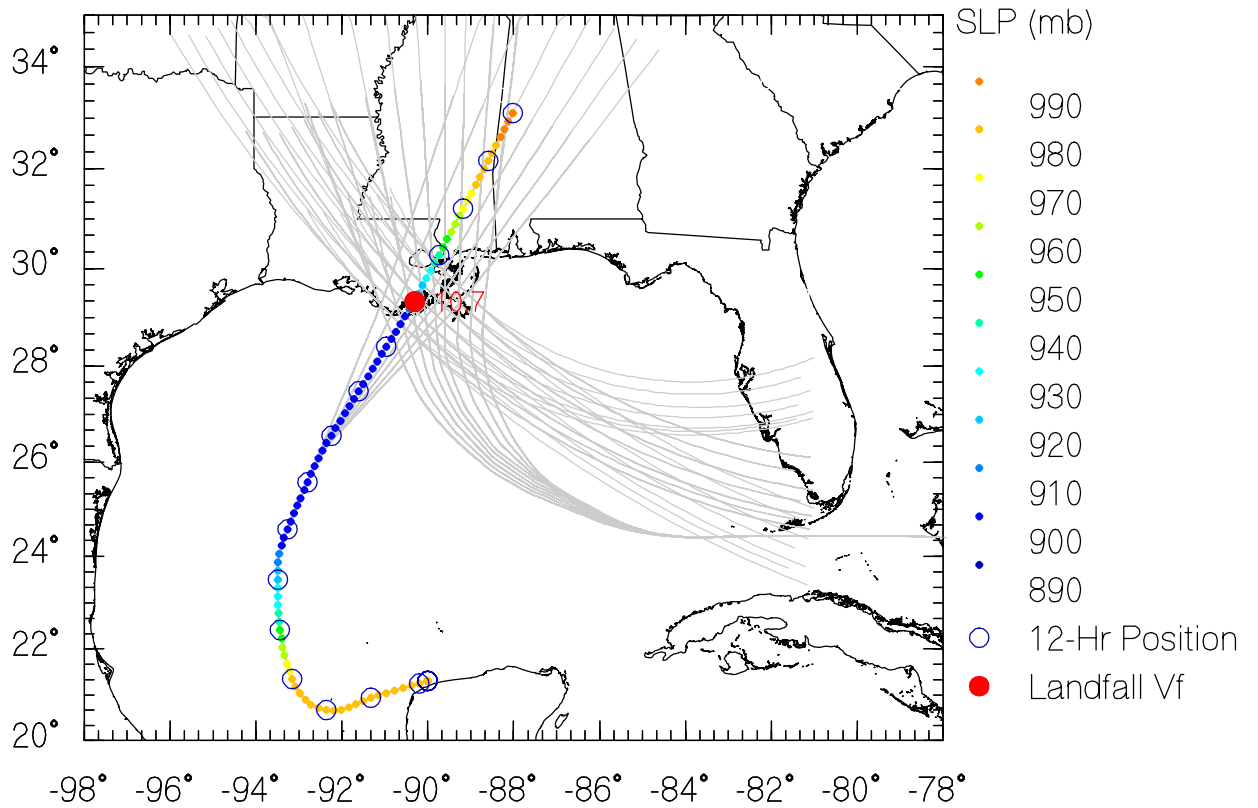

JRUN074 Data

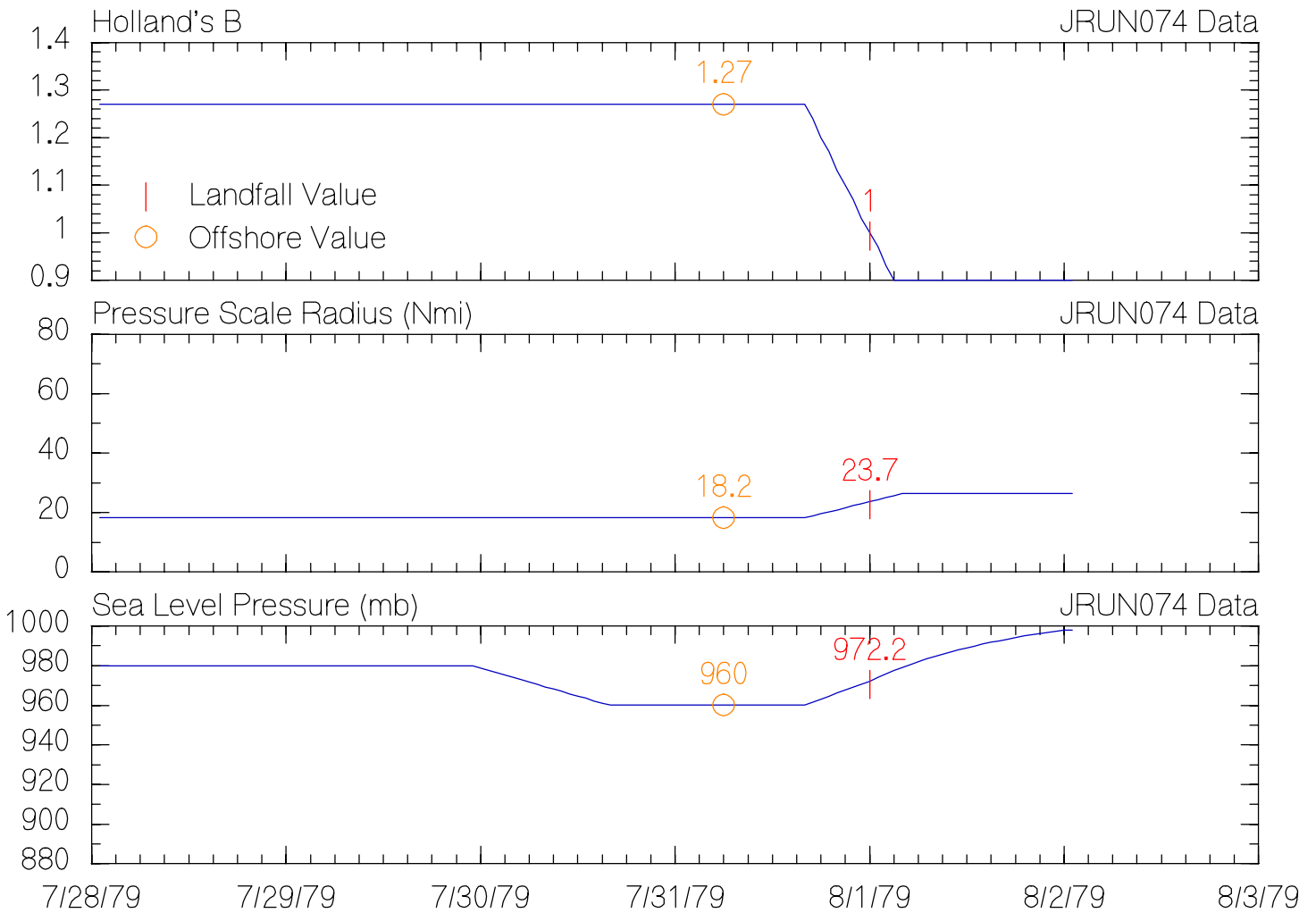
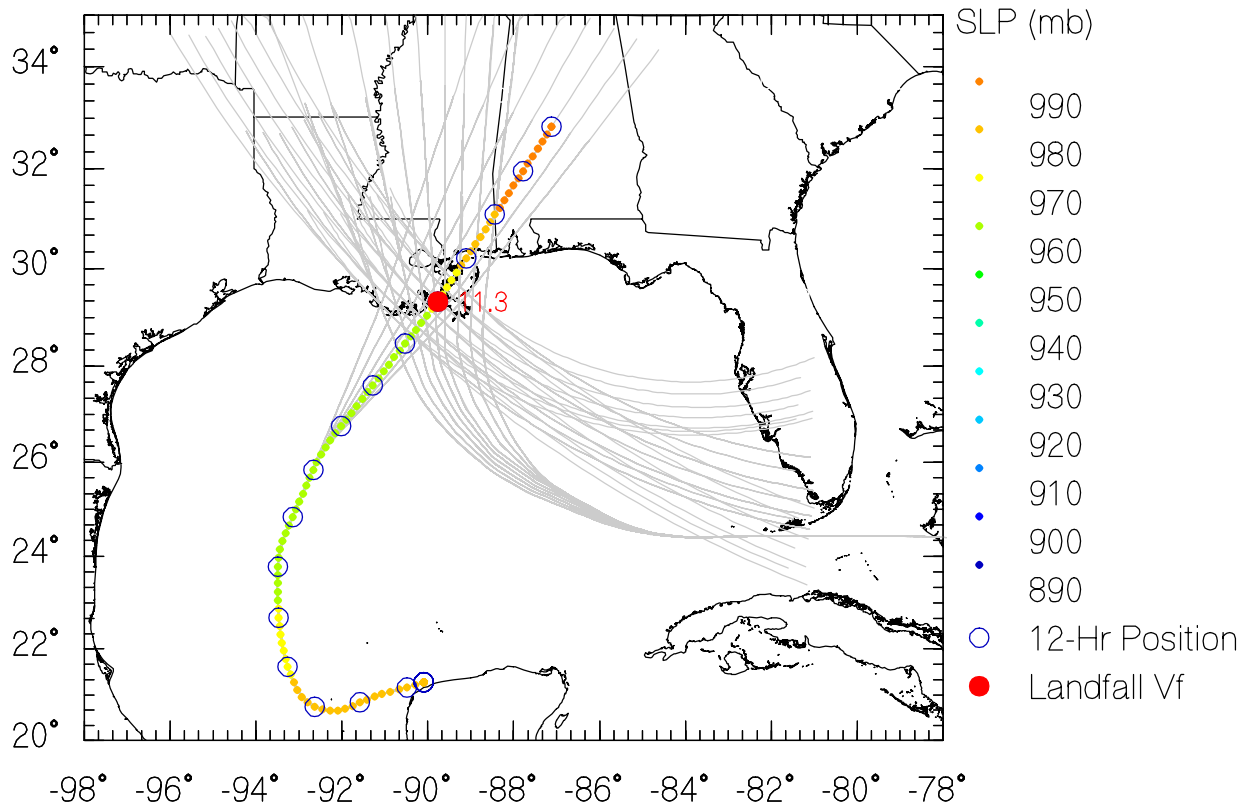

JRUN075 Data

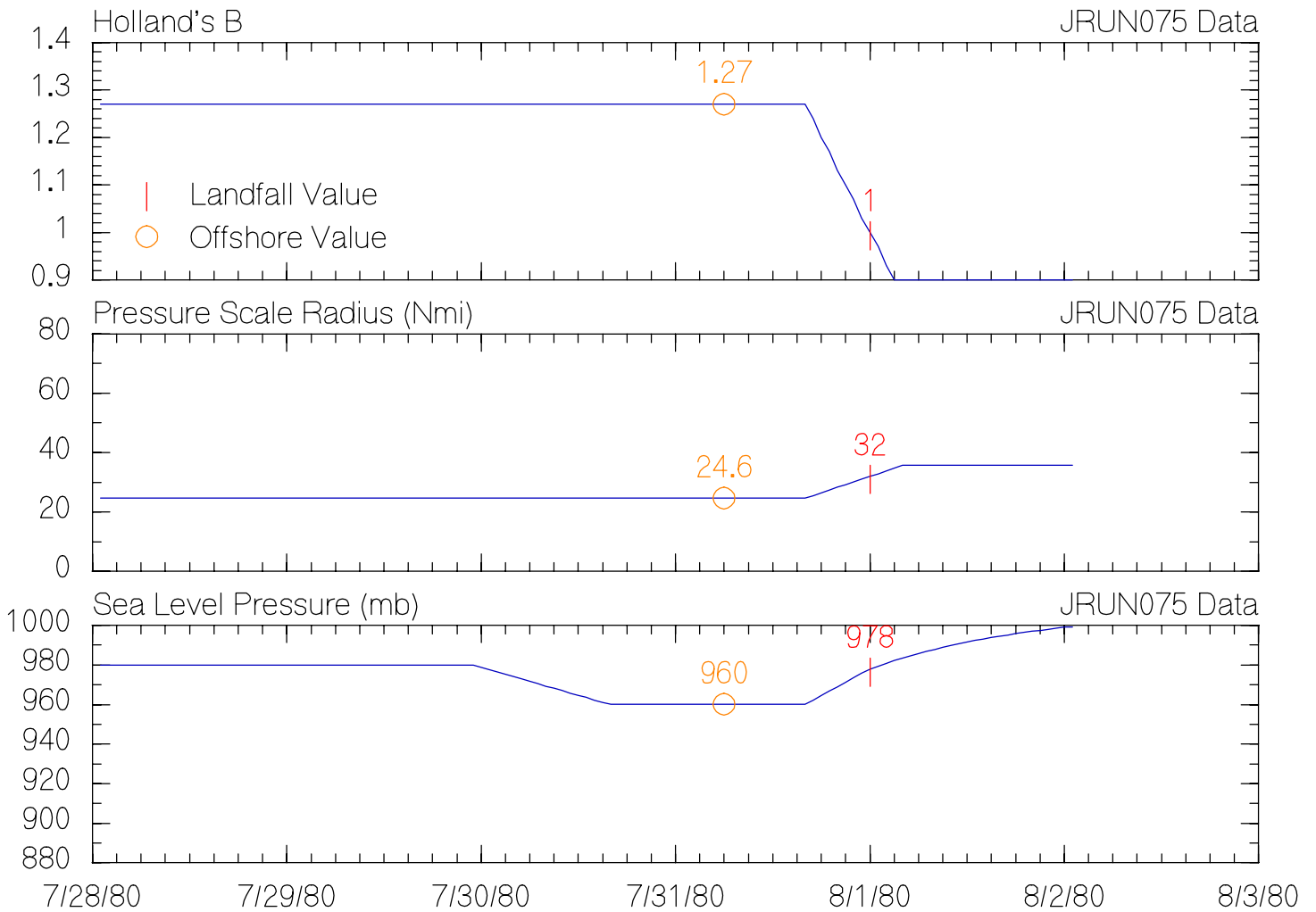
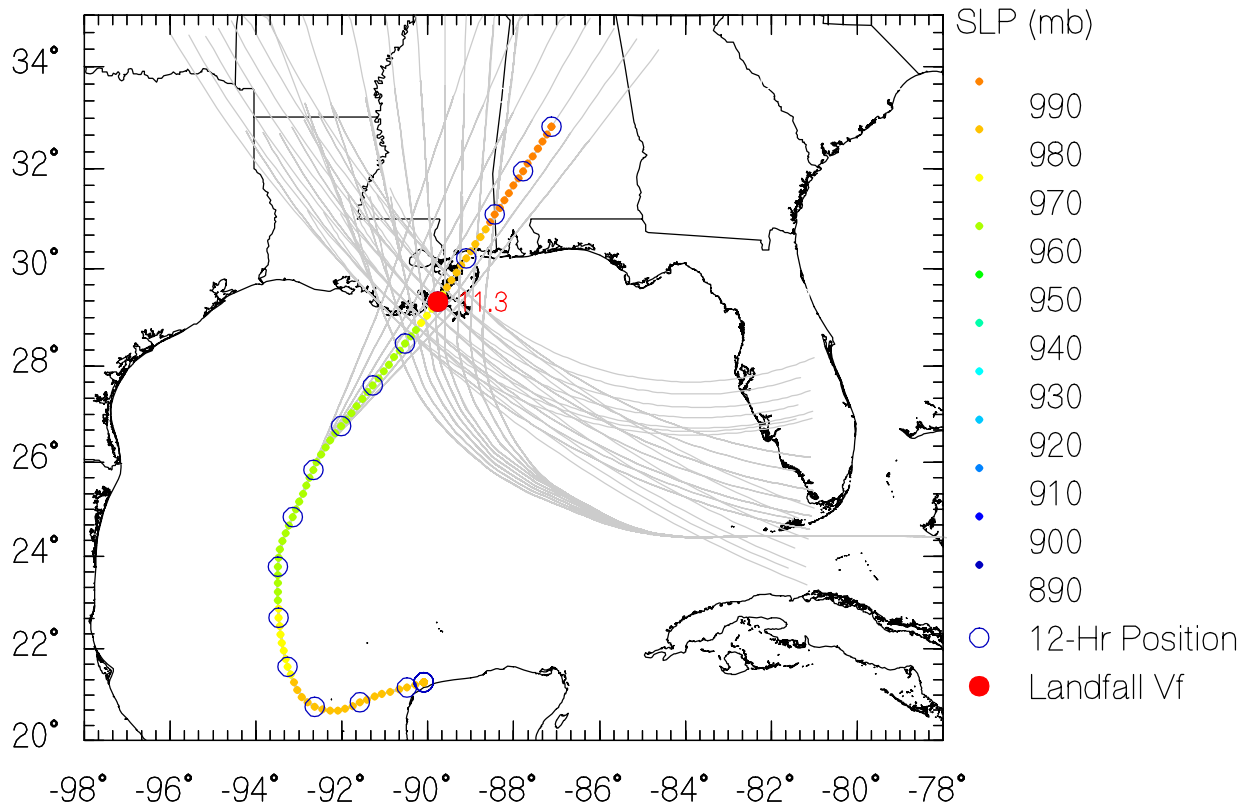

JRUN076 Data

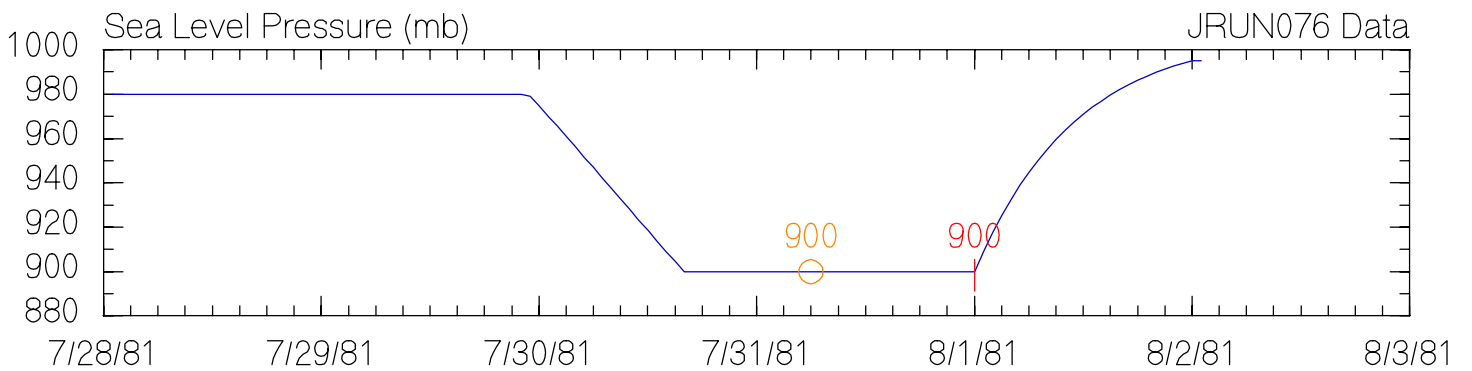
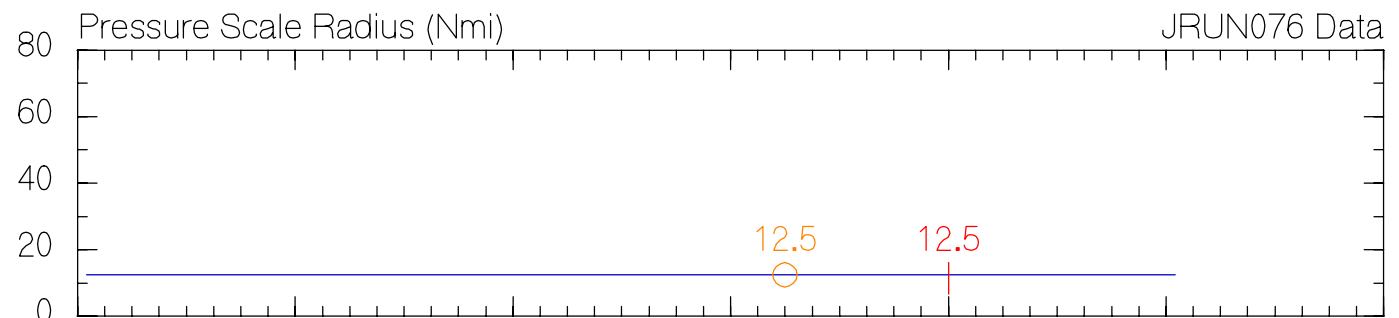
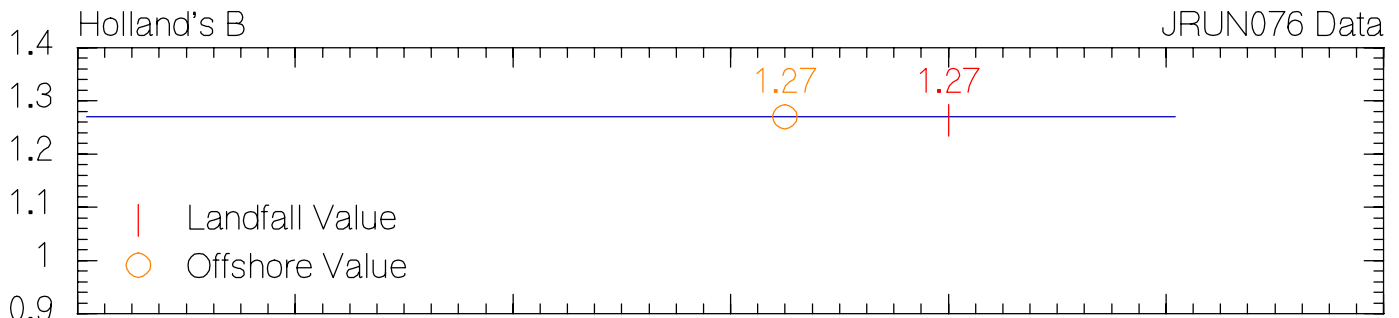
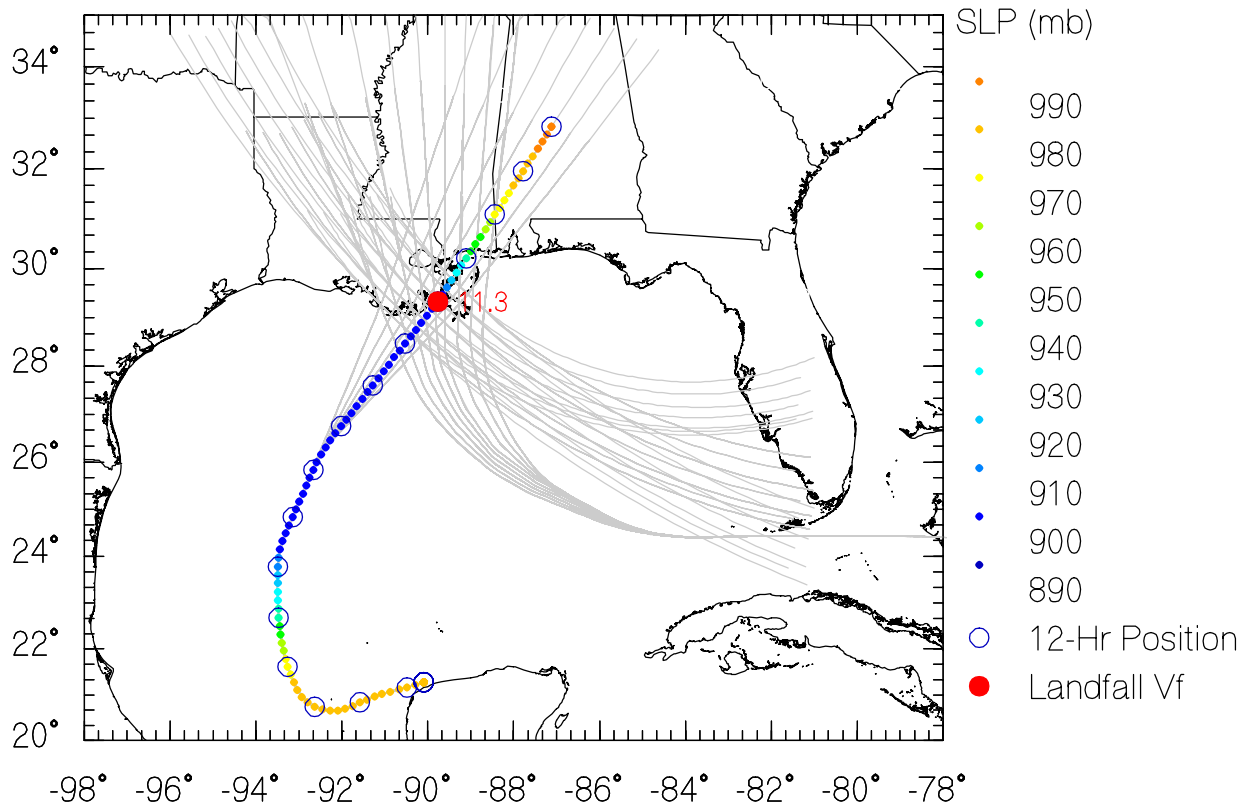

JRUN077 Data

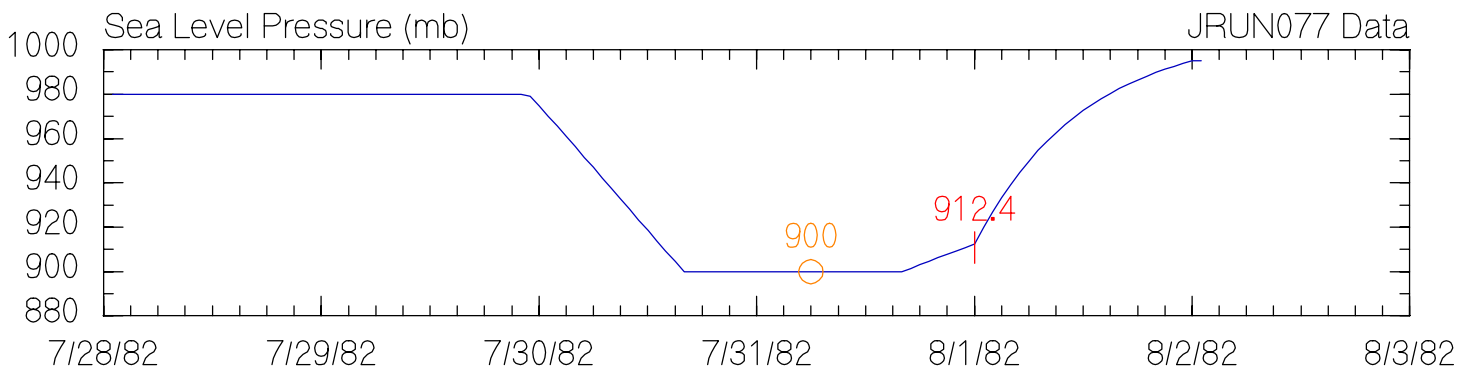
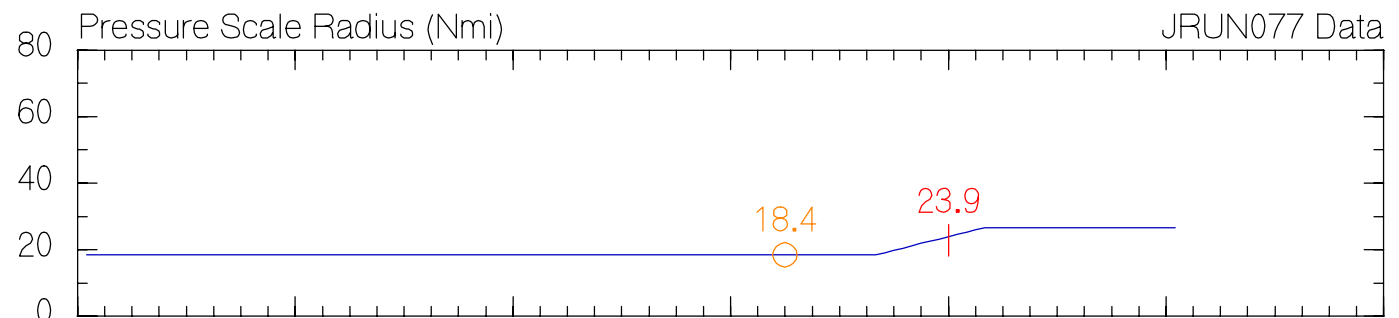
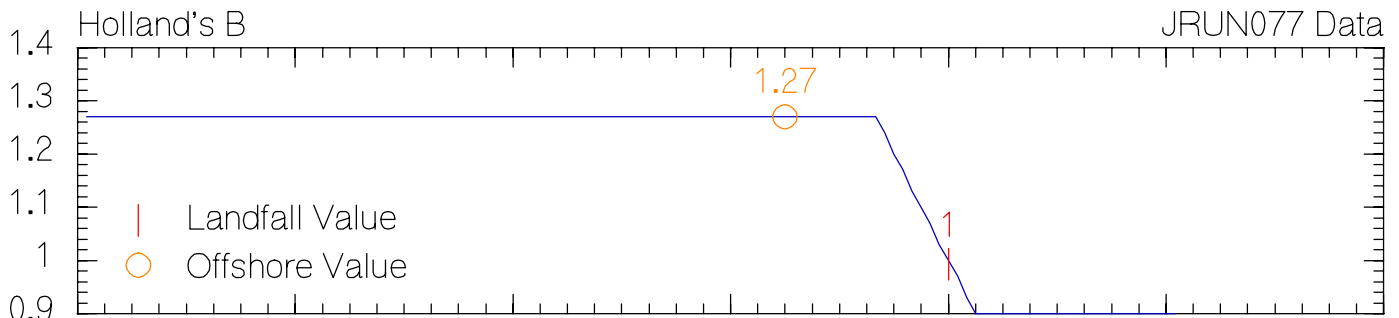
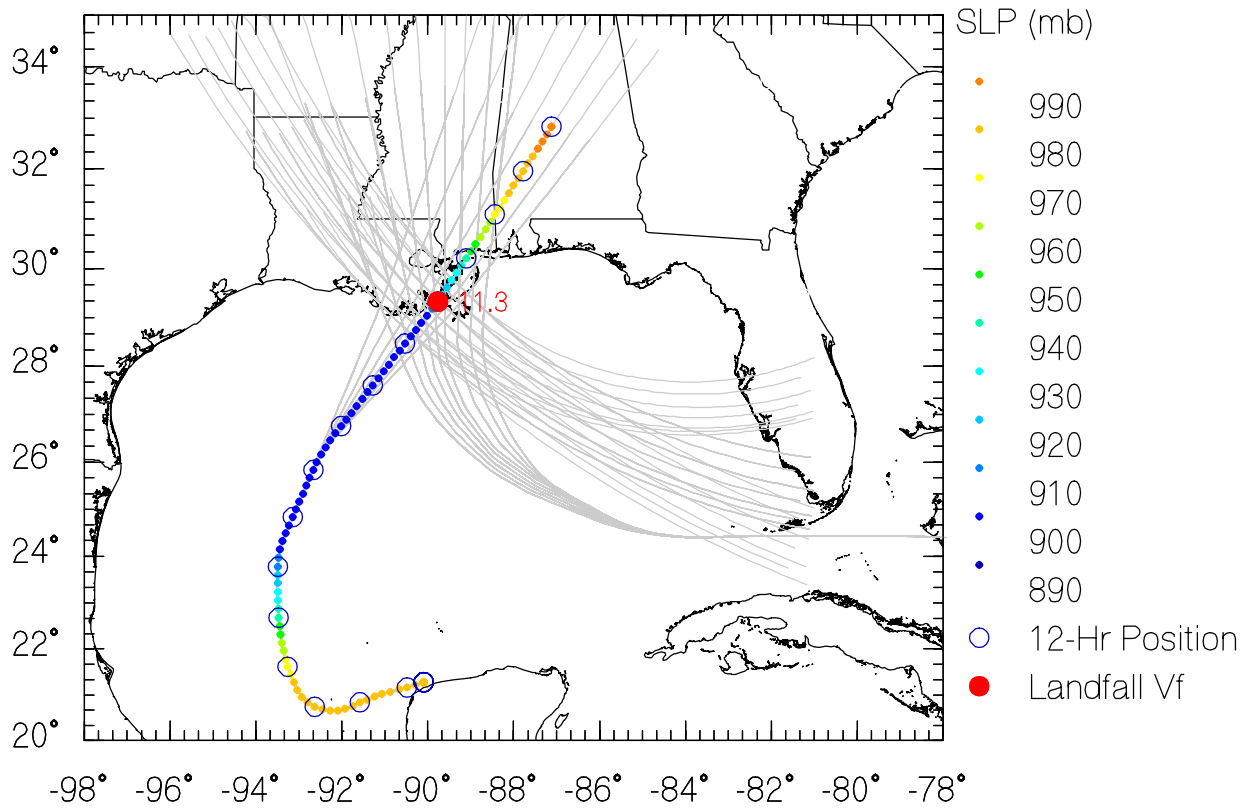

JRUN078 Data

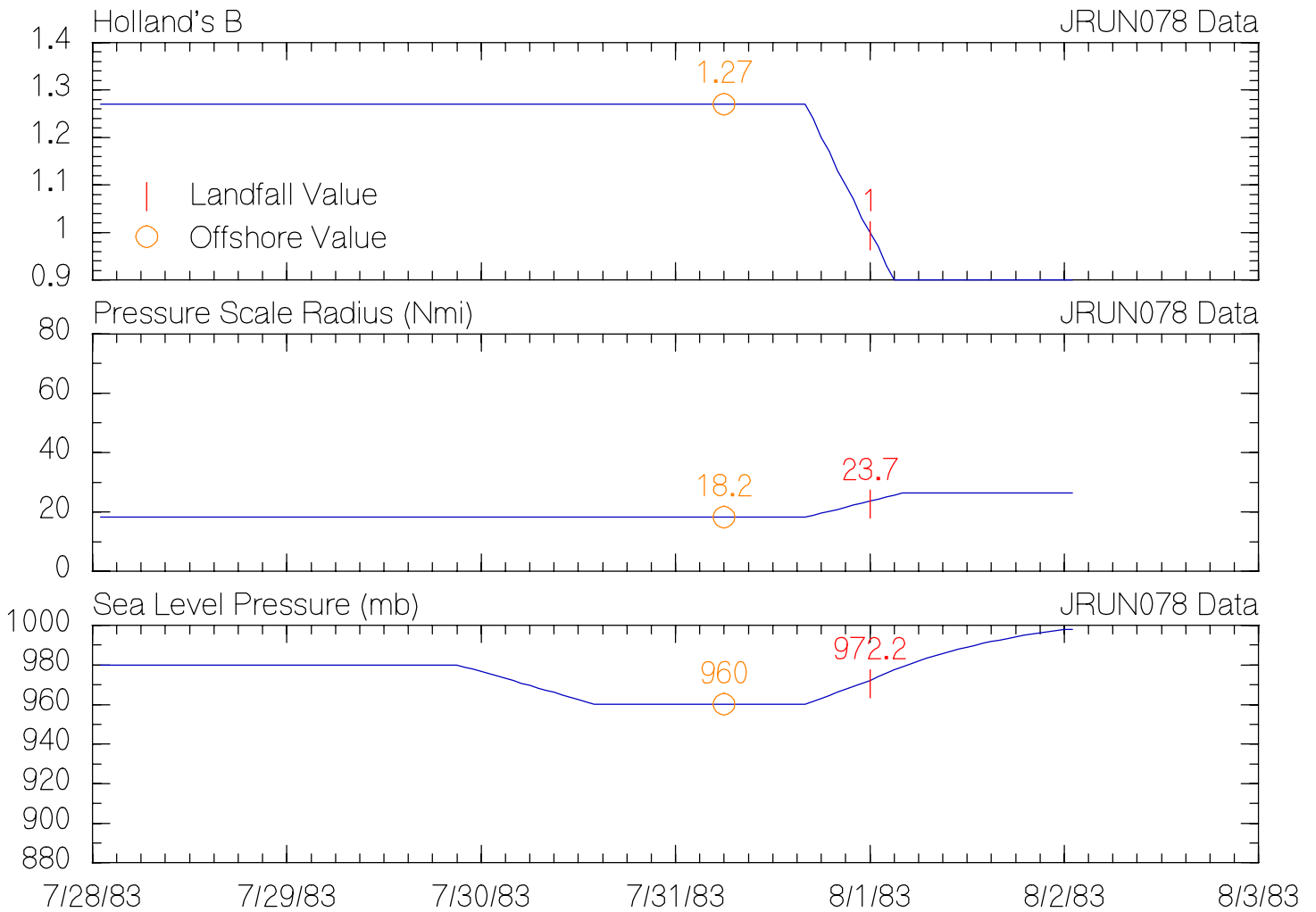
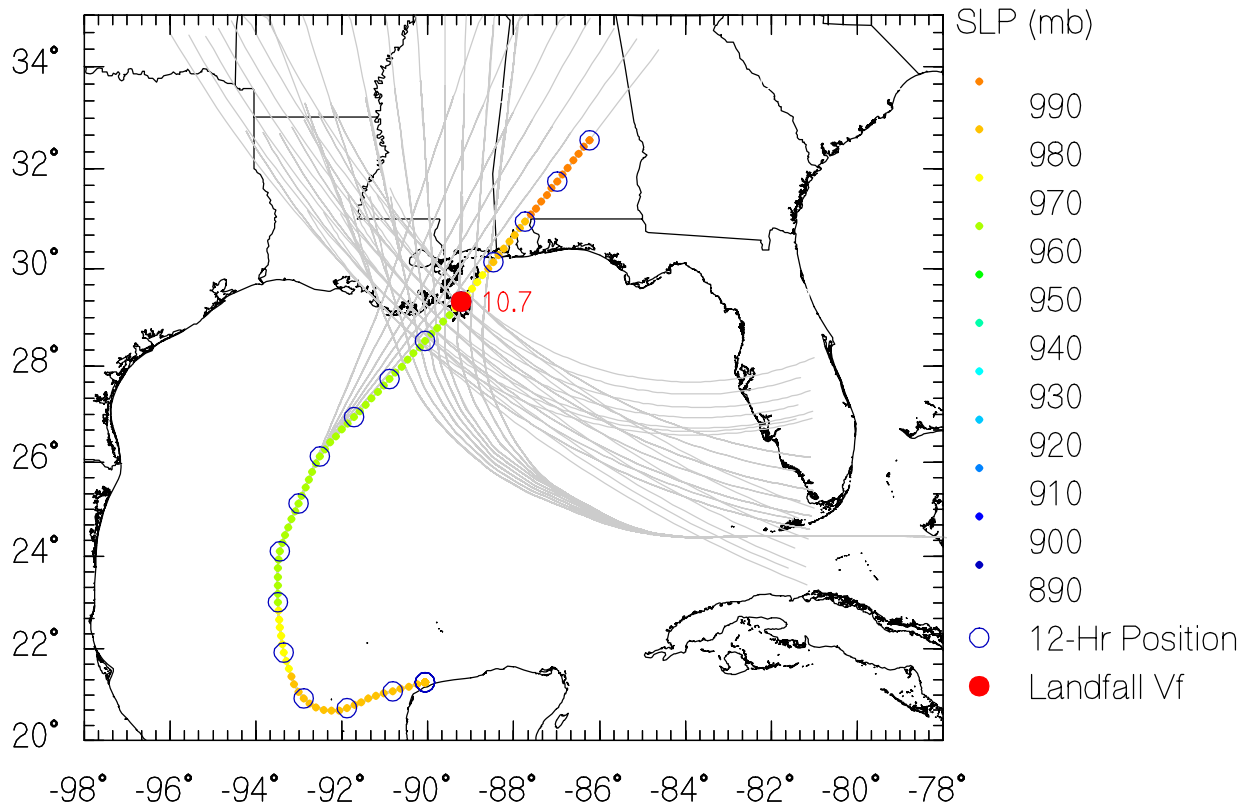

JRUN079 Data

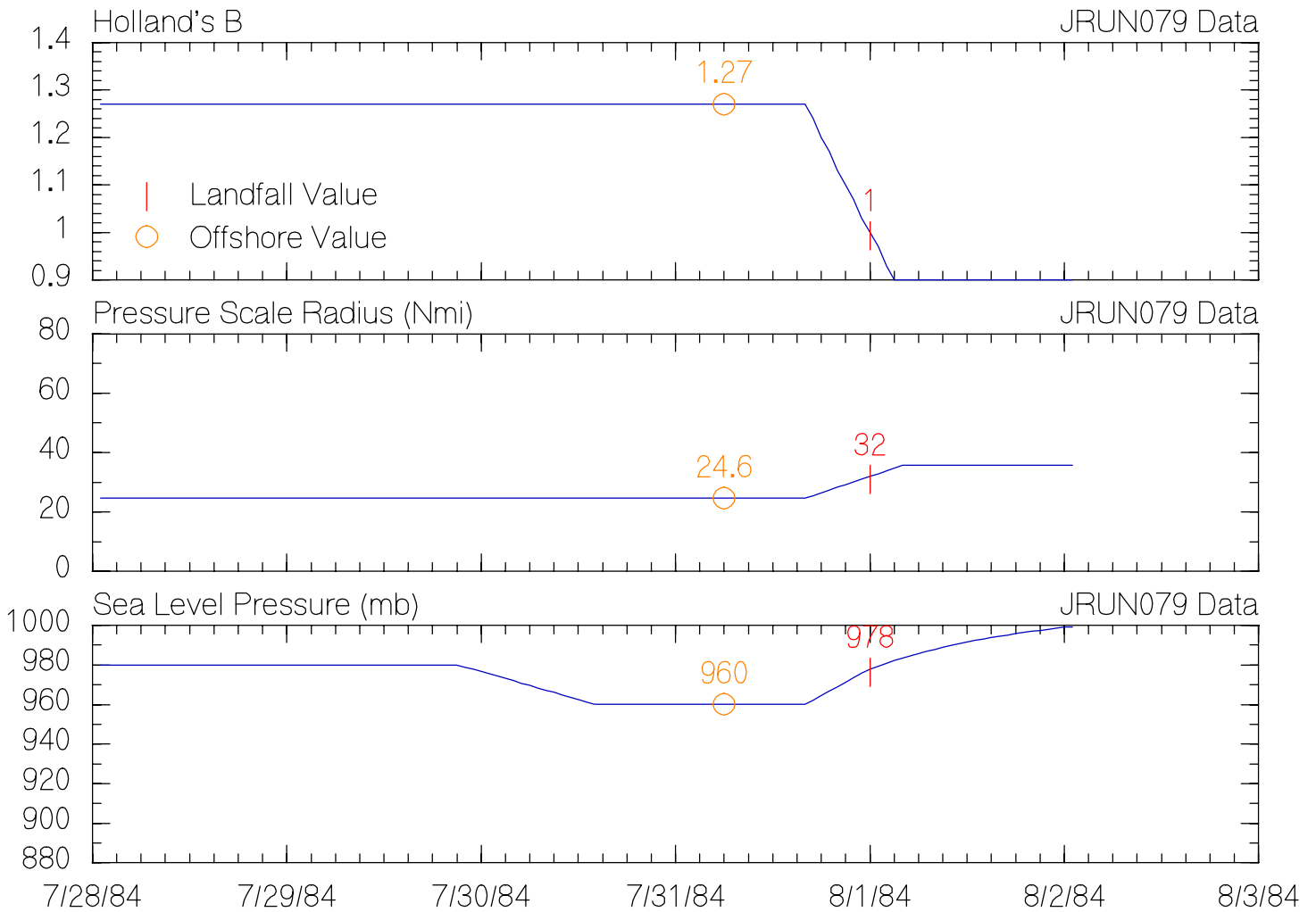
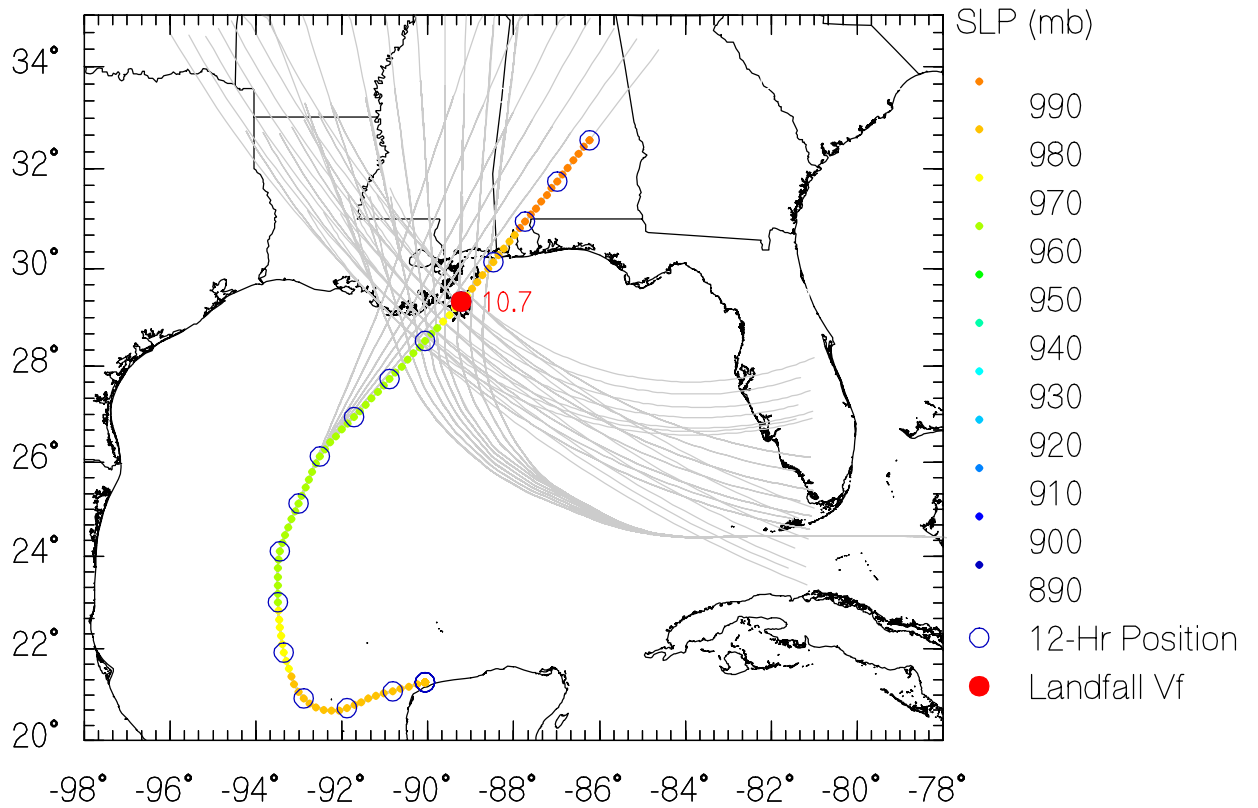

JRUN080 Data

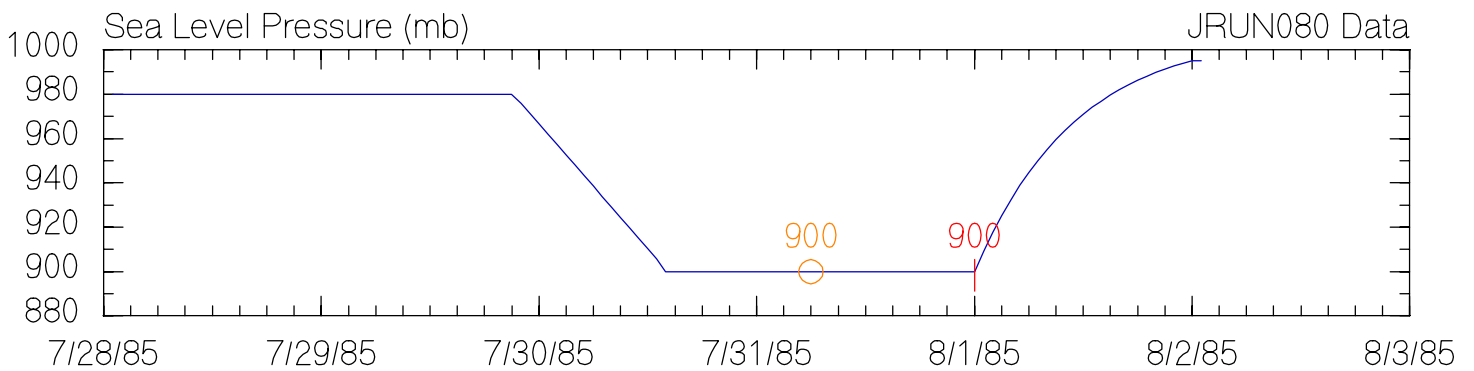
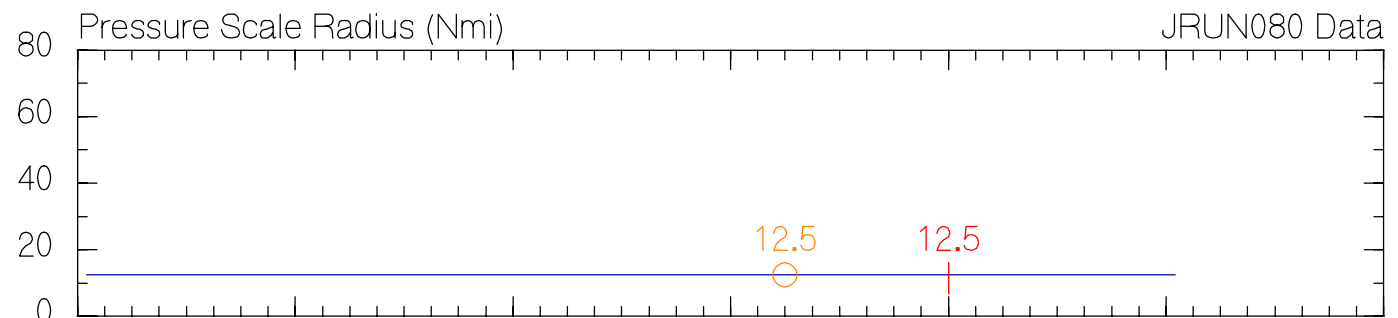
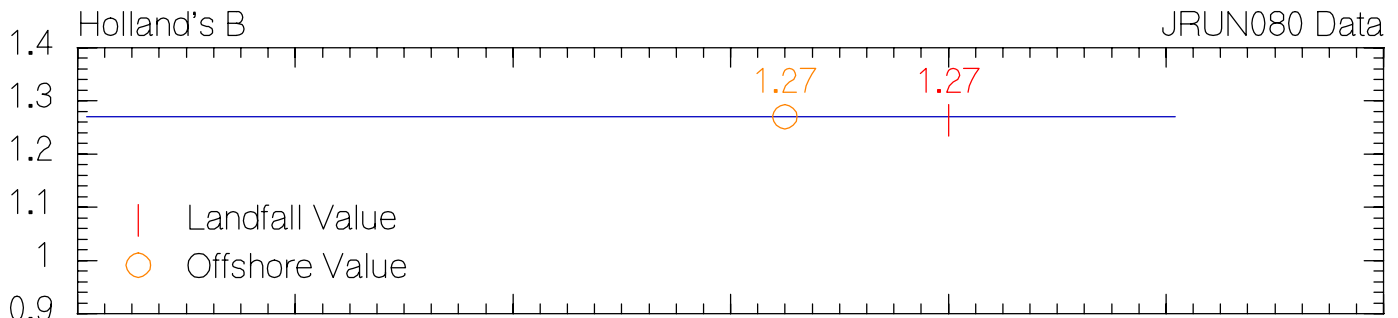
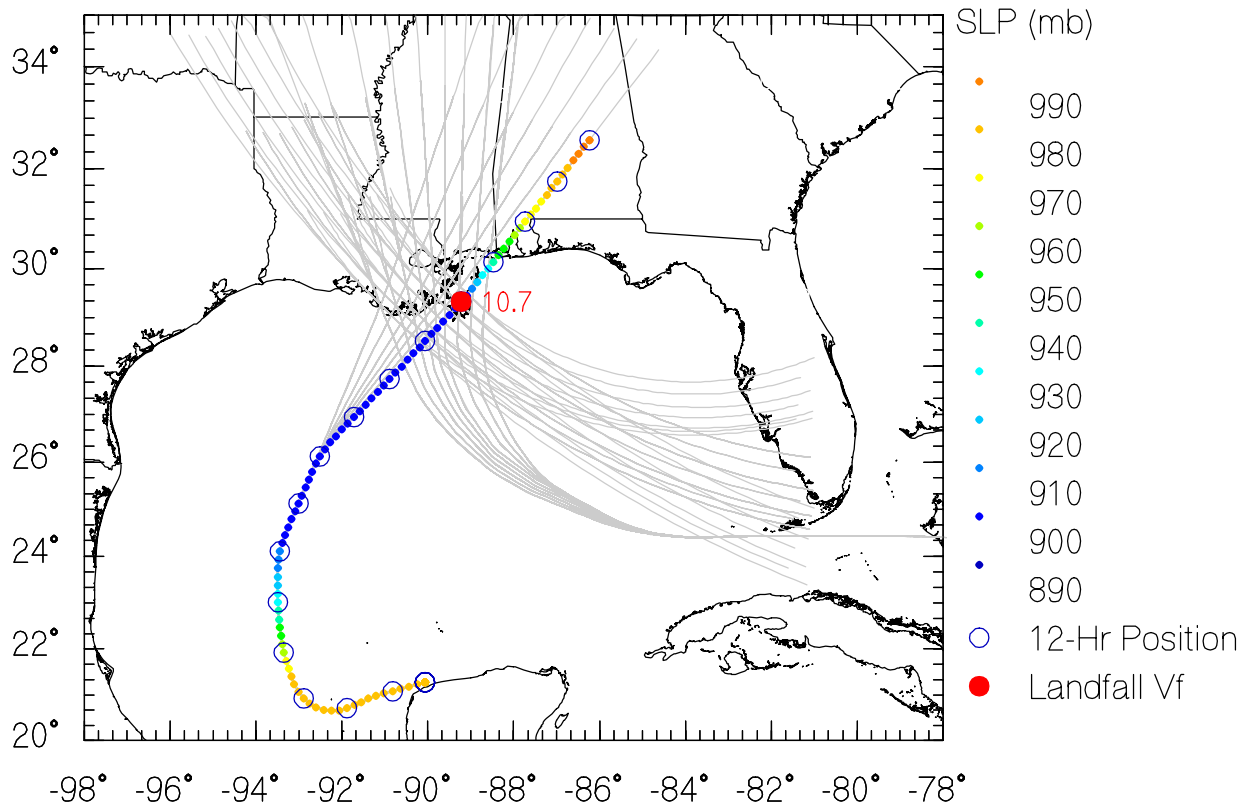

JRUN081 Data

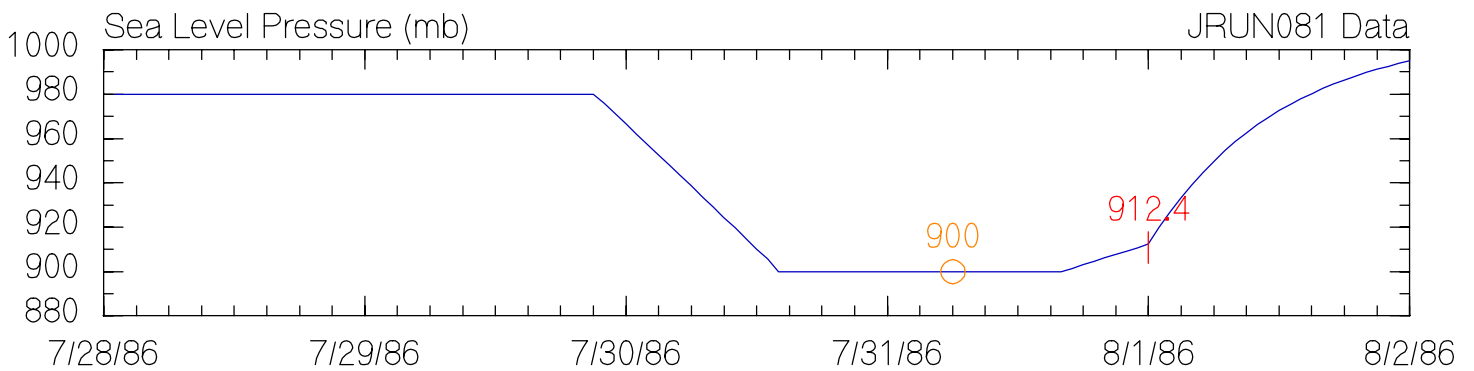
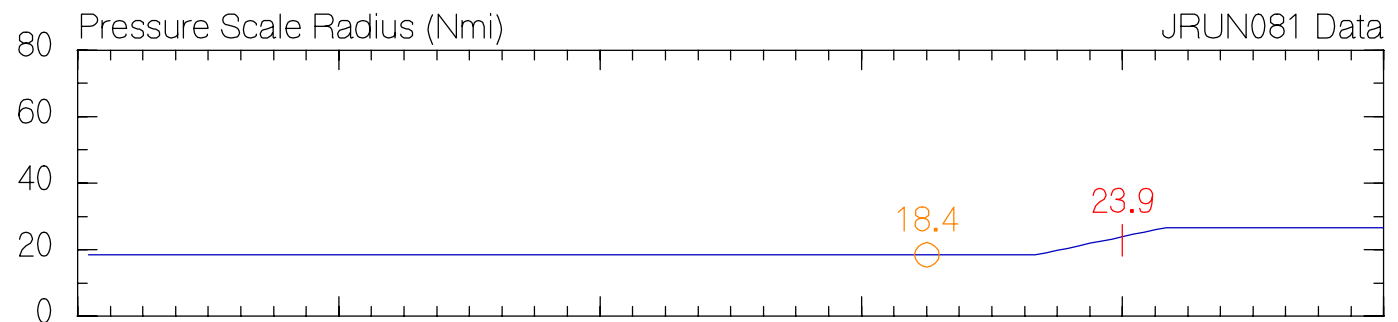
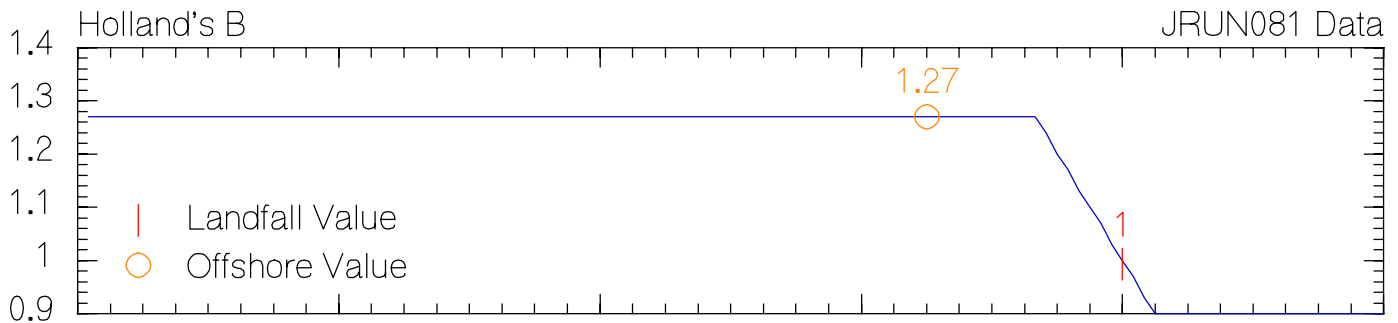
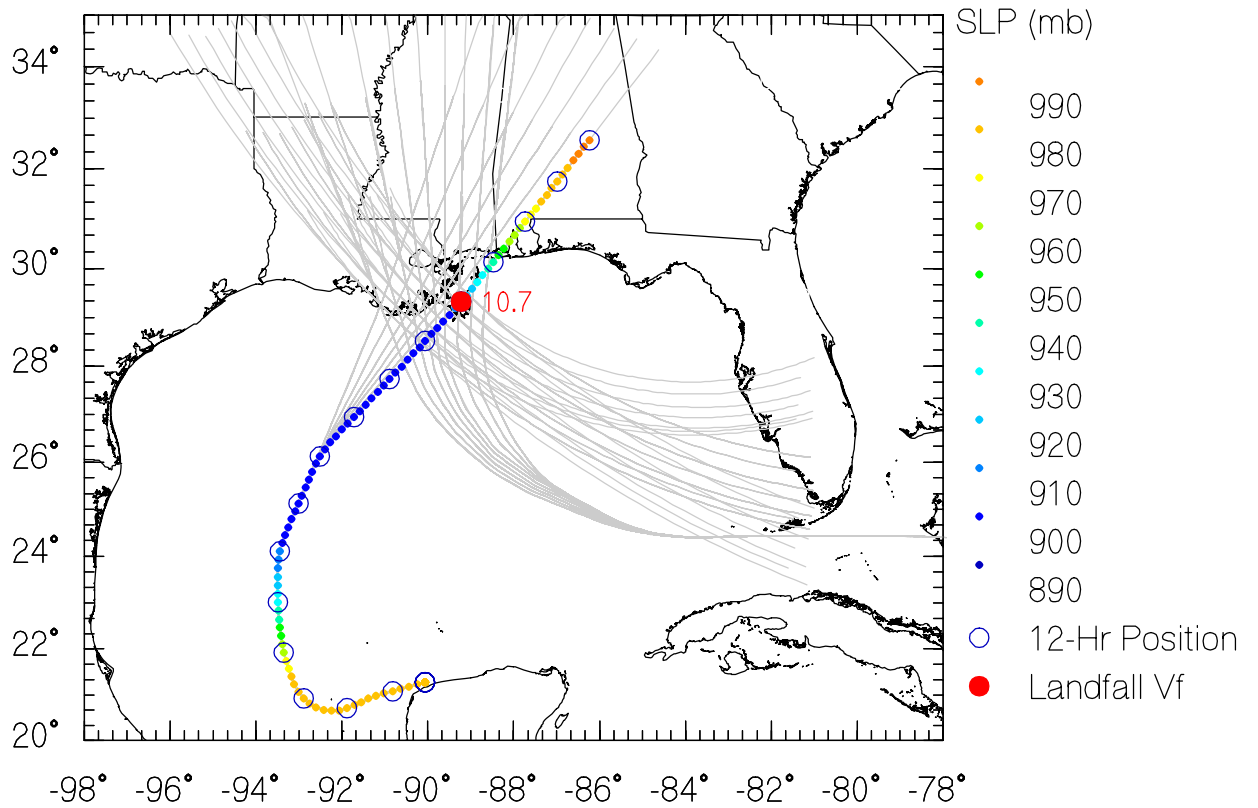

JRUN082 Data

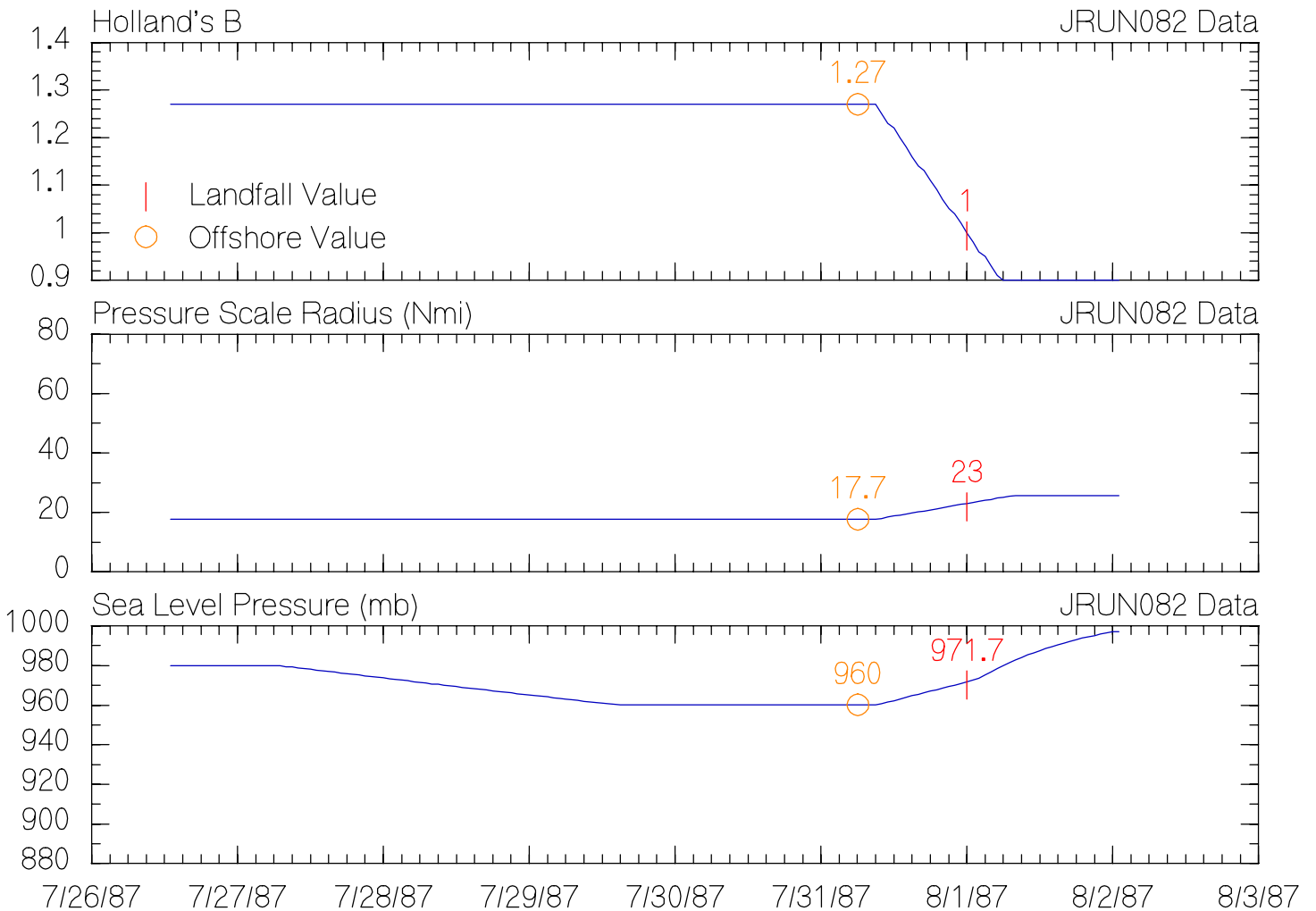
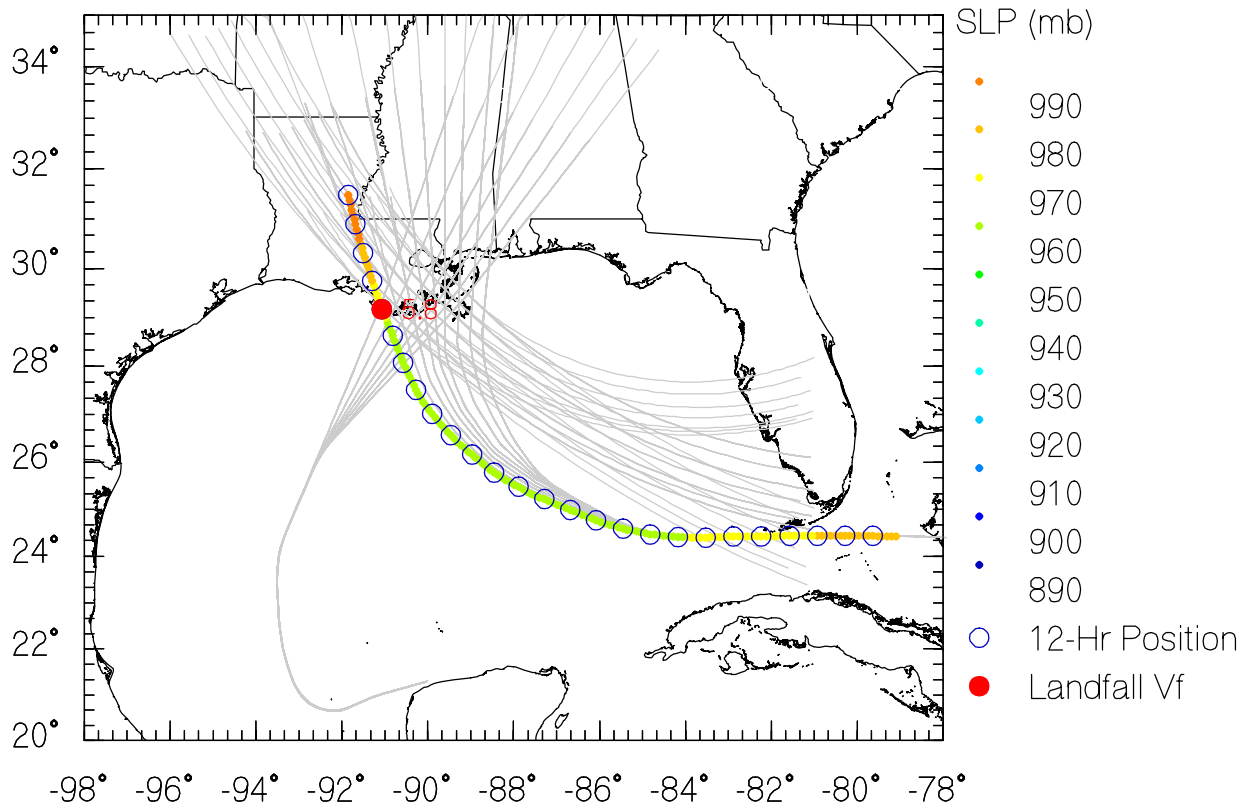

JRUN083 Data

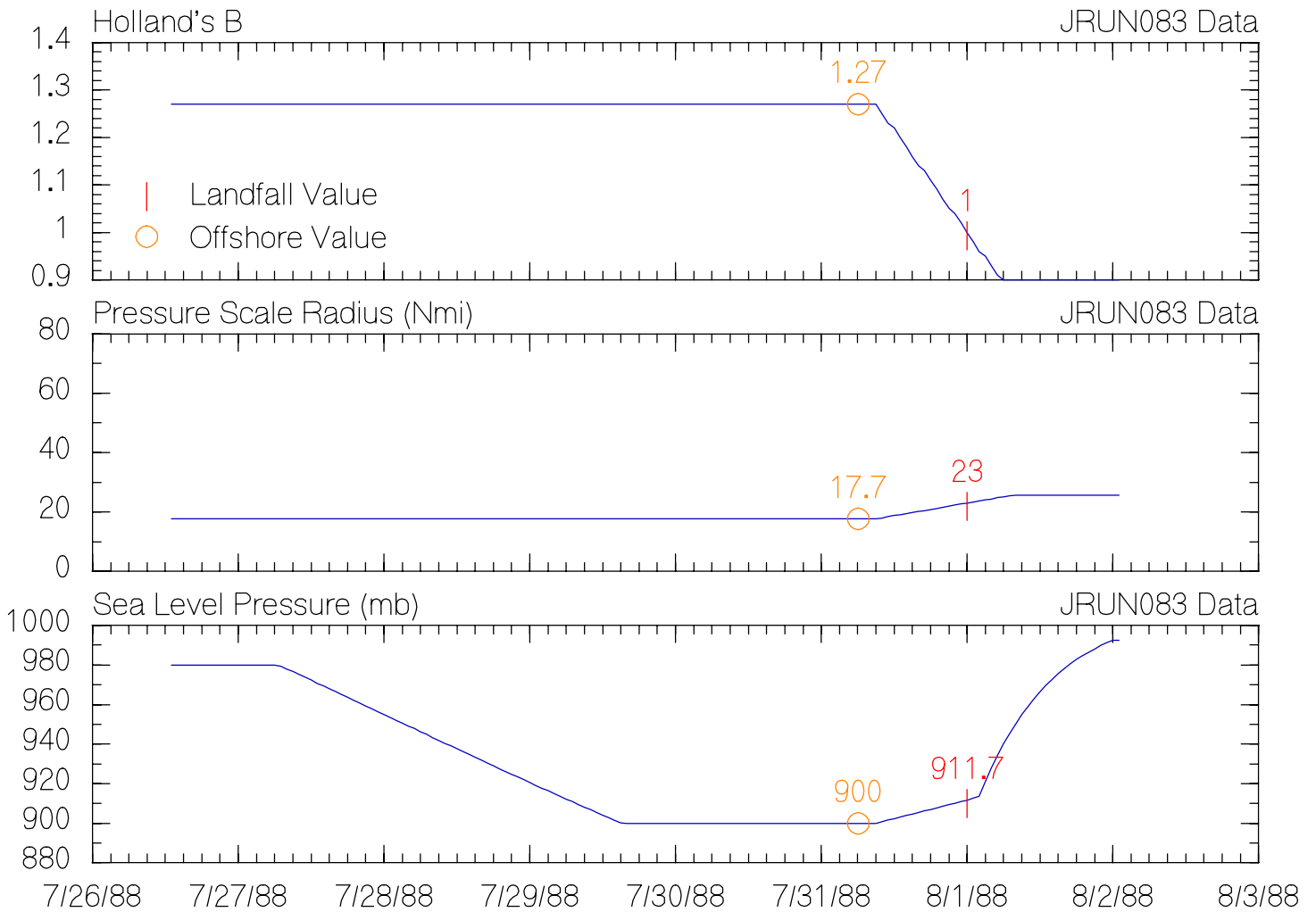
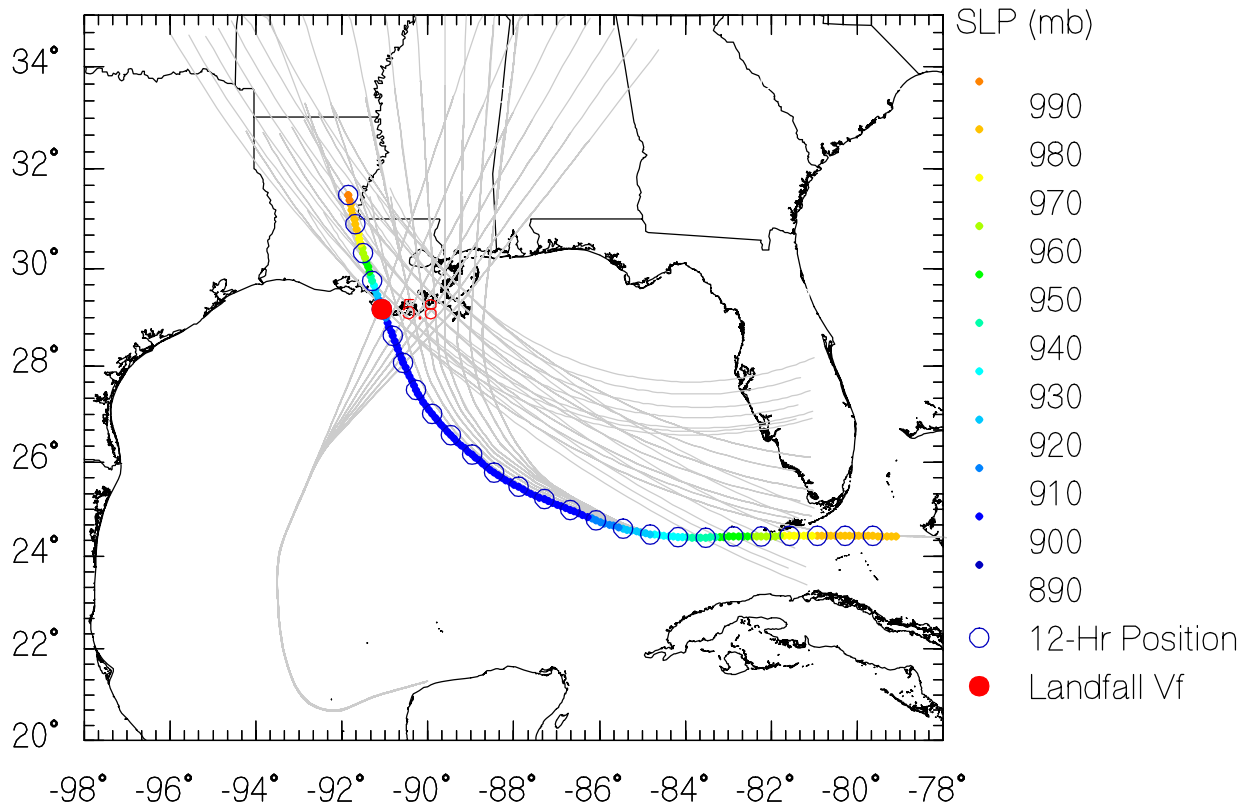

JRUN084 Data

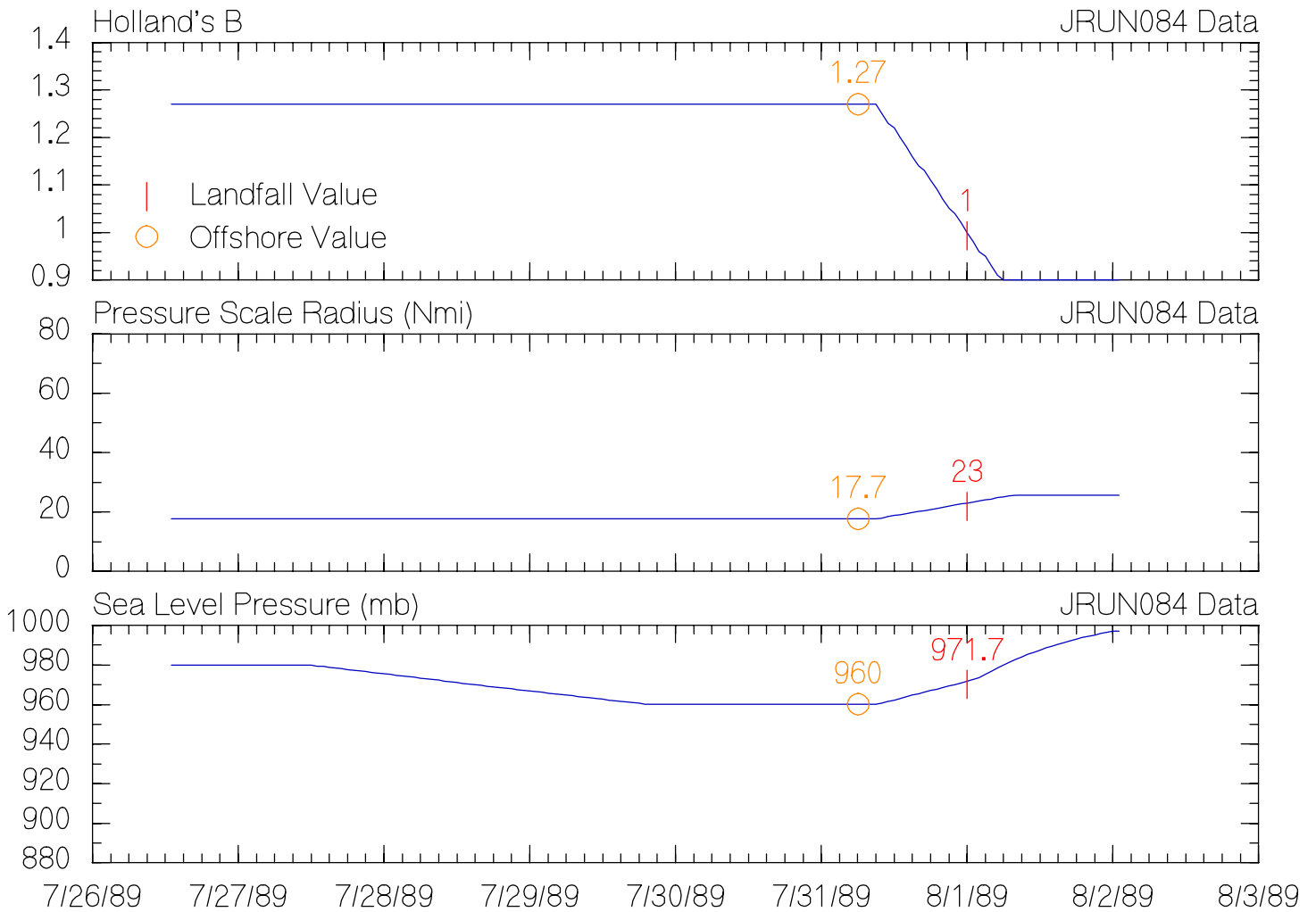
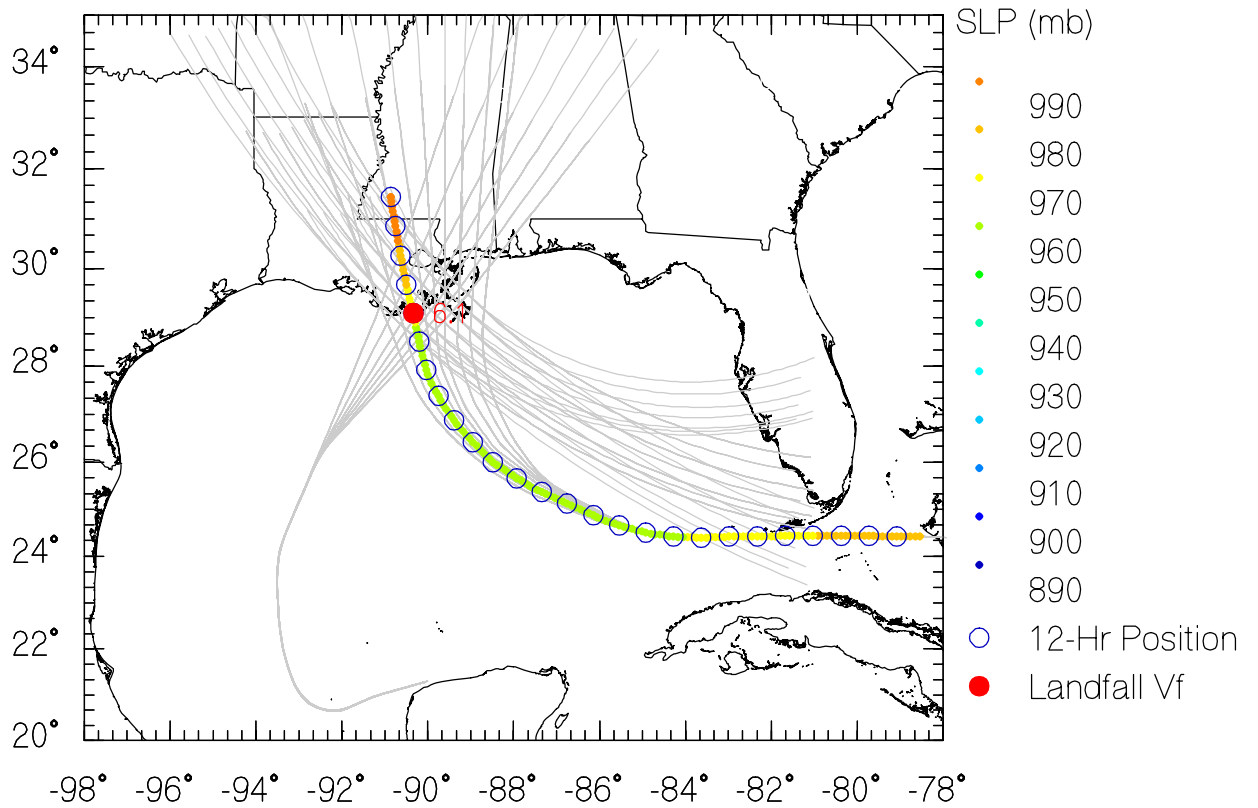

JRUN085 Data

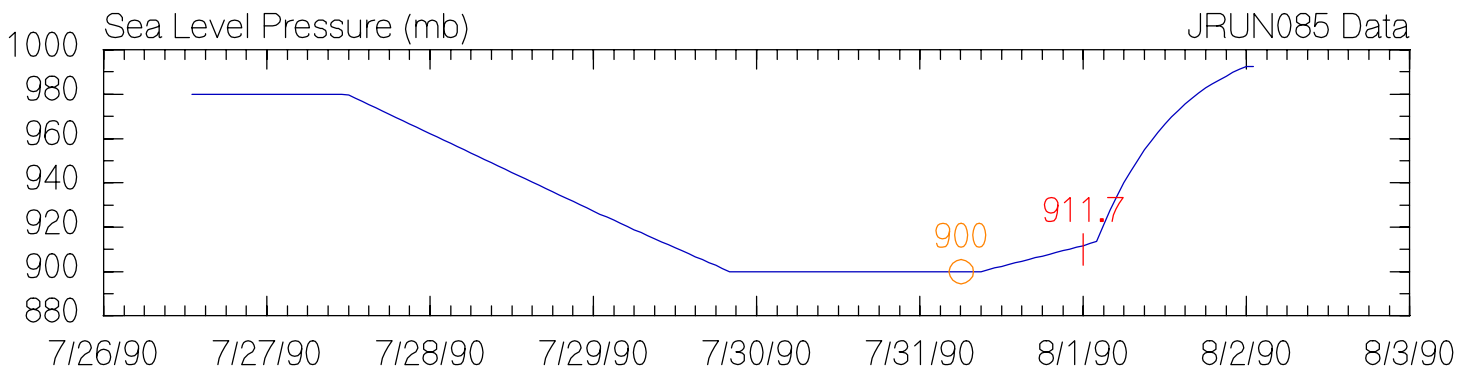
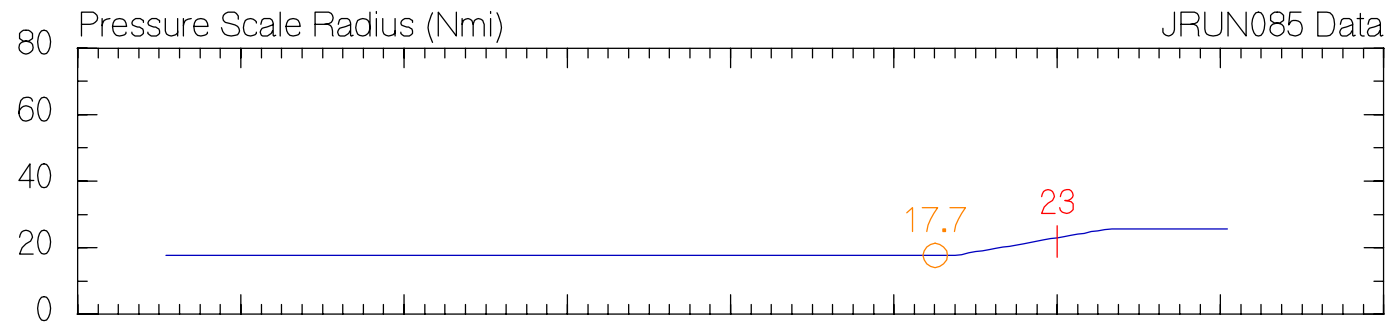
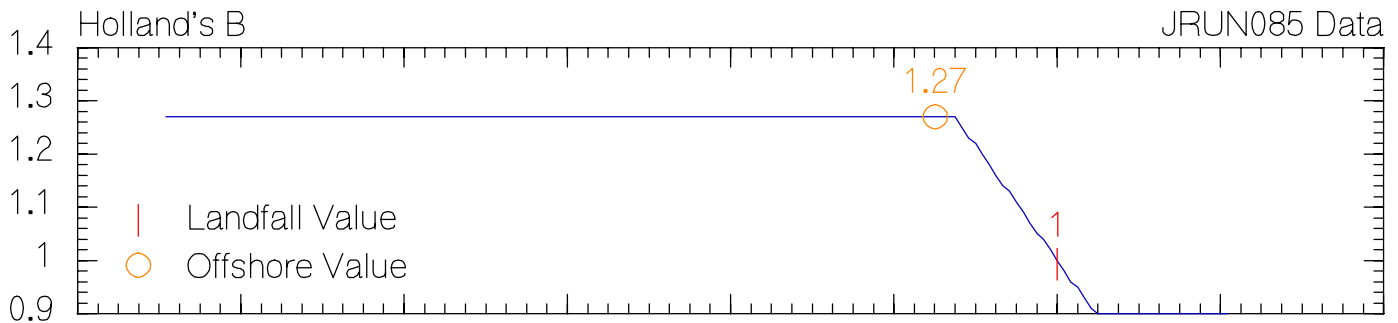
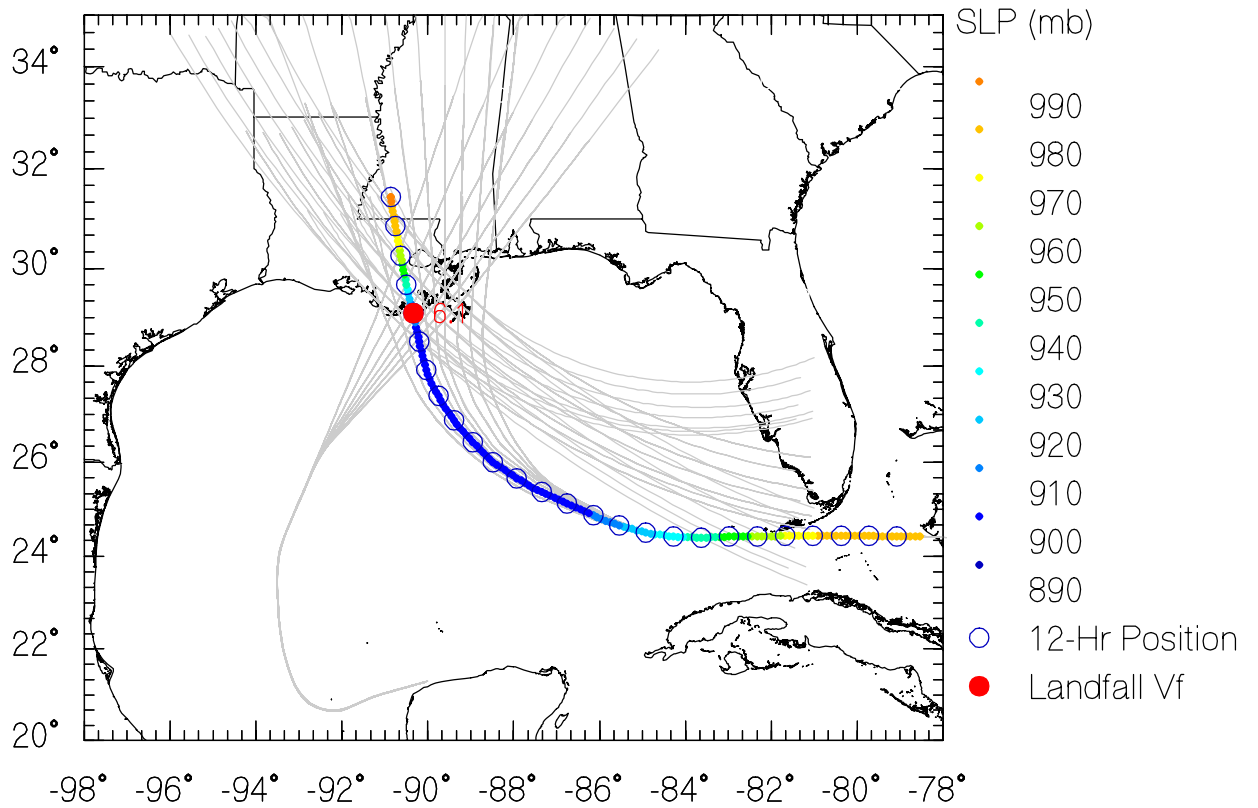

JRUN086 Data

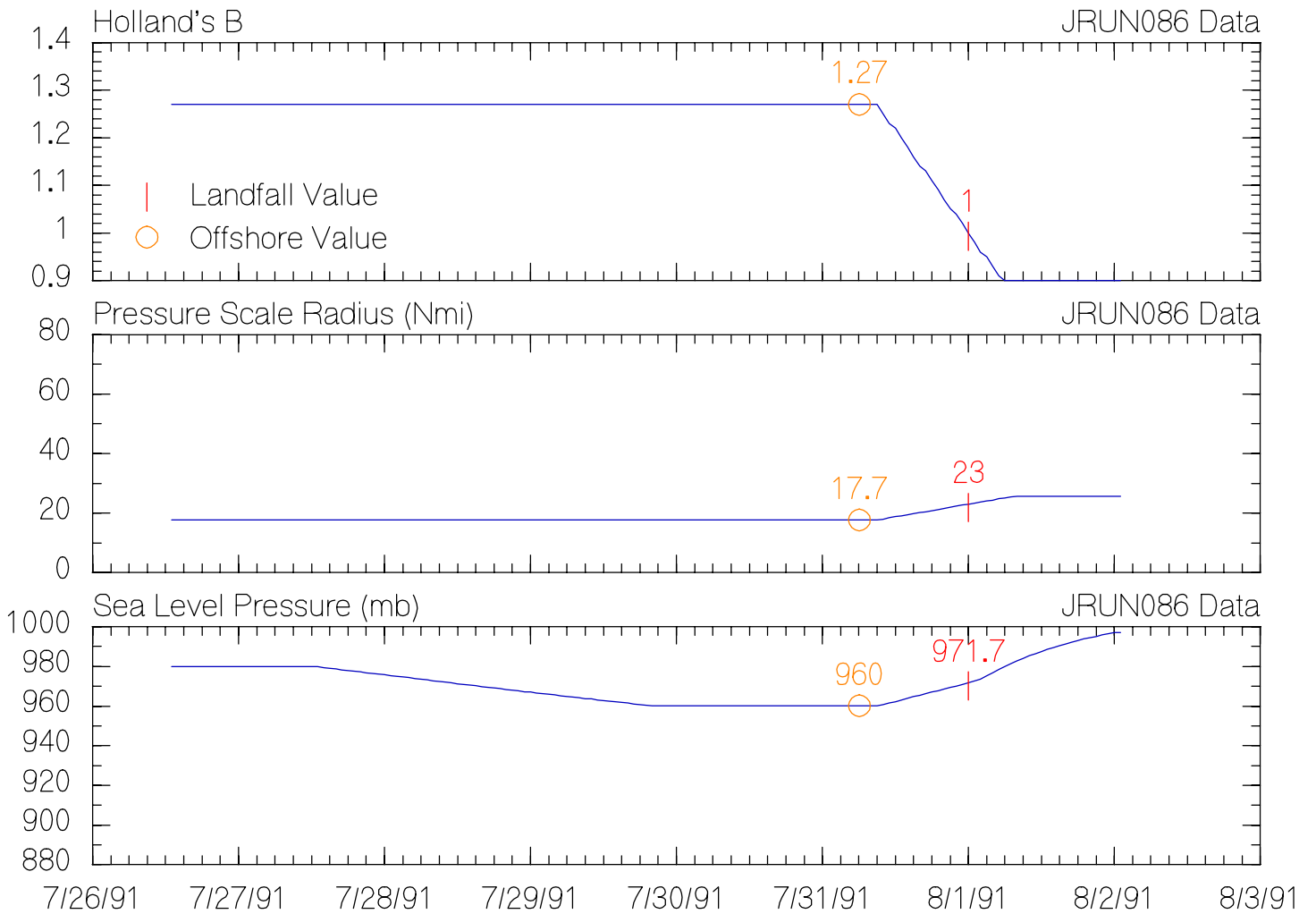
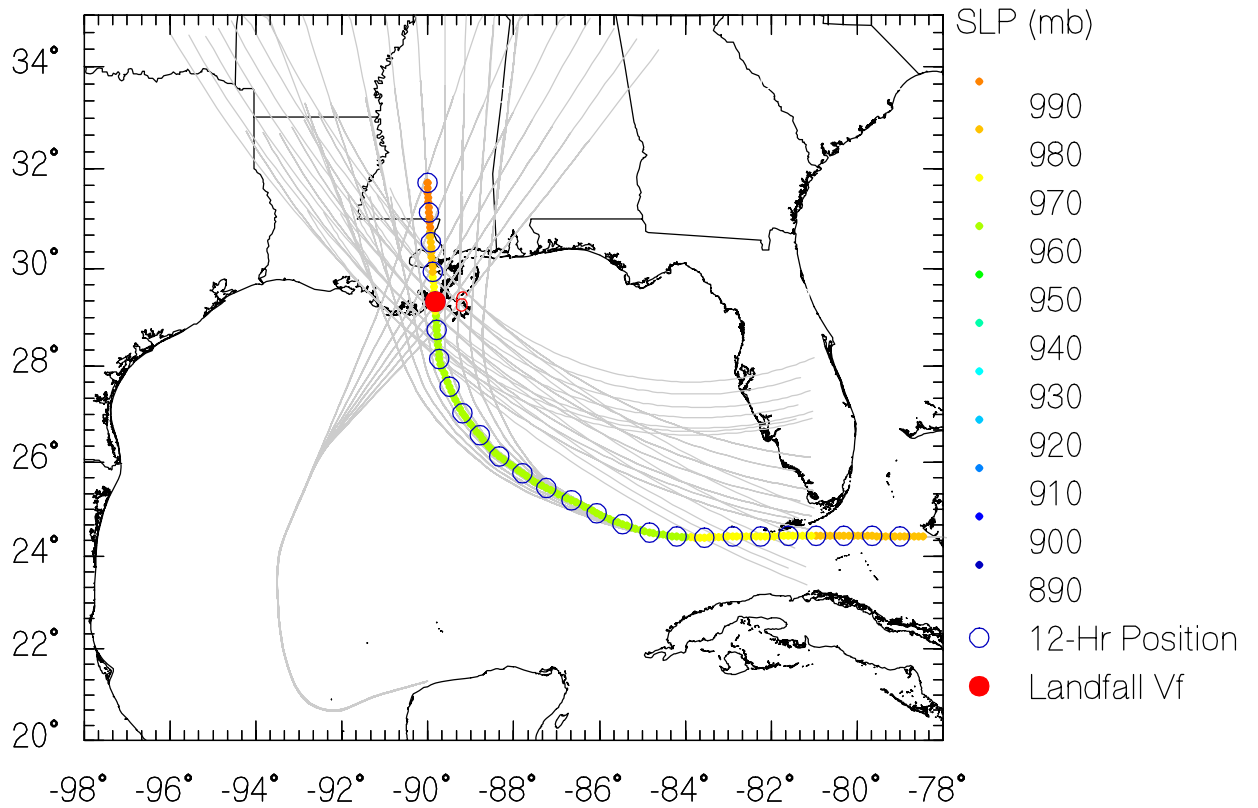

JRUN087 Data

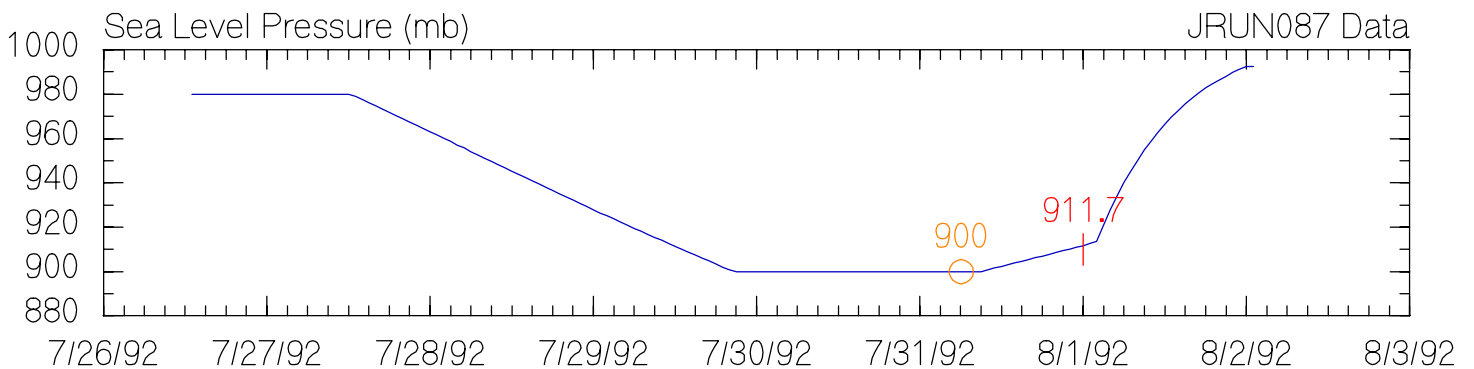
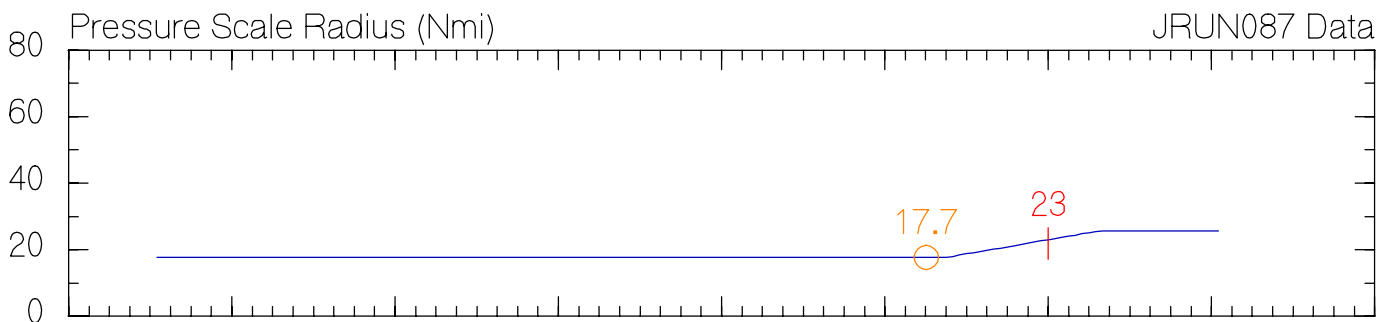
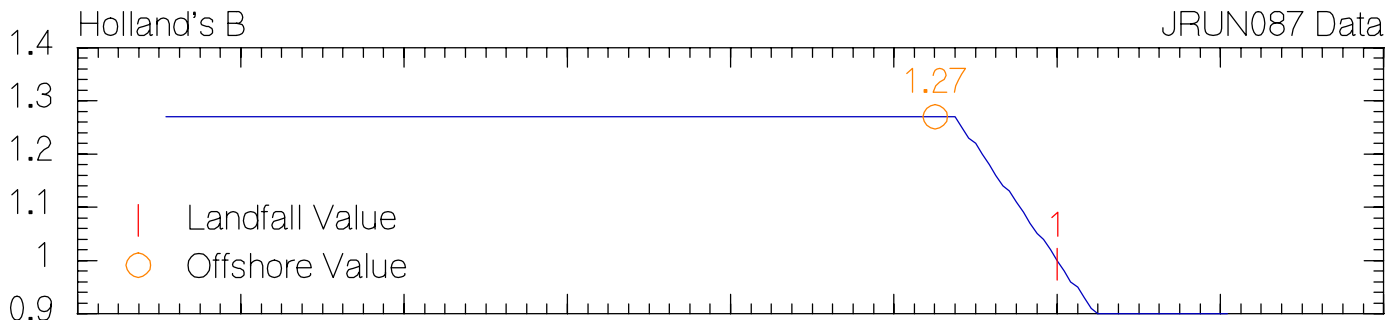
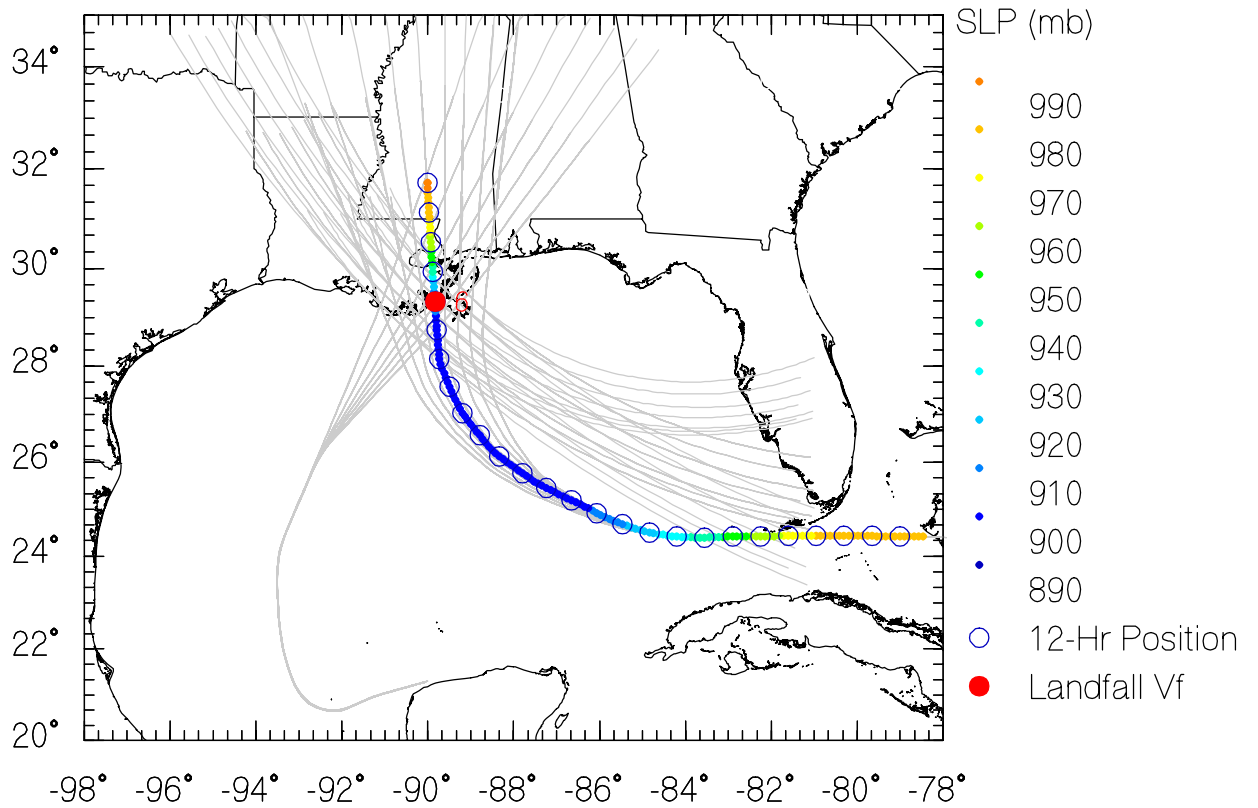

JRUN088 Data

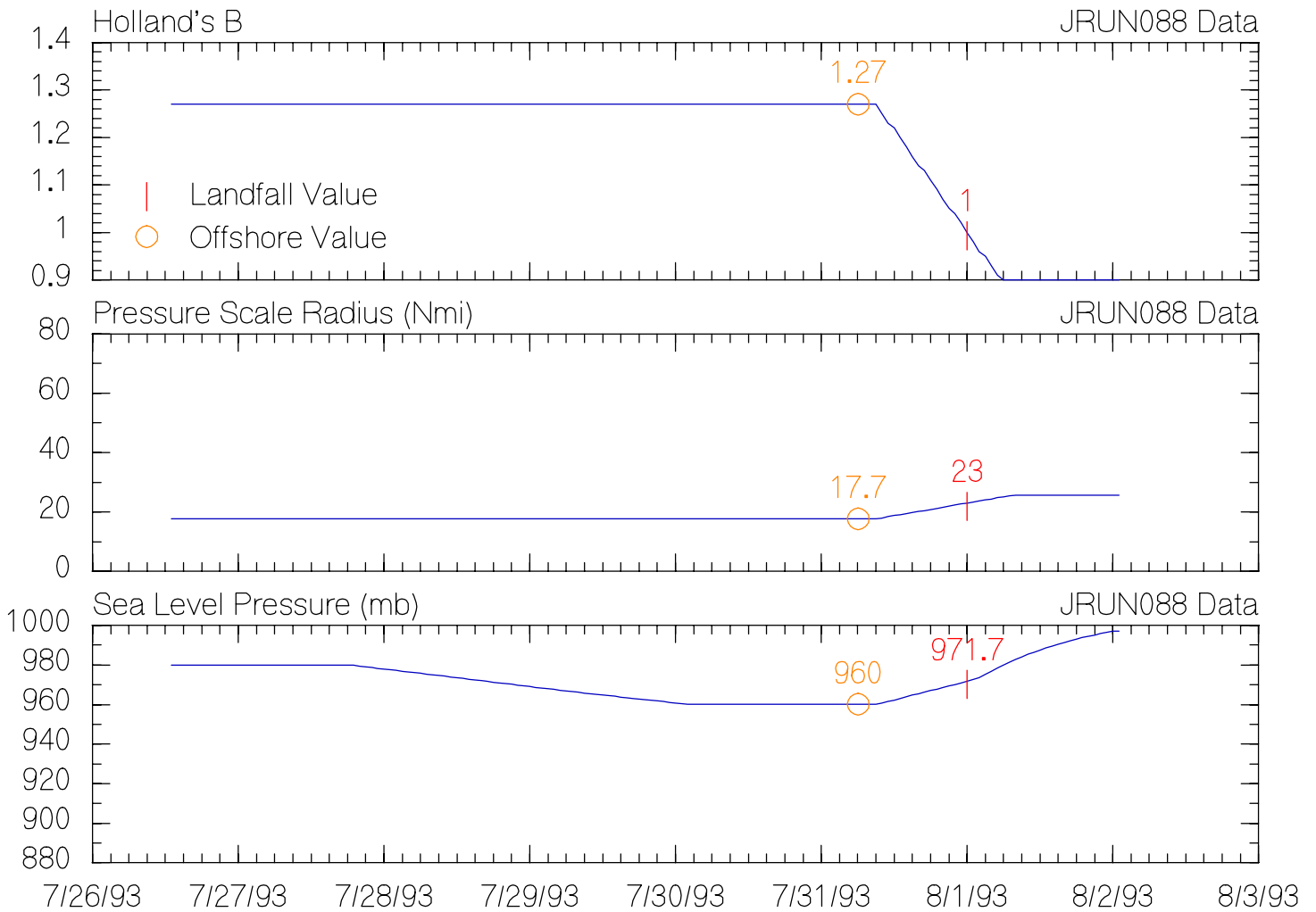
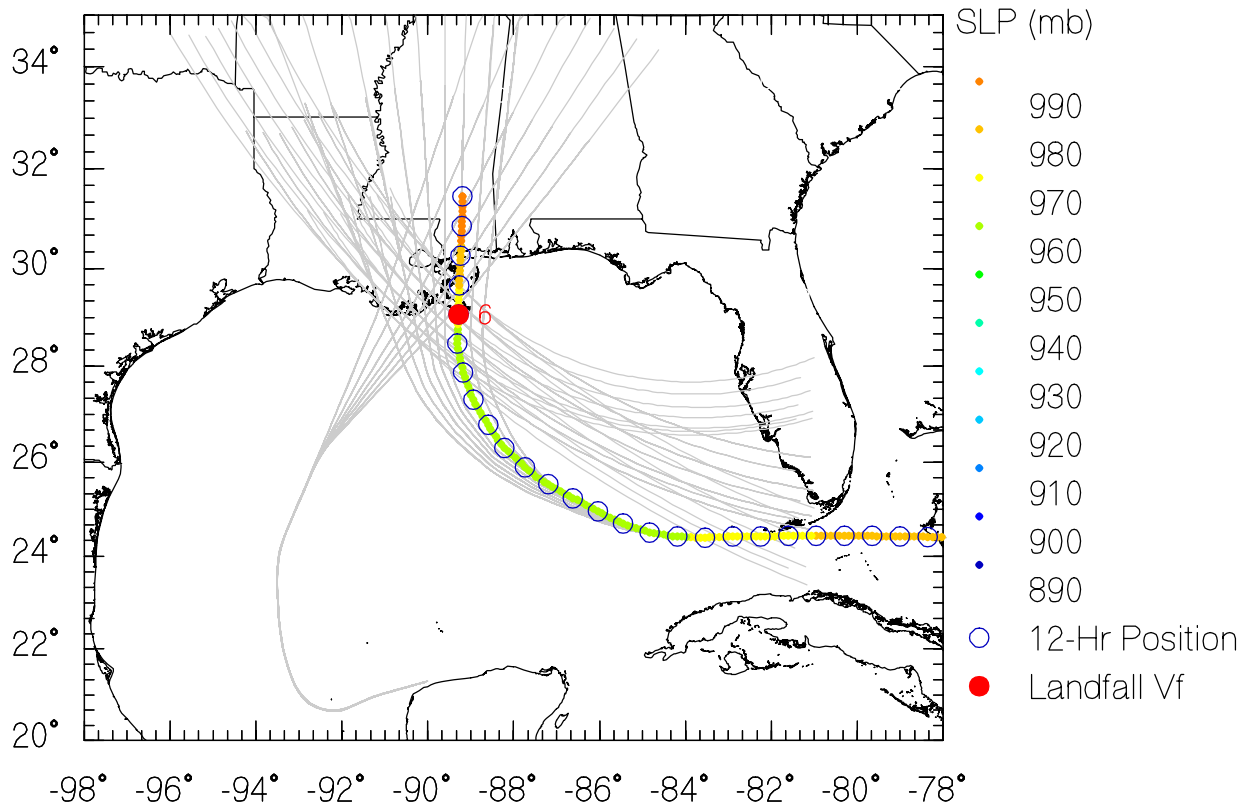

JRUN089 Data

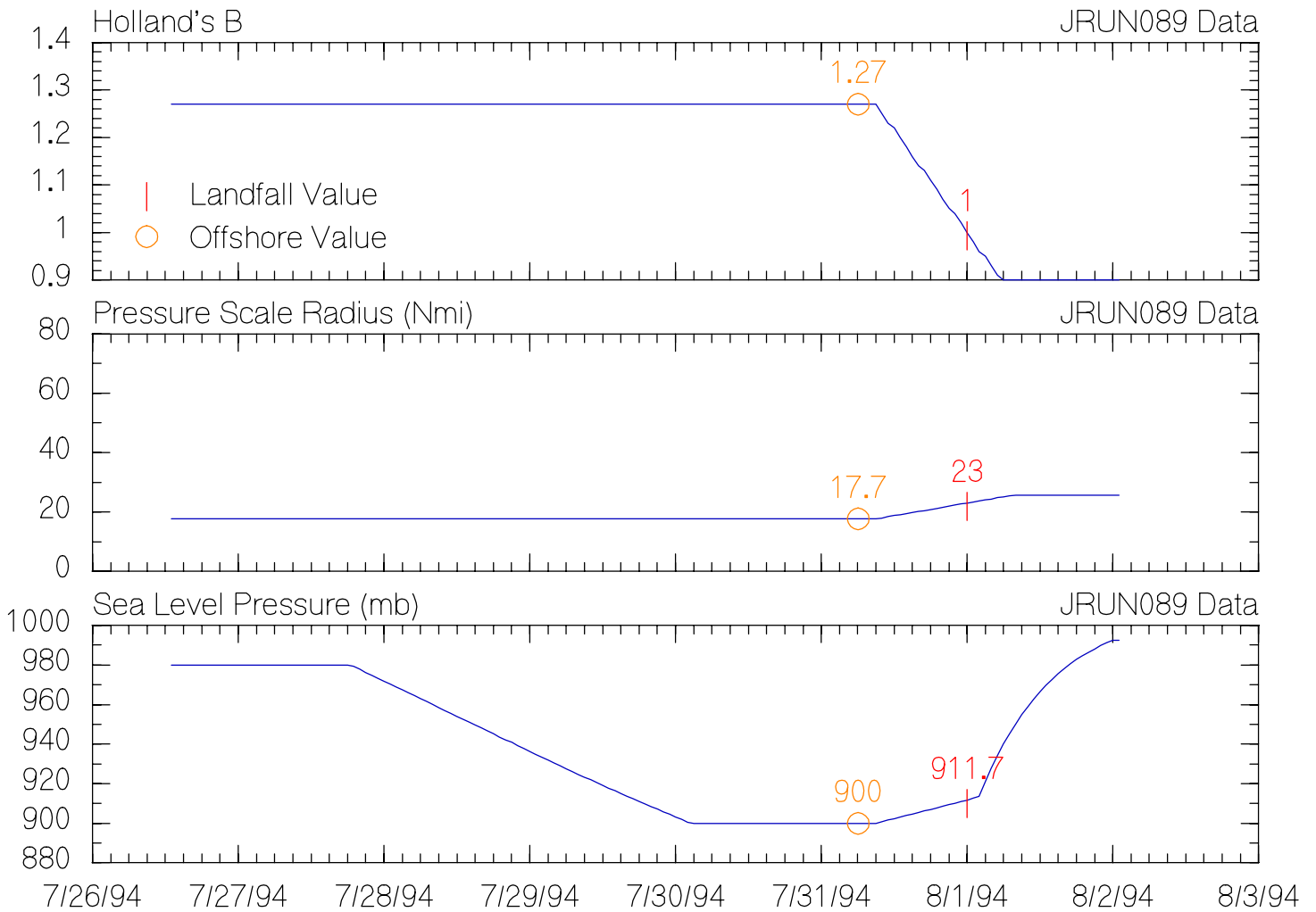
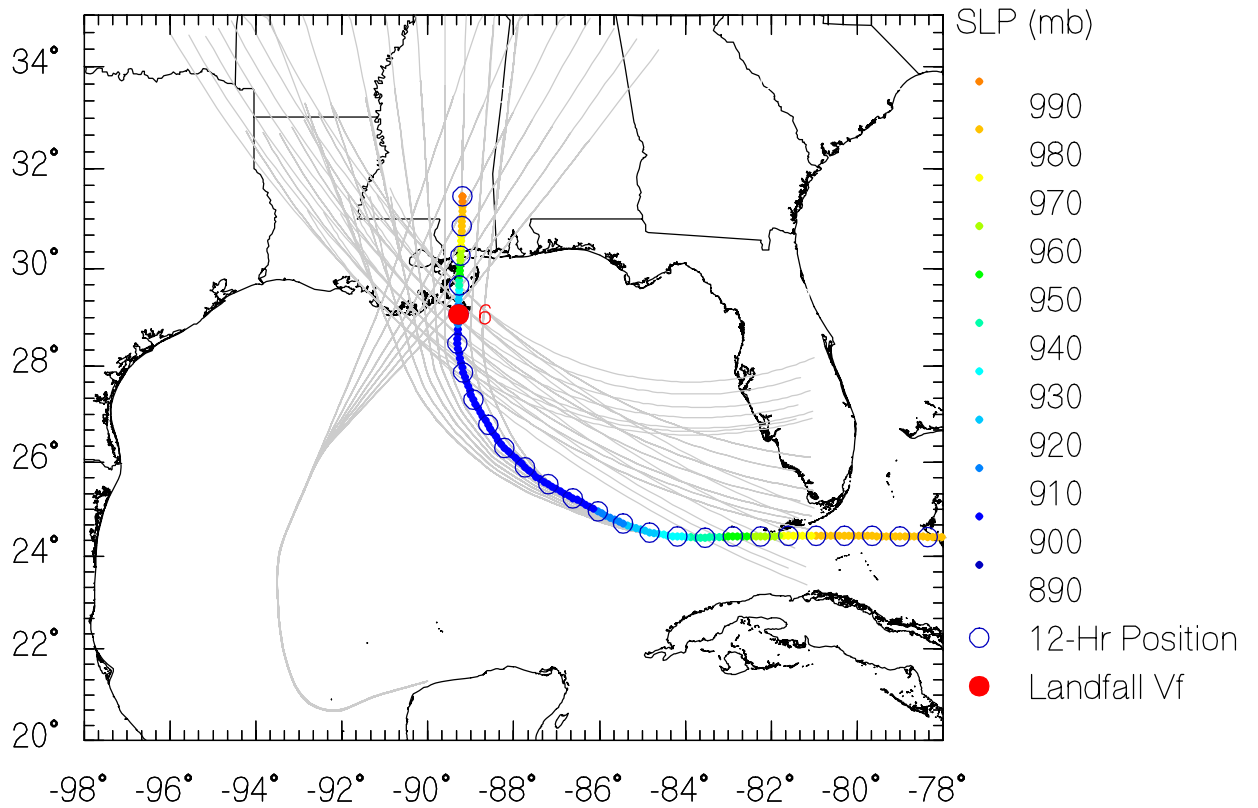

JRUN090 Data

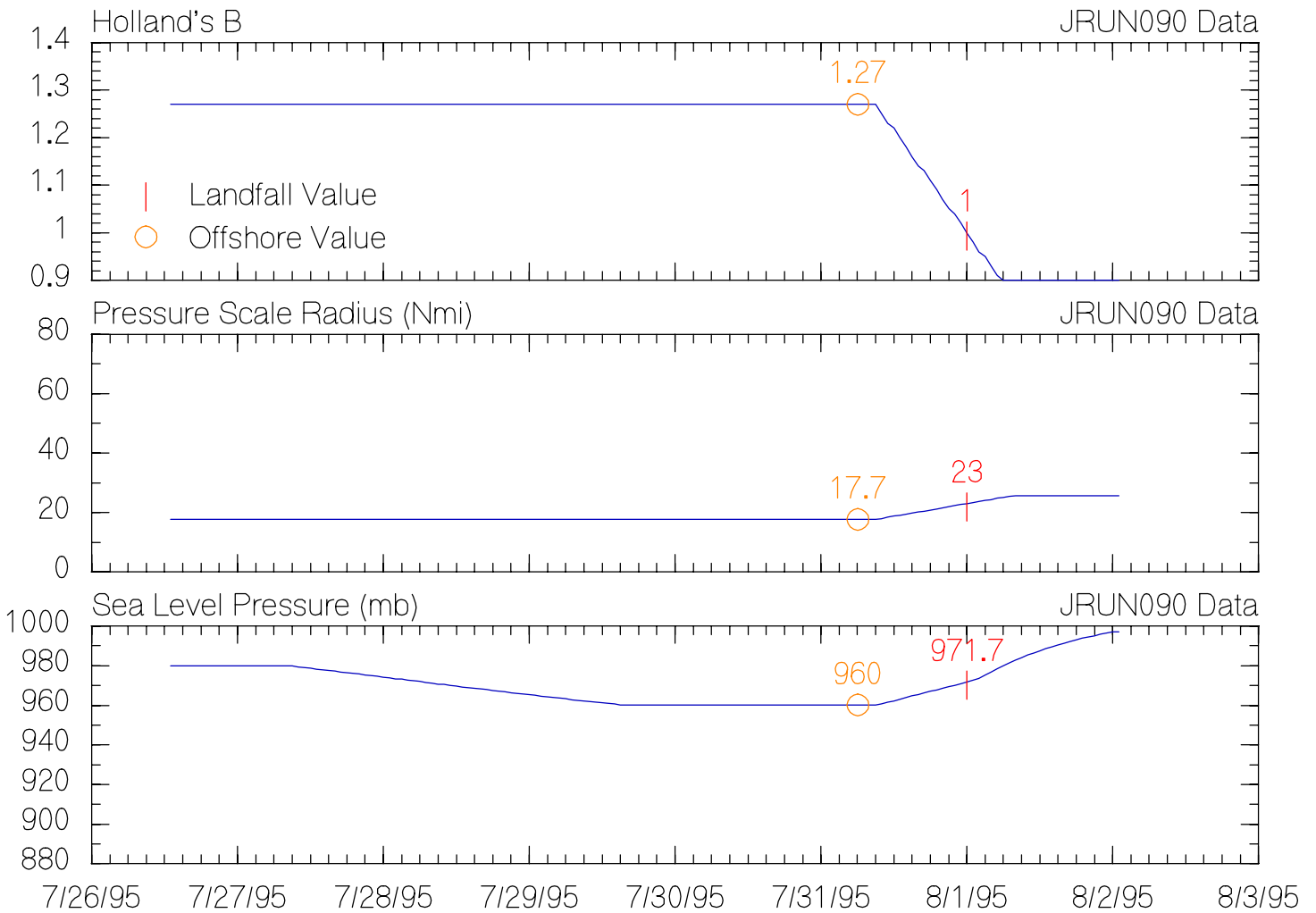
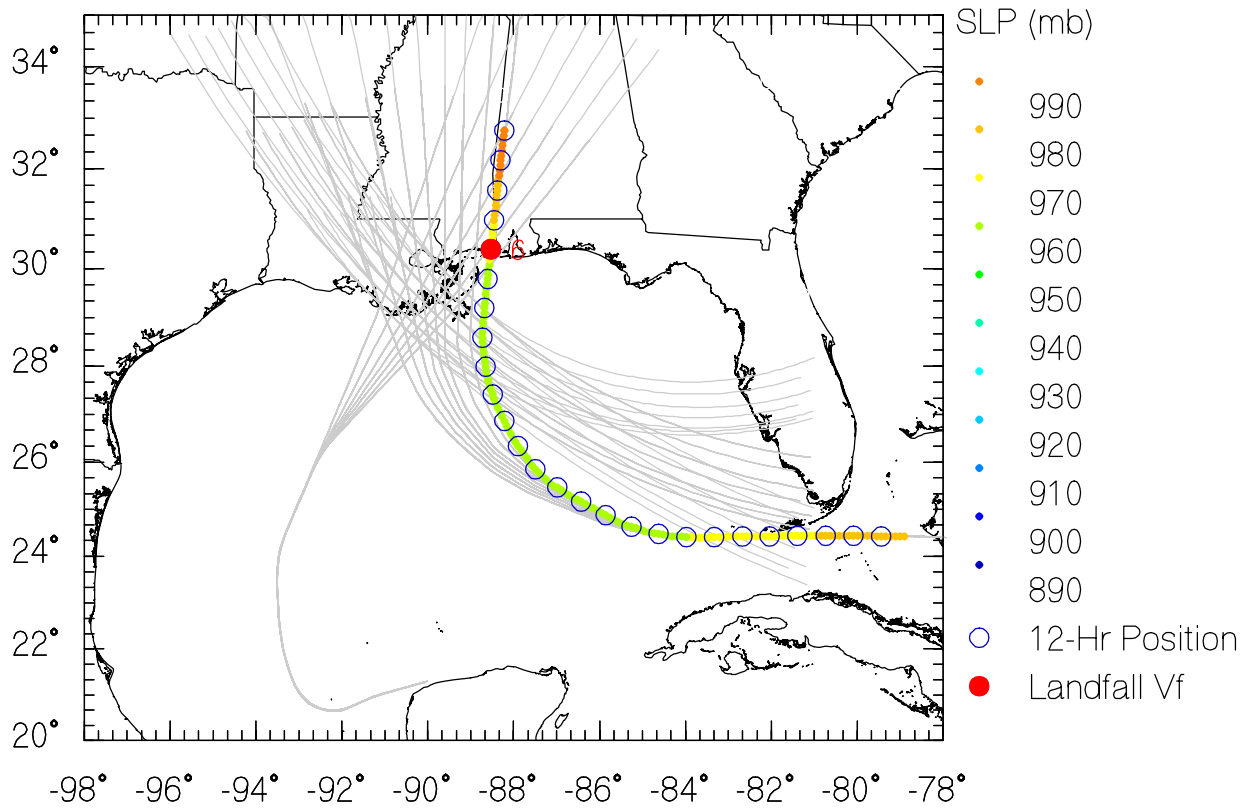

JRUN091 Data

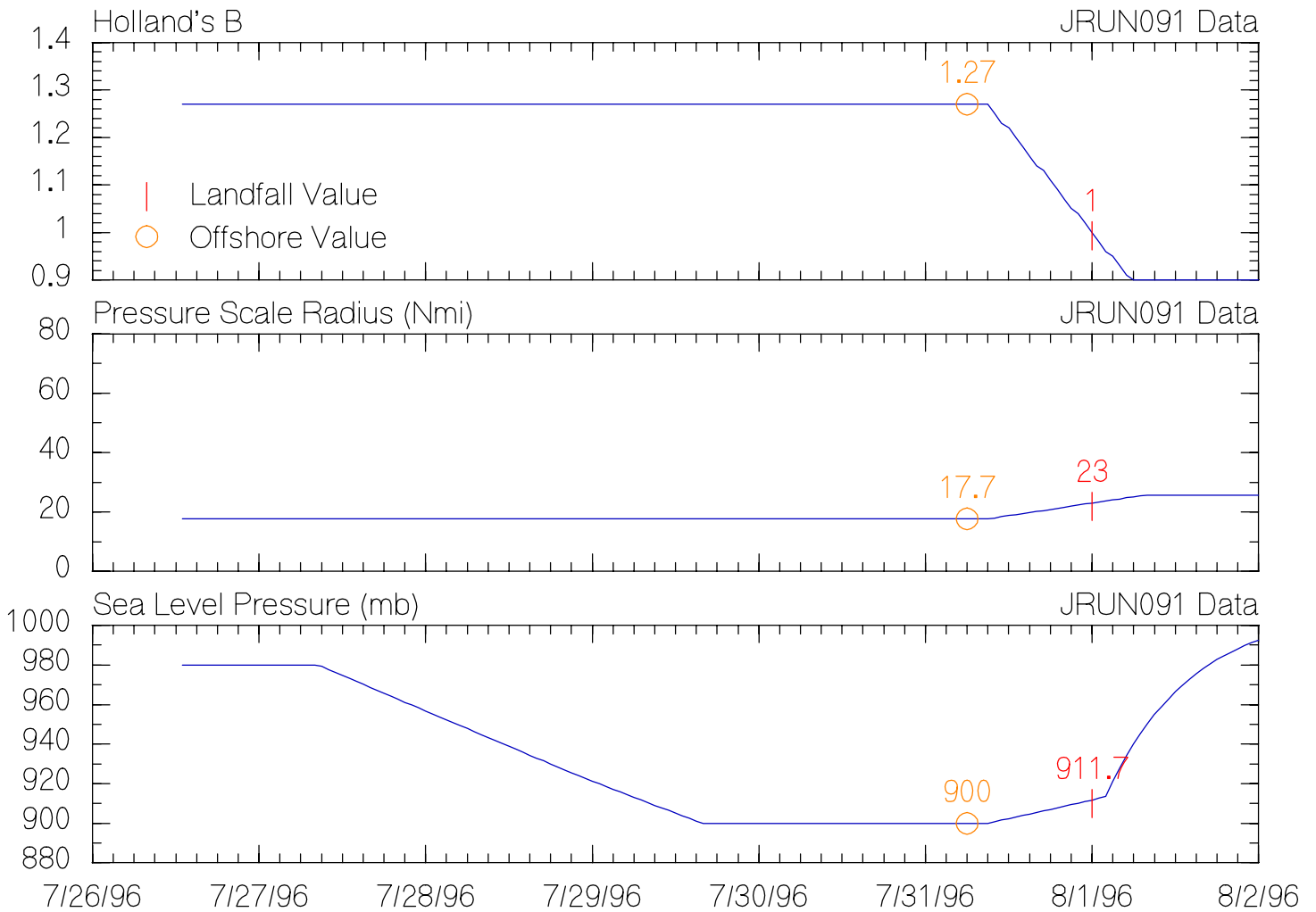
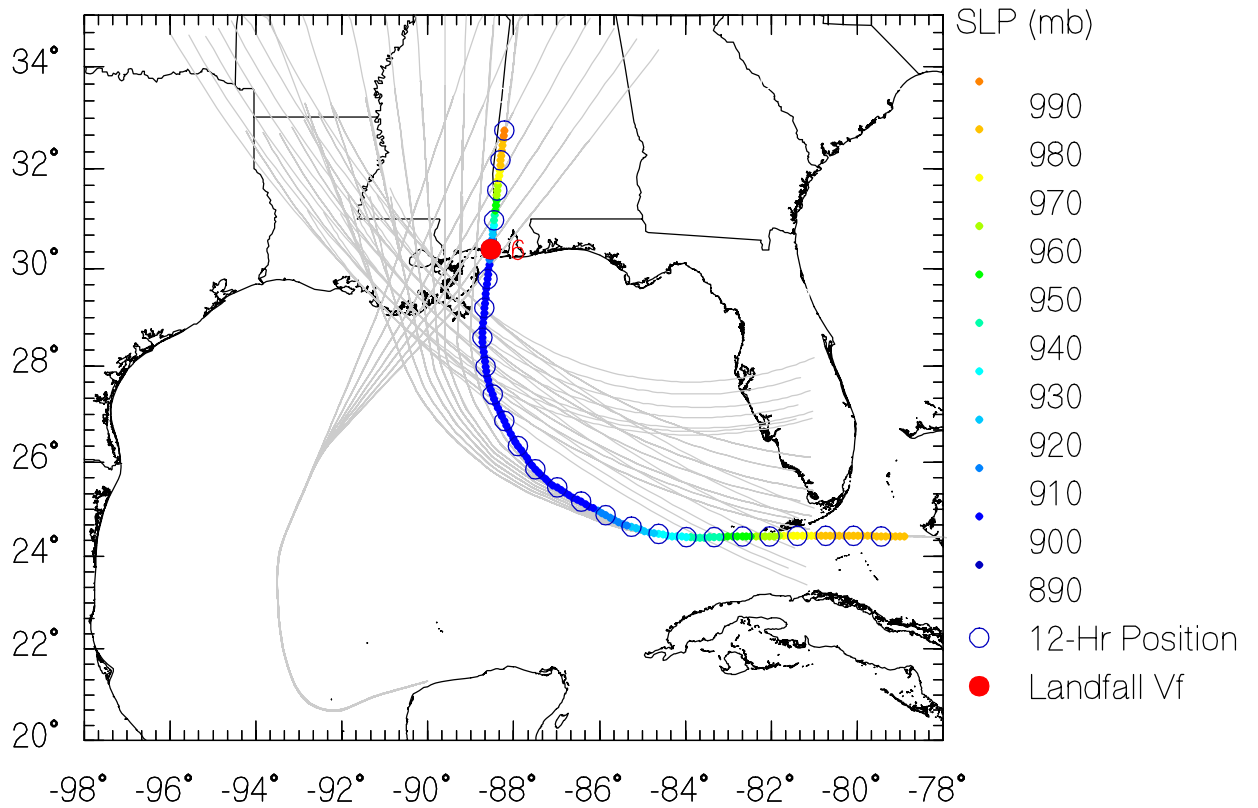

JRUN092 Data

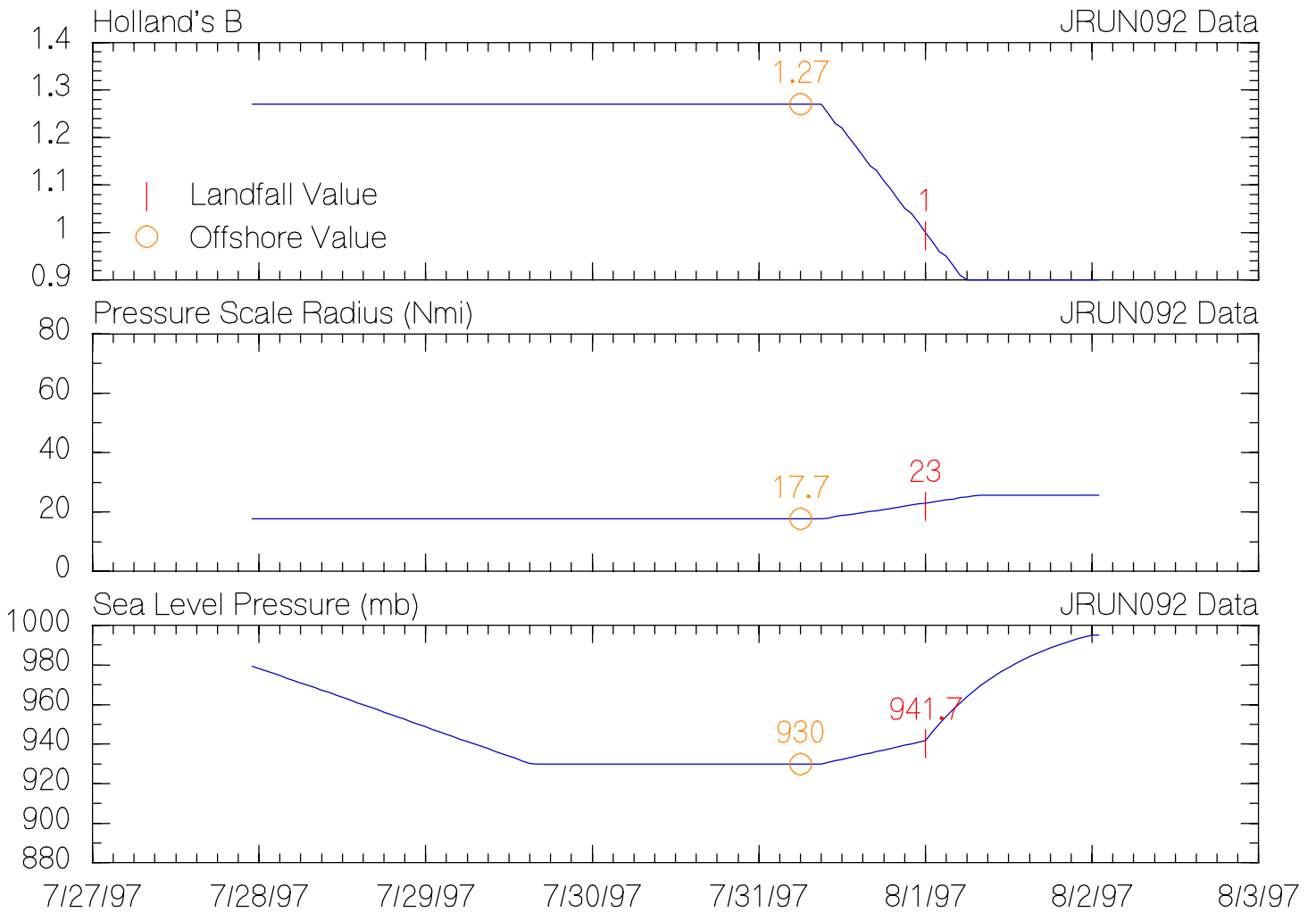
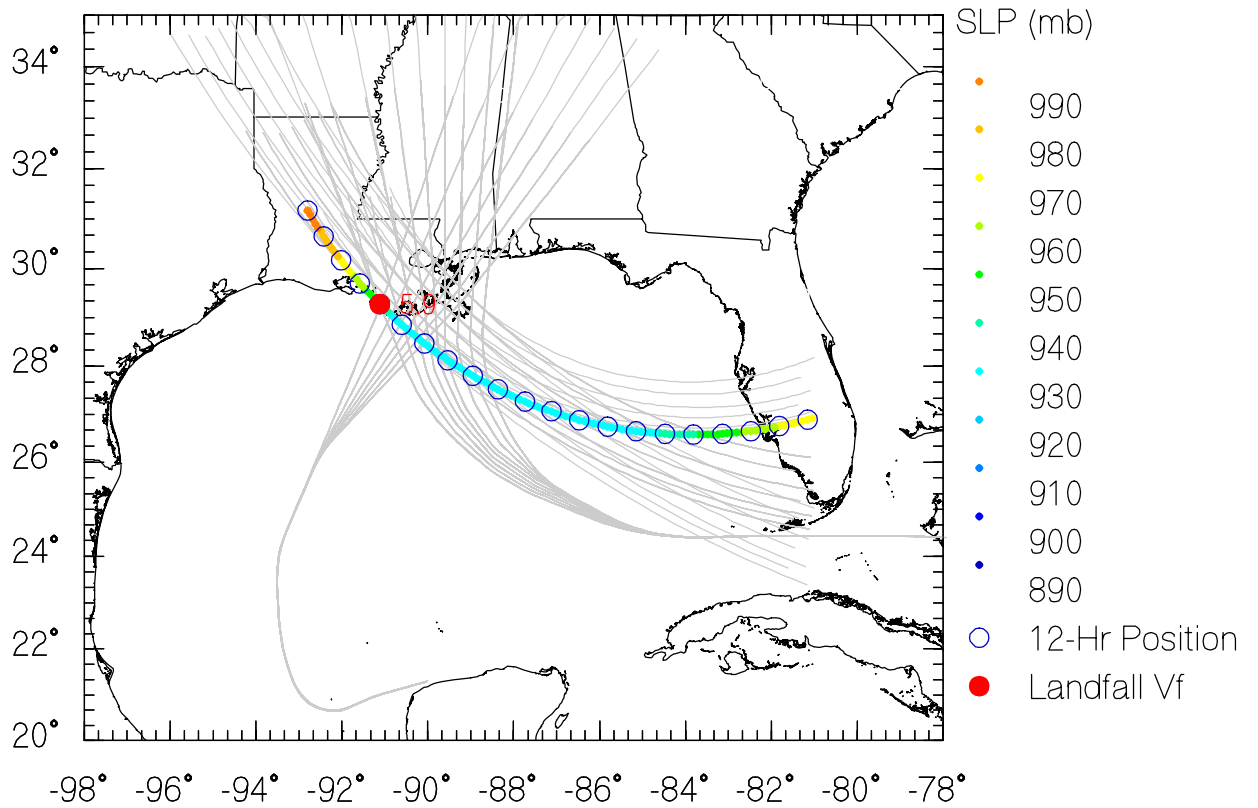

JRUN093 Data

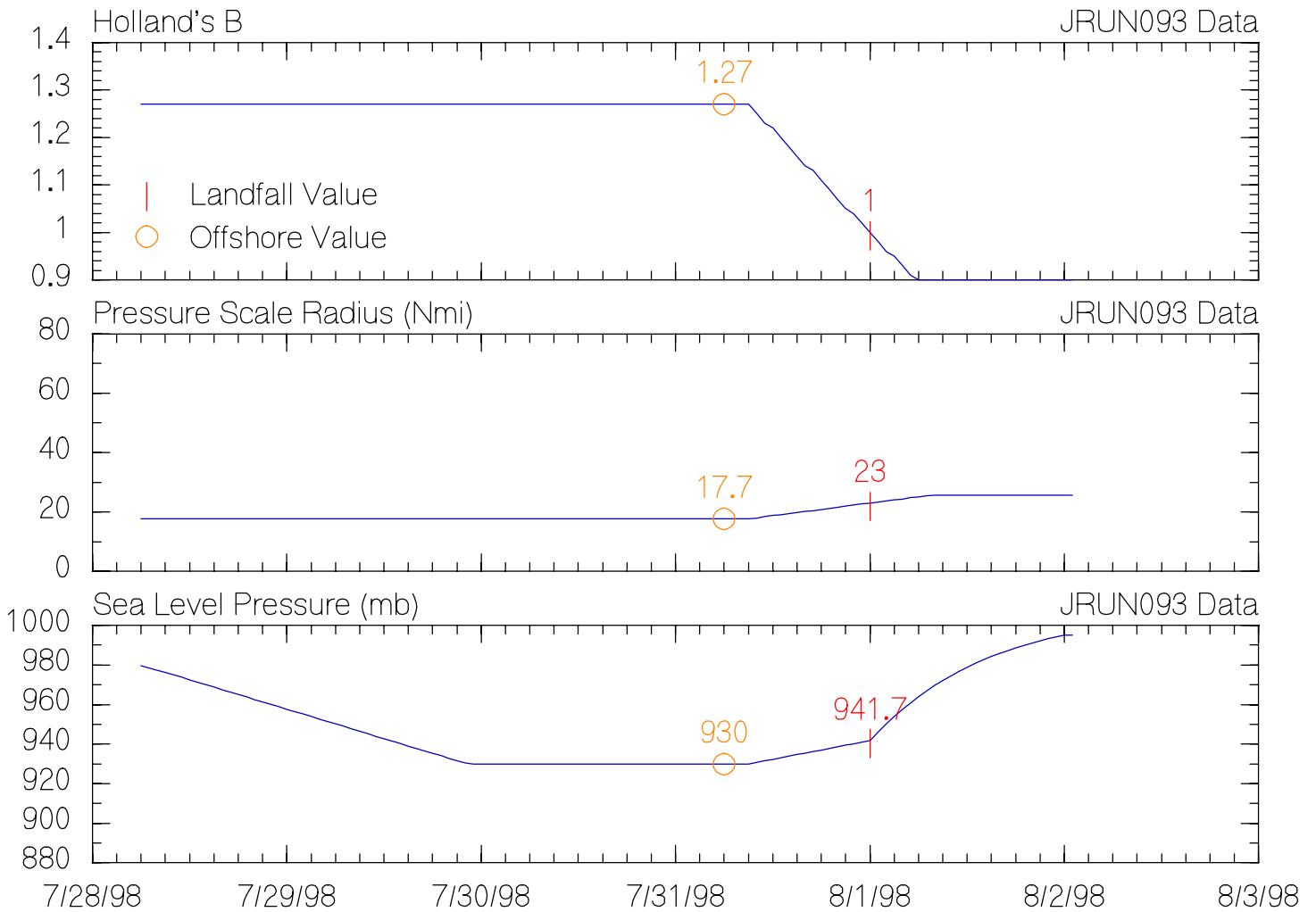
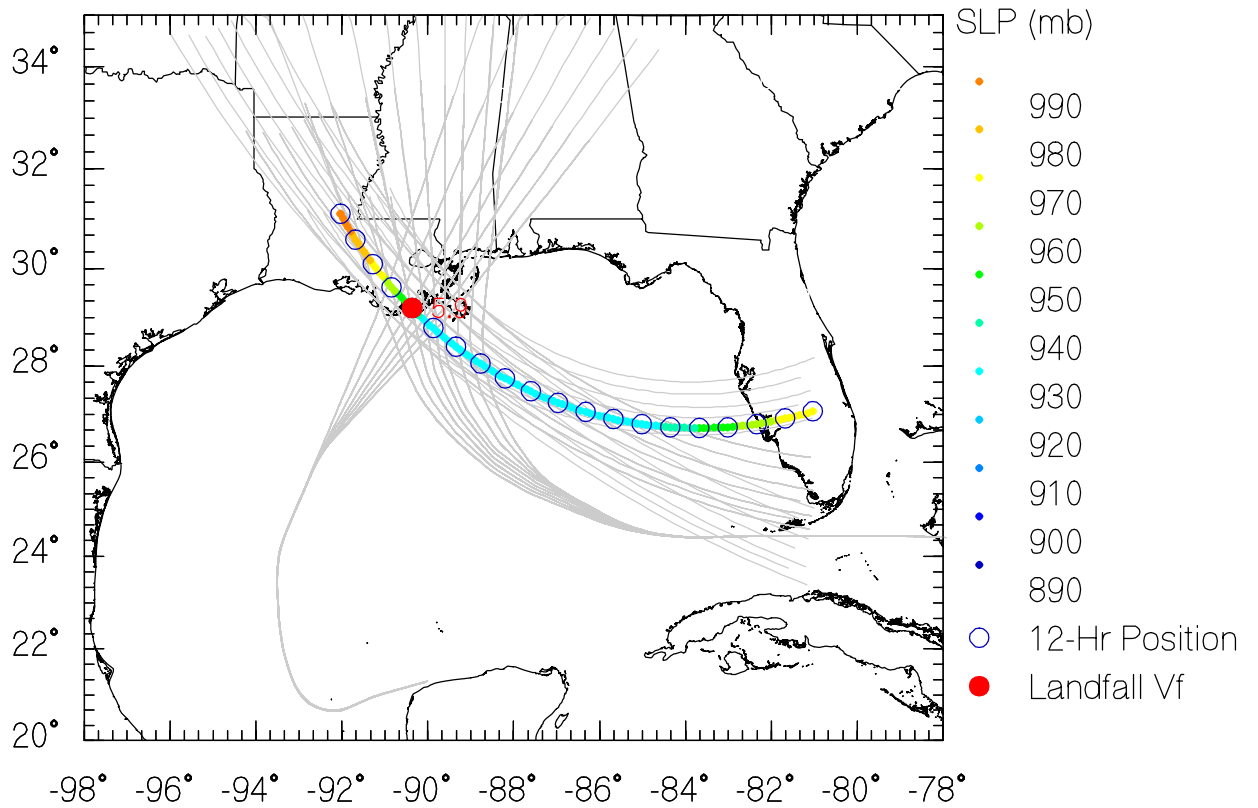

JRUN094 Data

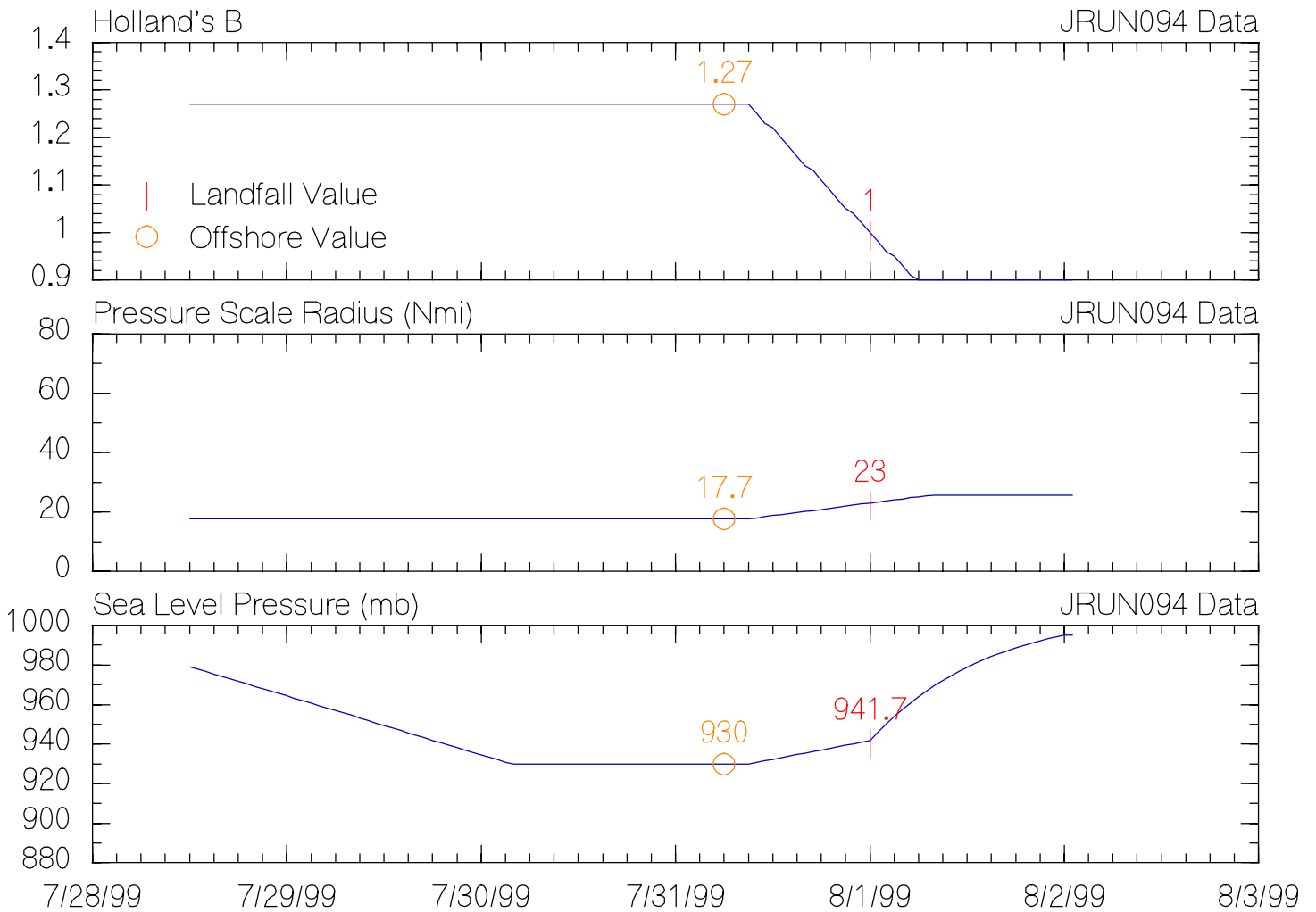
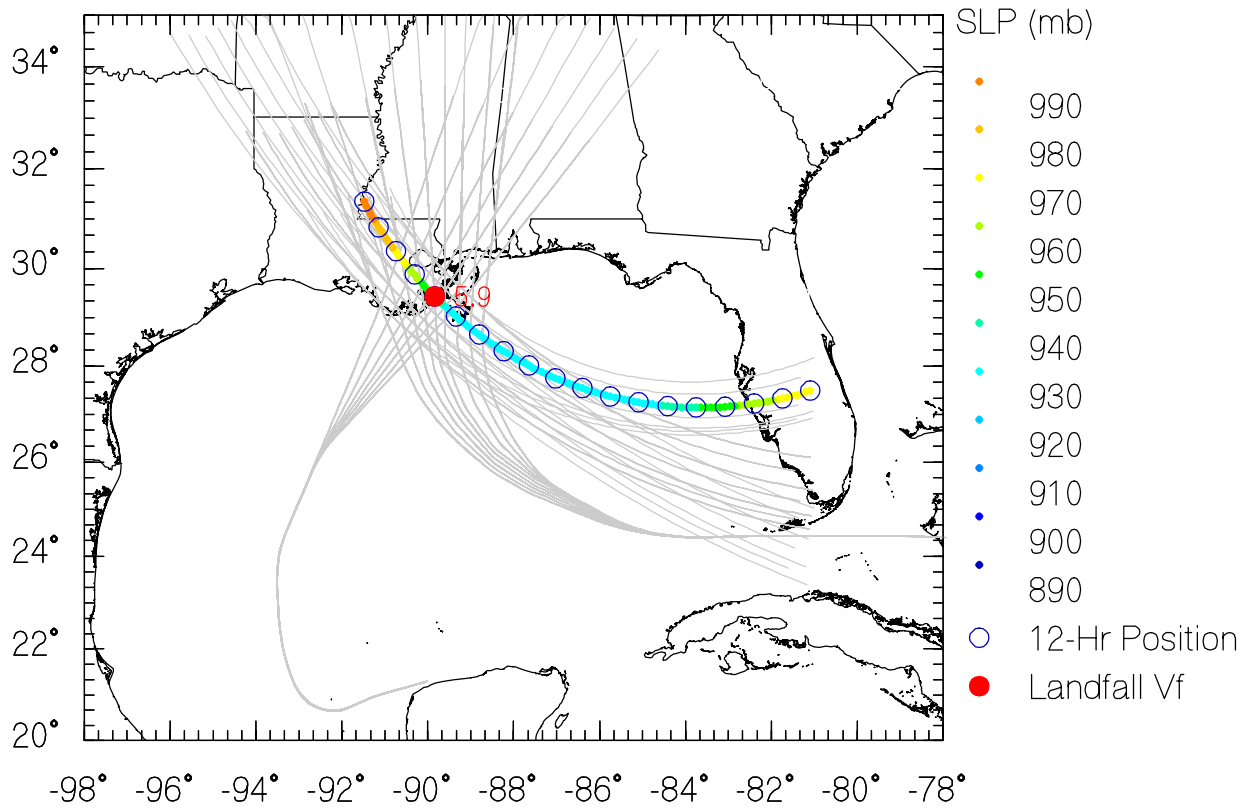

JRUN095 Data

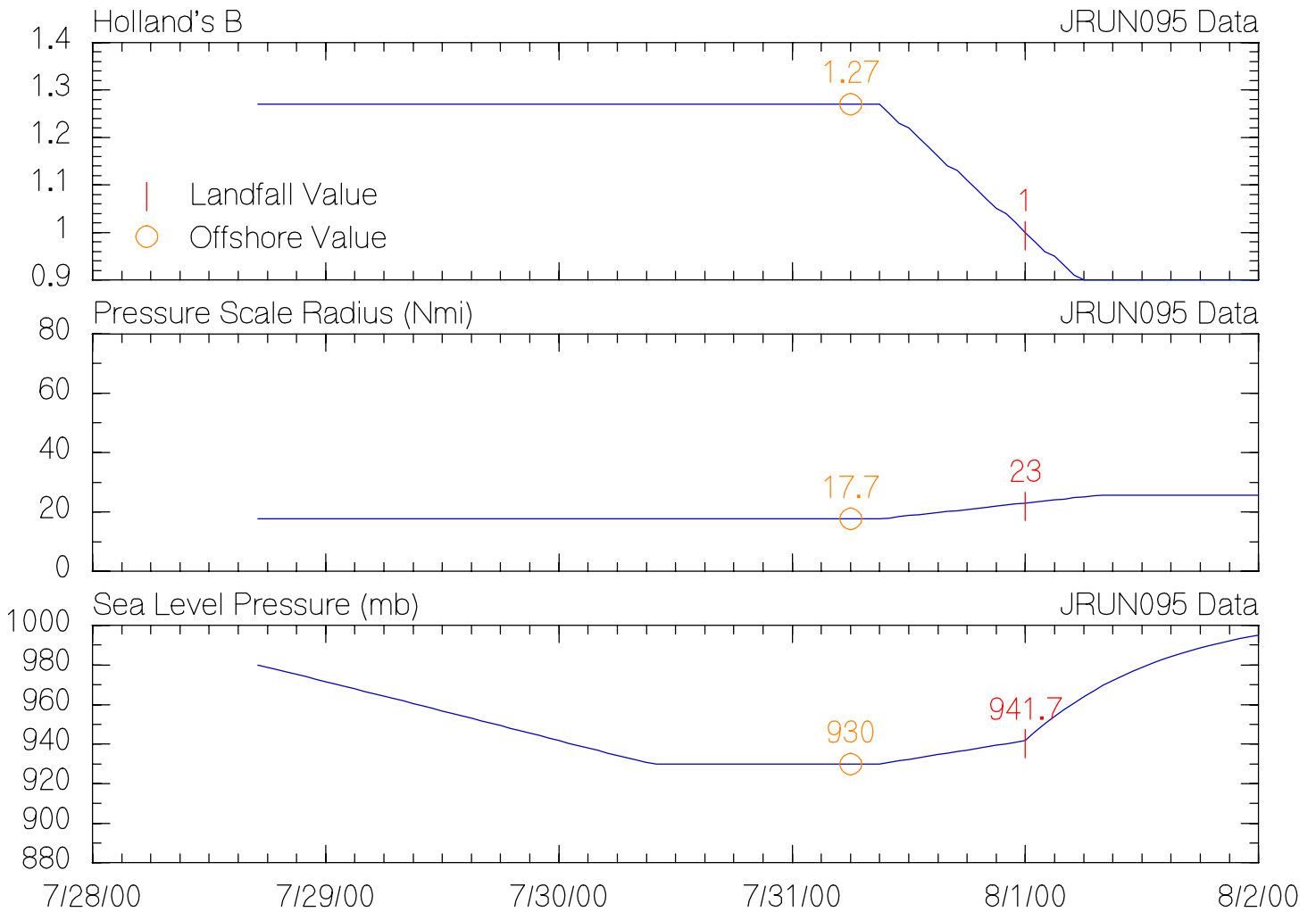
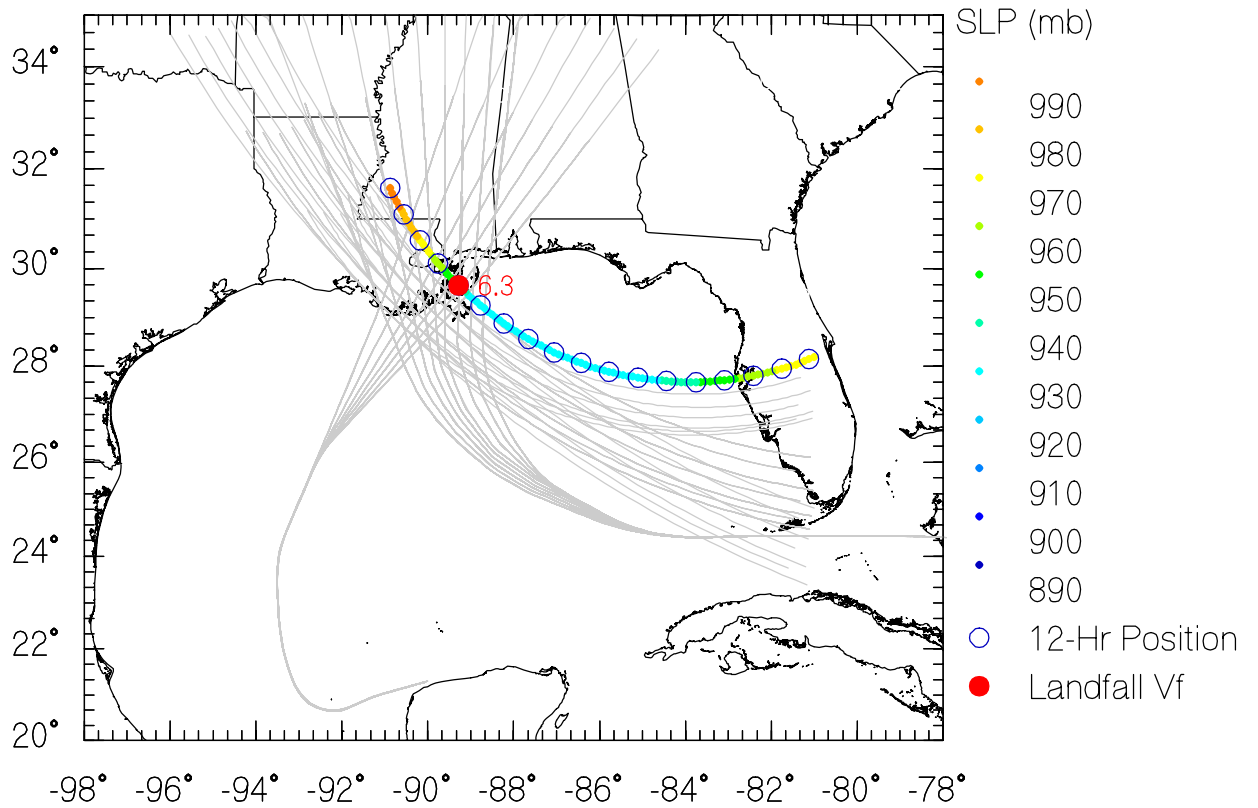

JRUN097 Data

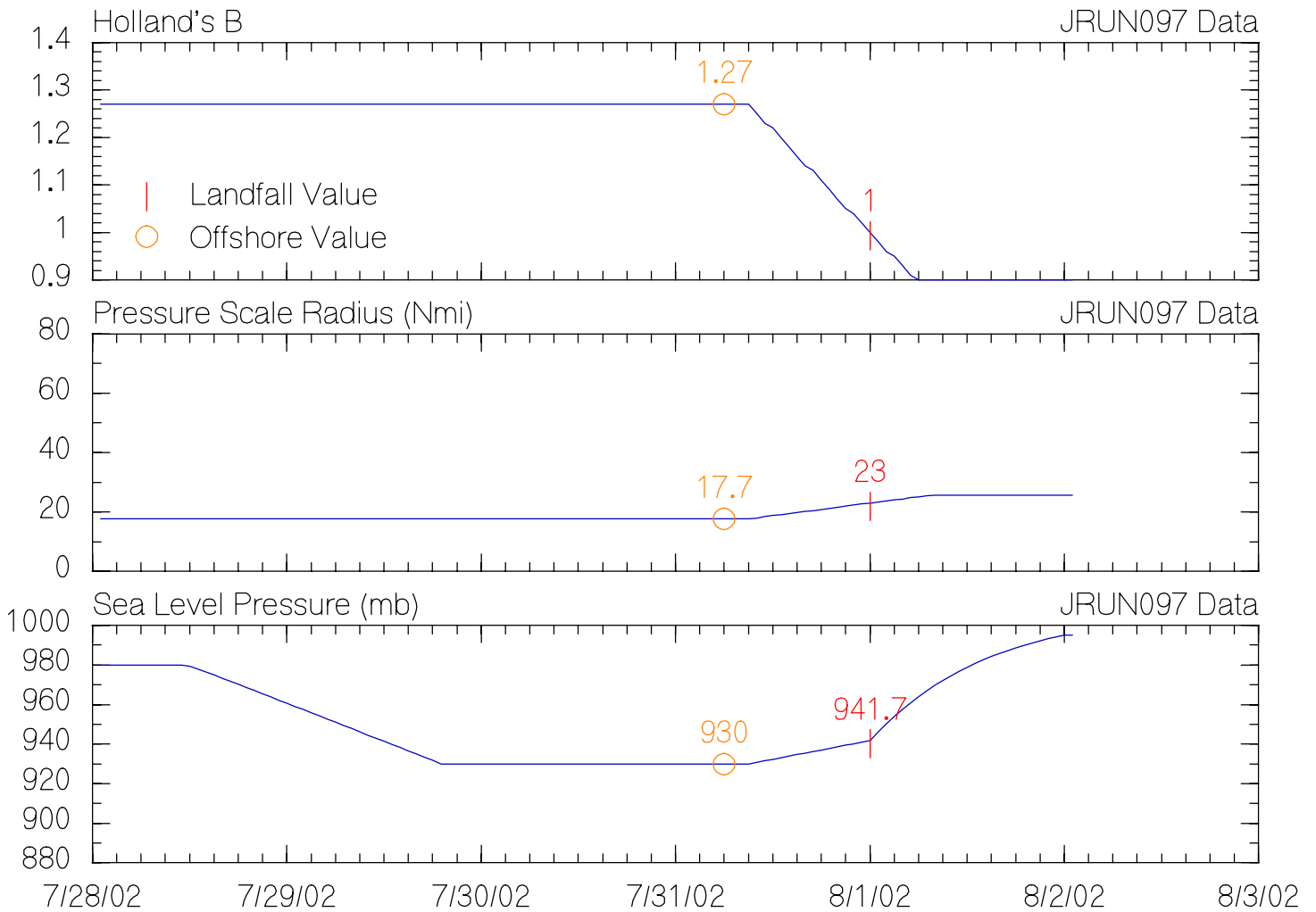
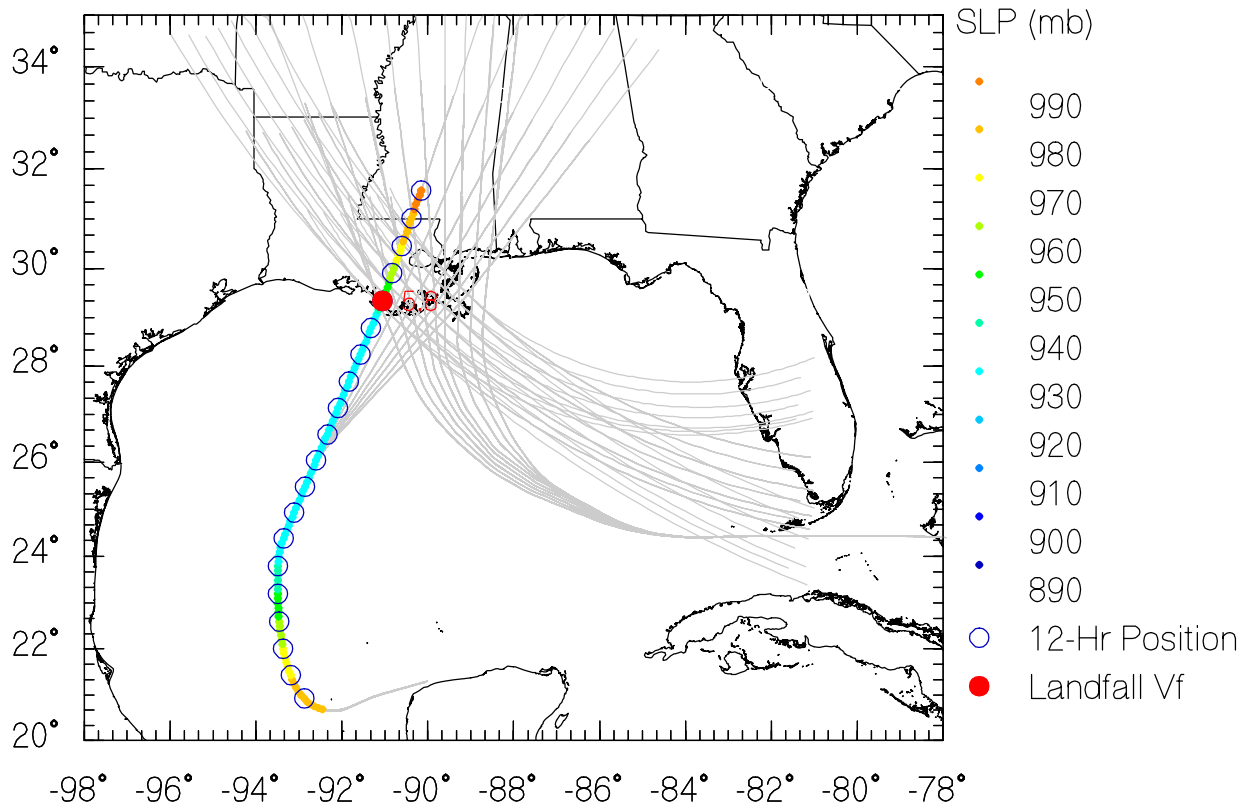

JRUN098 Data

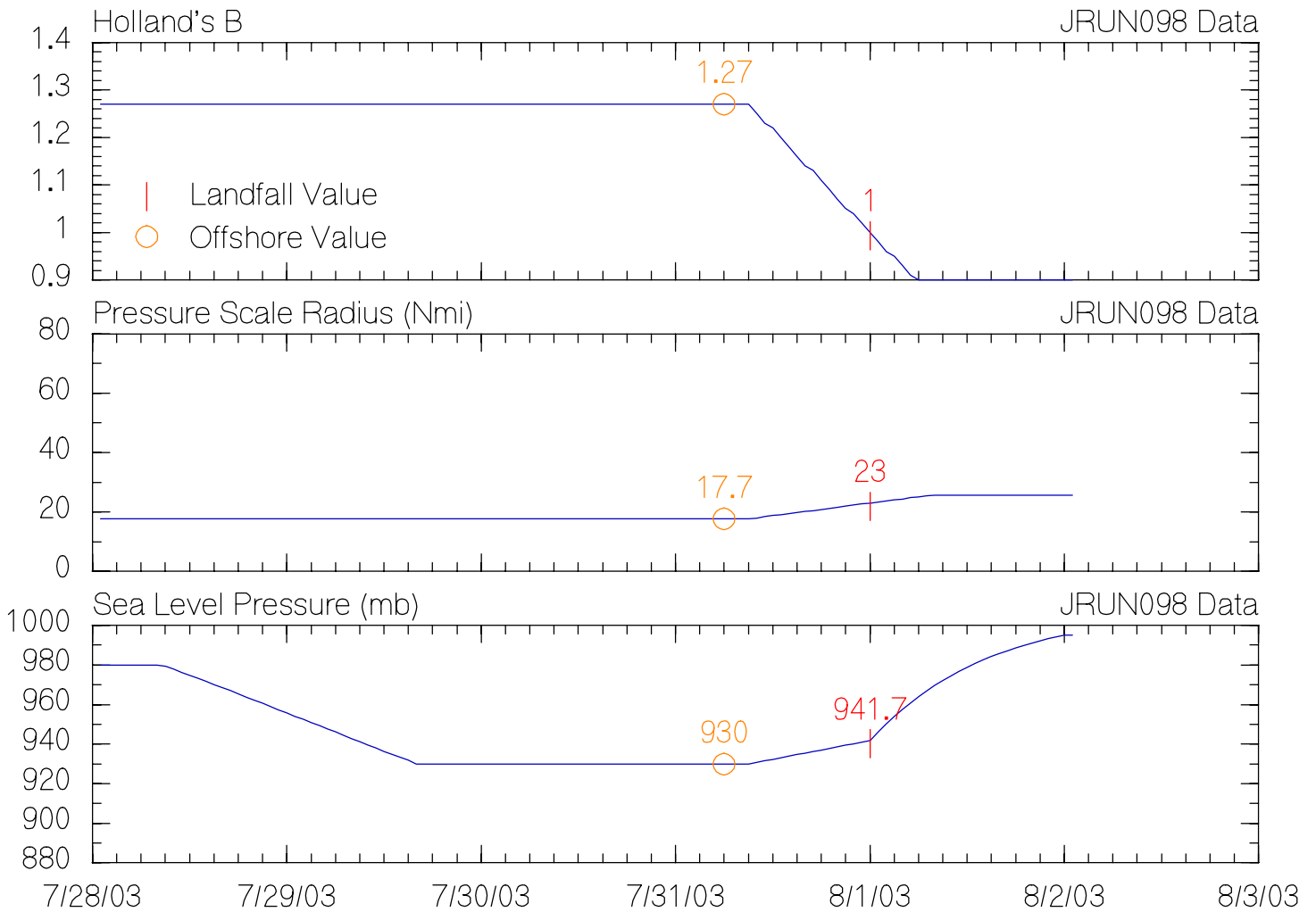
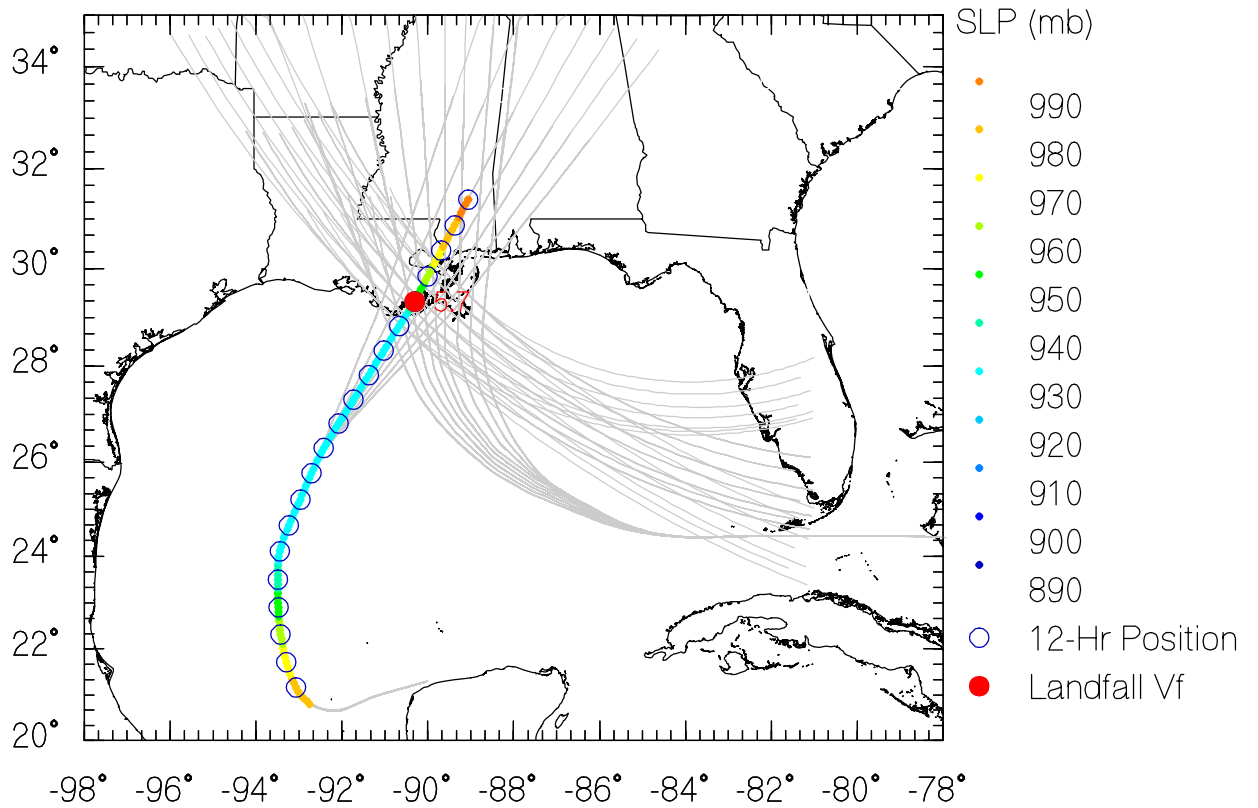

JRUN099 Data

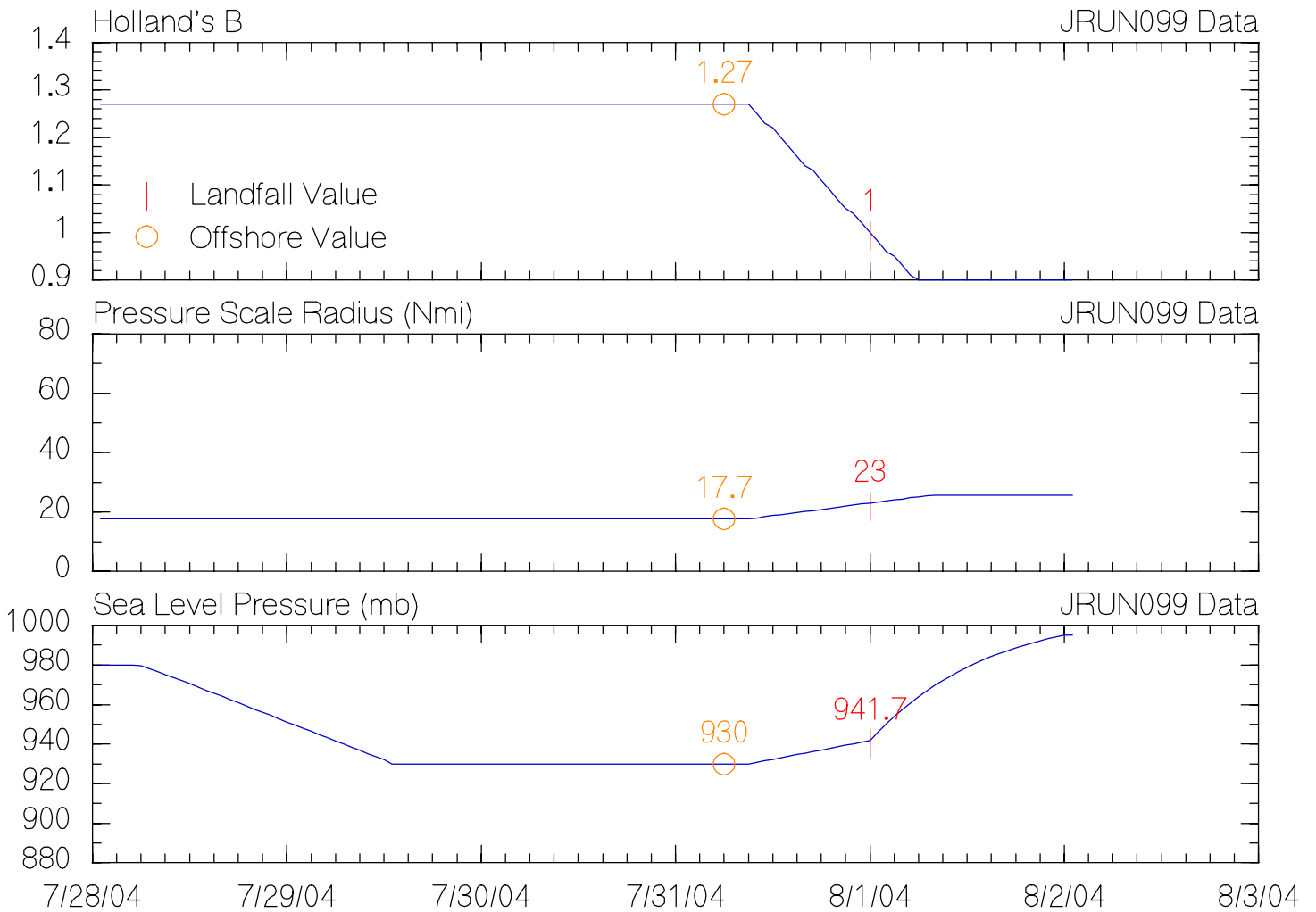
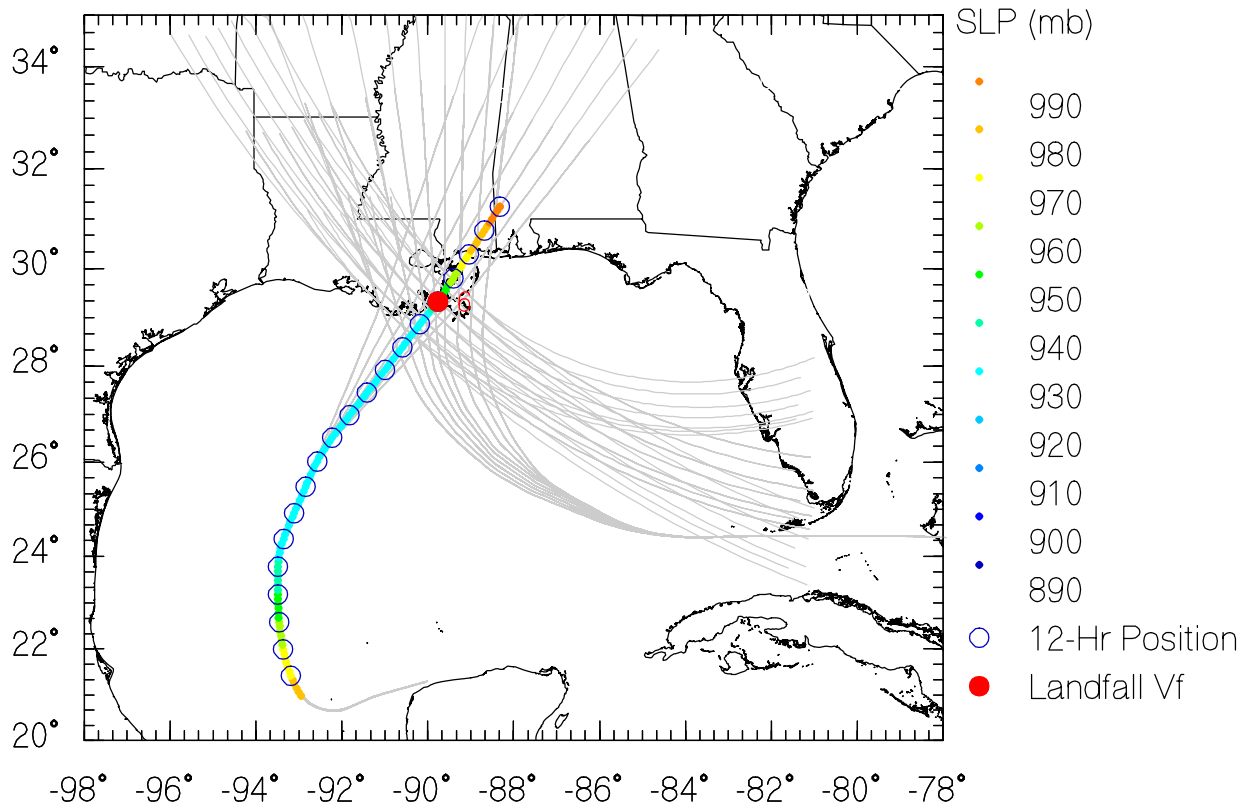

JRUN100 Data

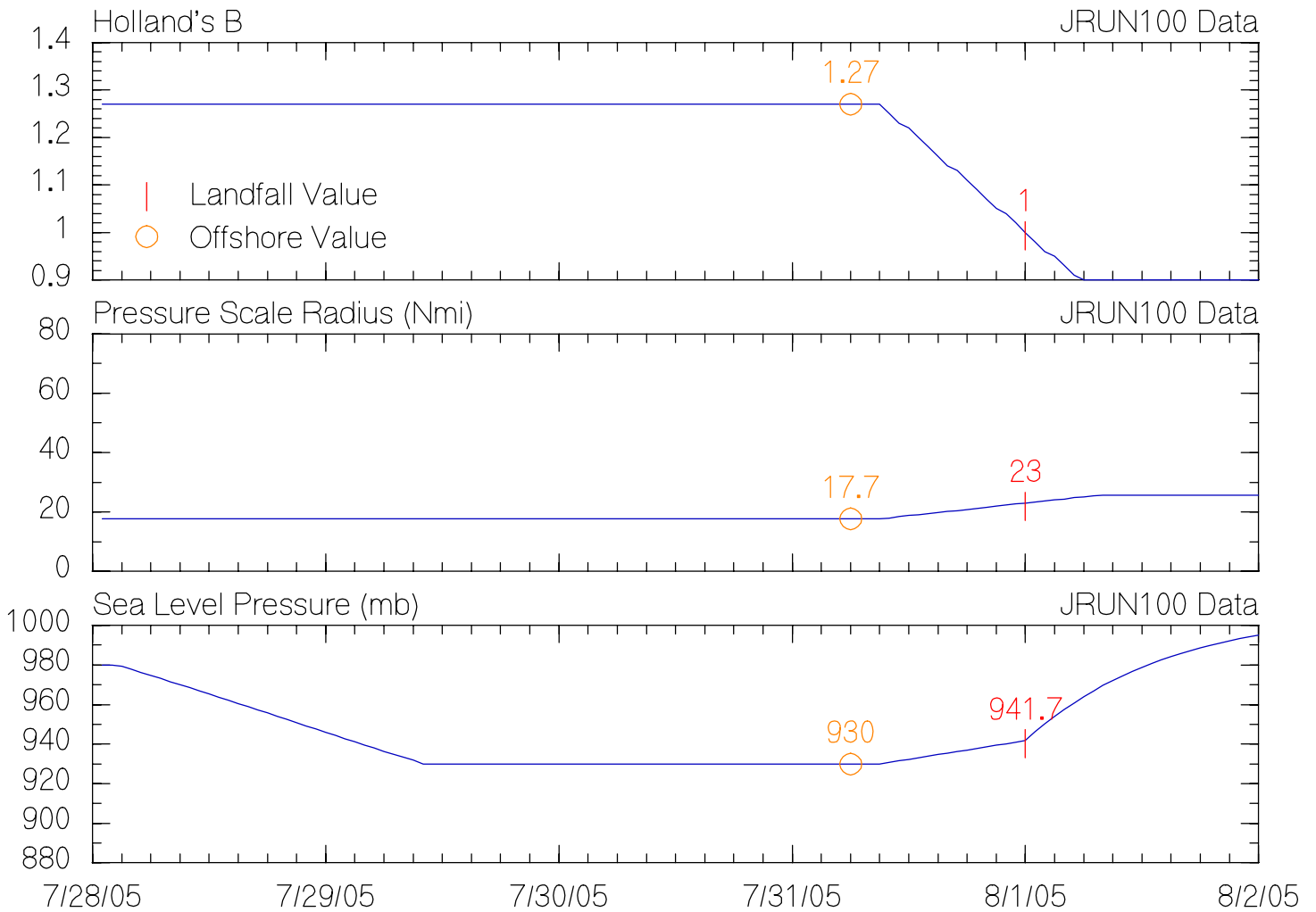
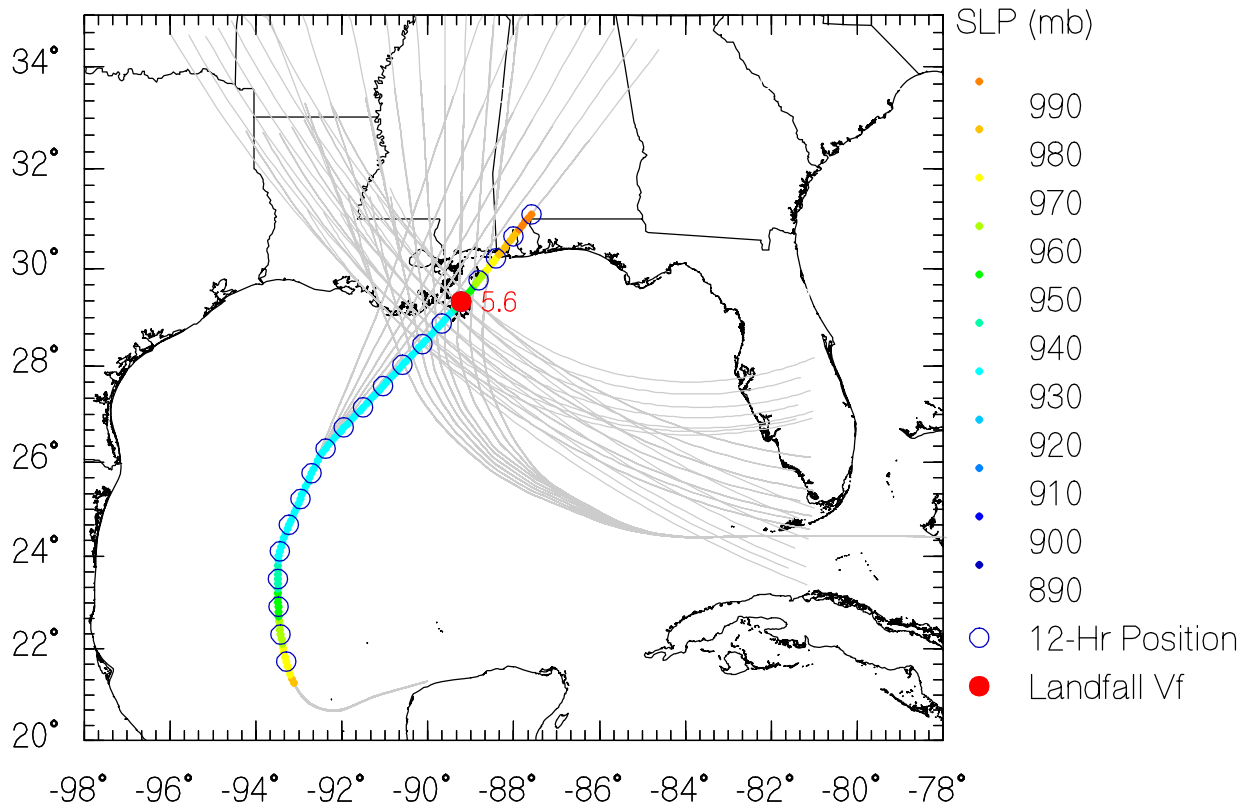

JRUN101 Data

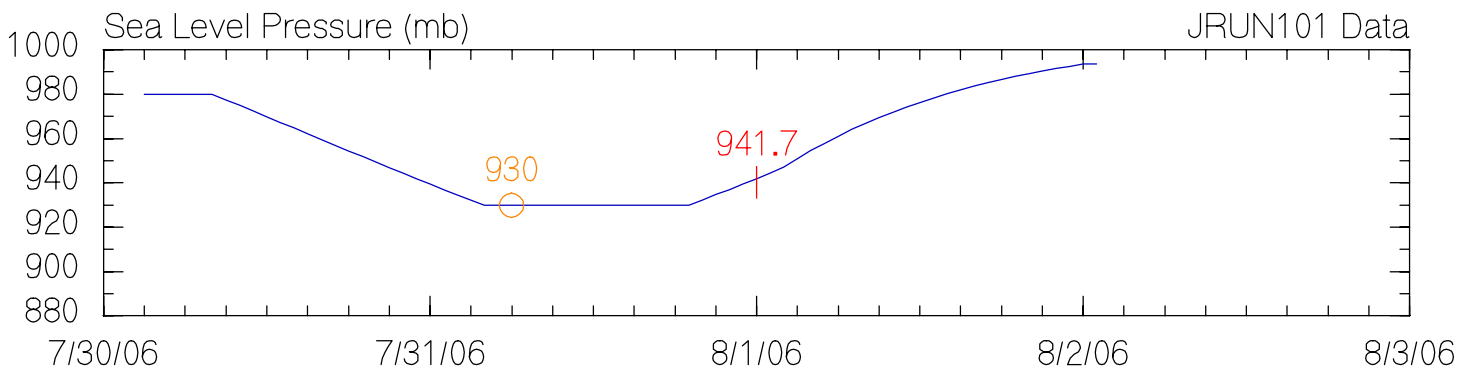
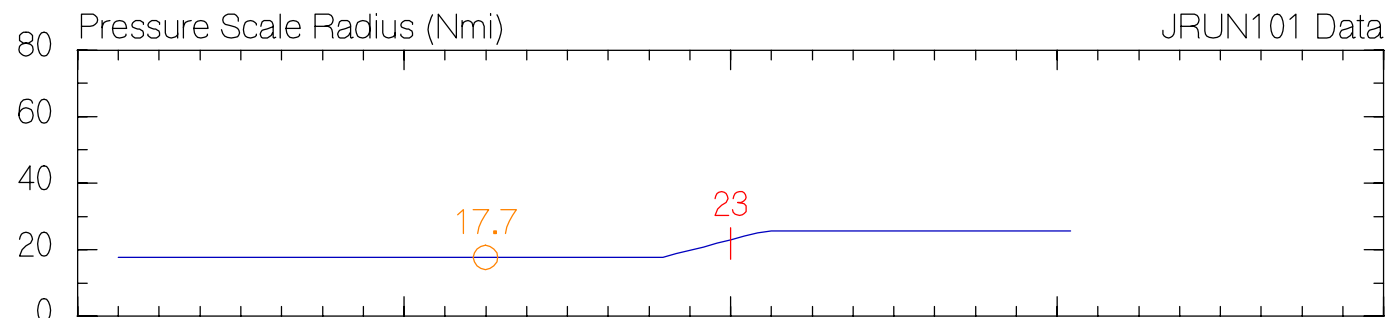
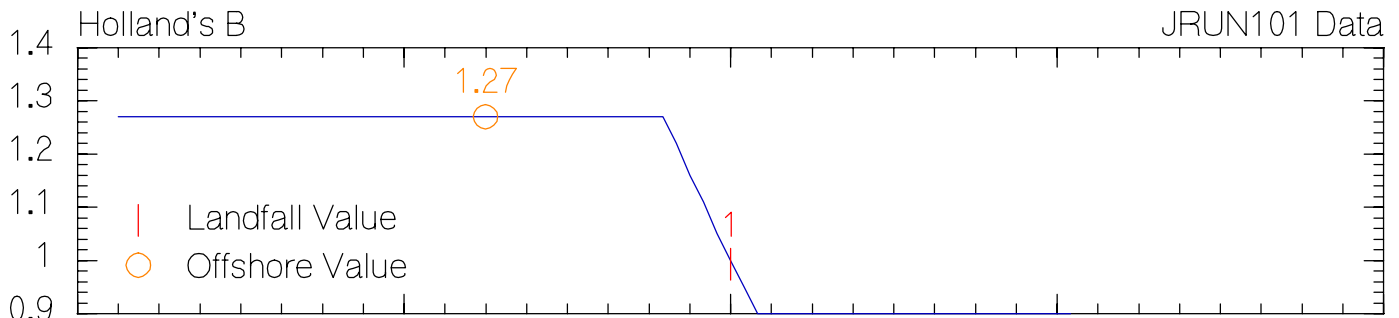
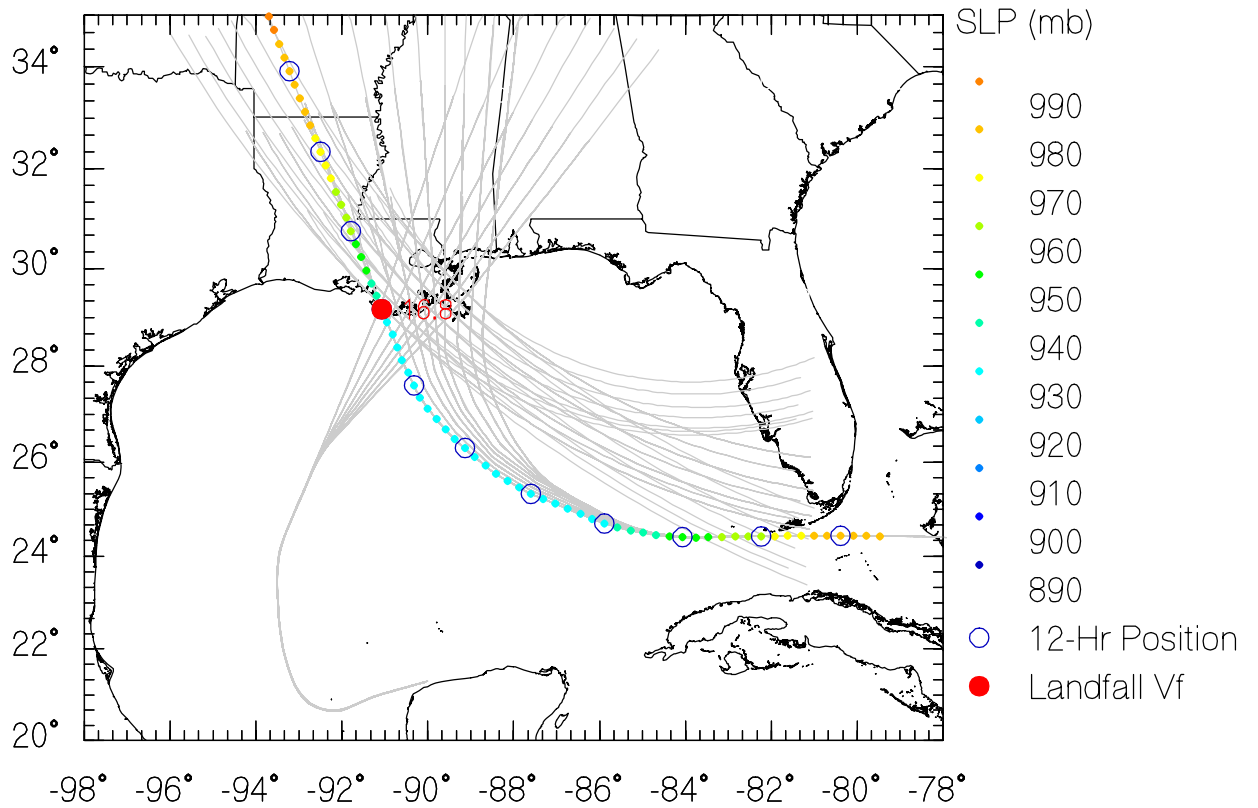

JRUN102 Data

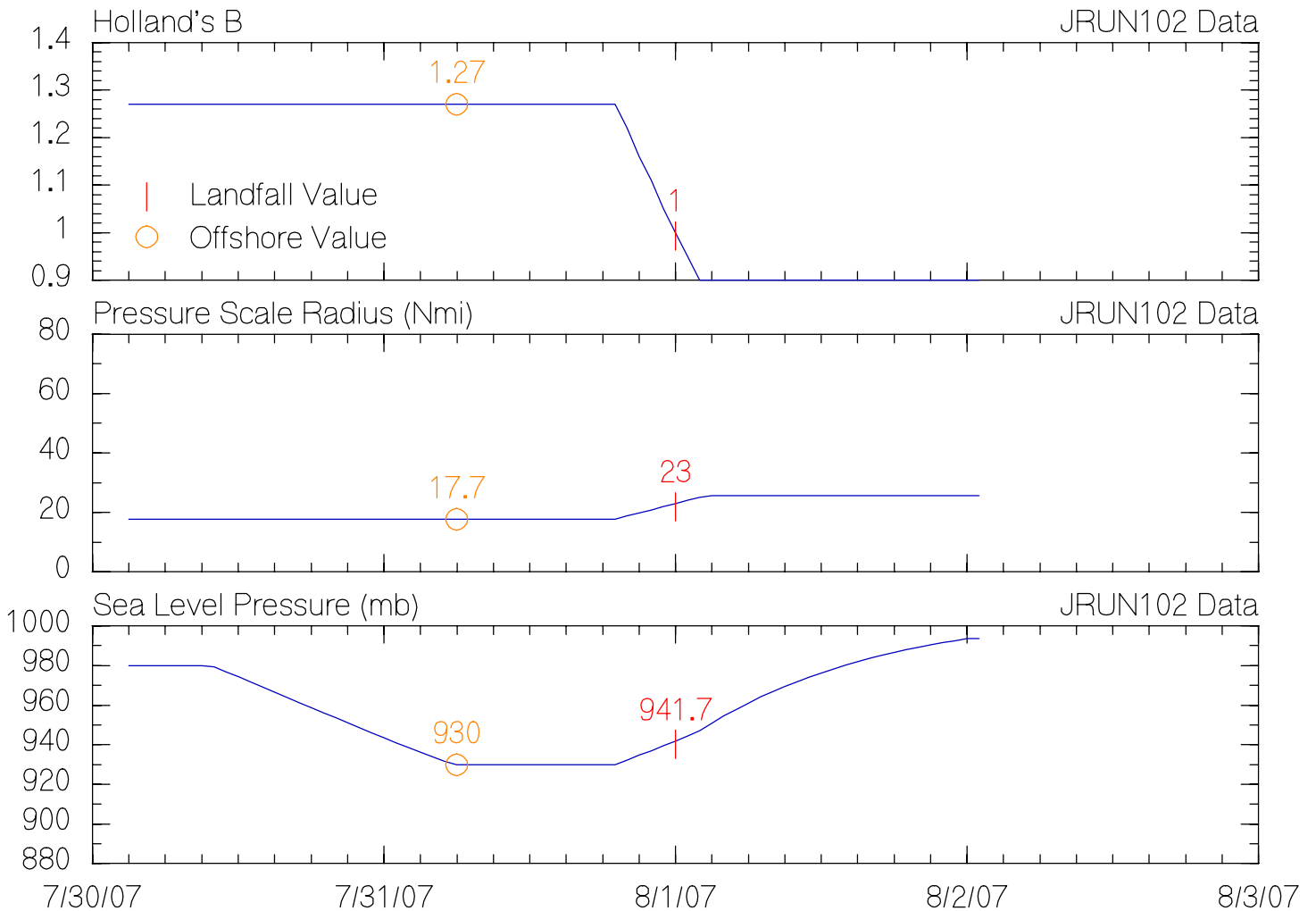
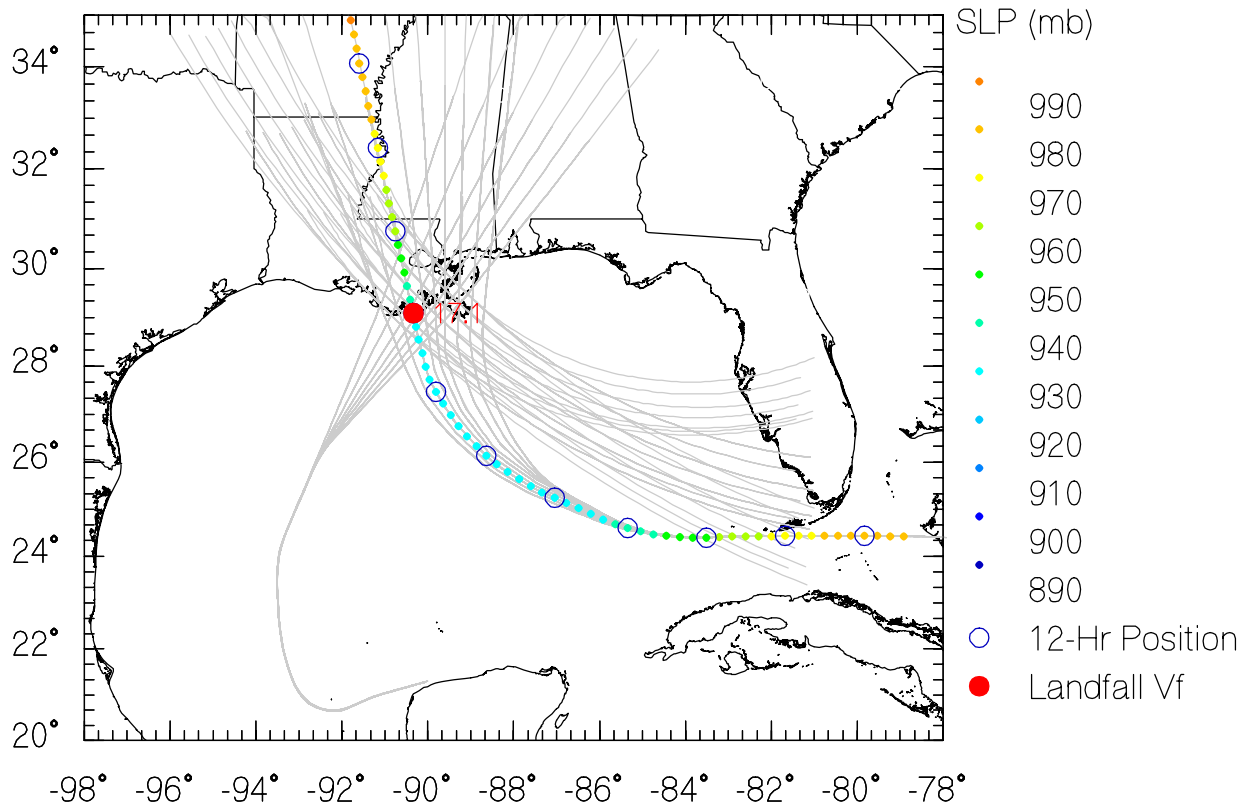

JRUN103 Data

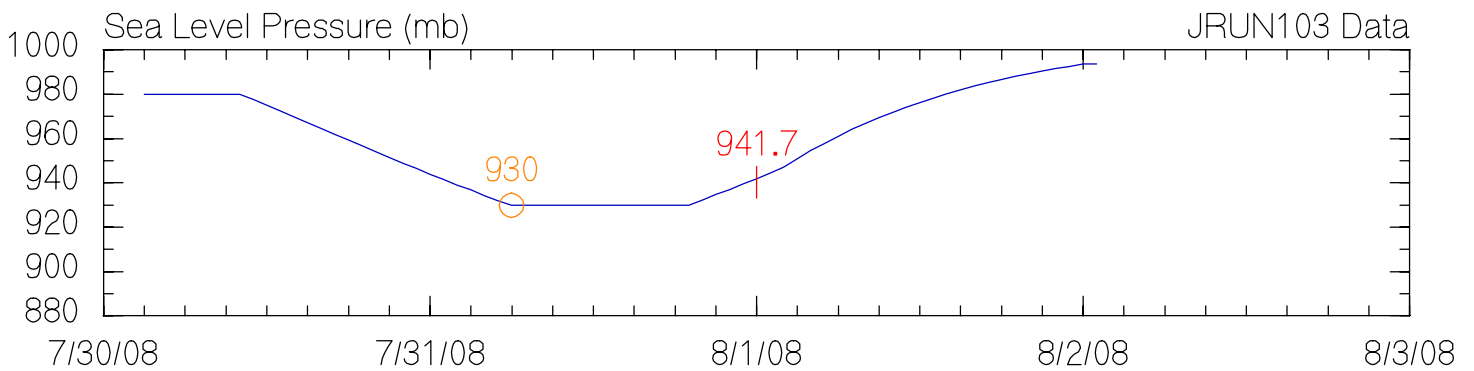
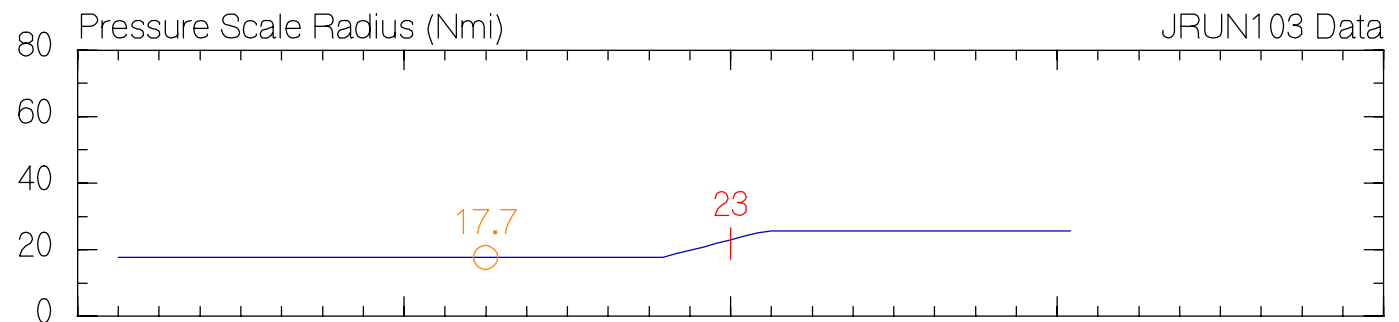
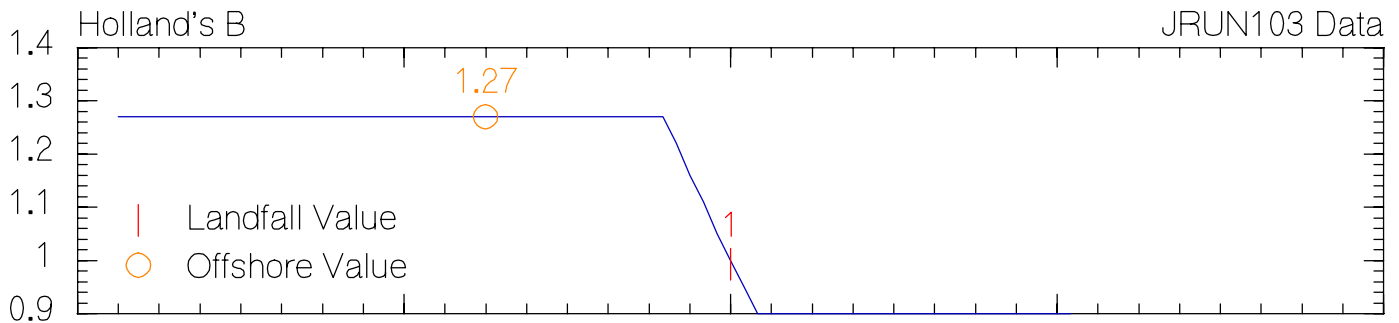
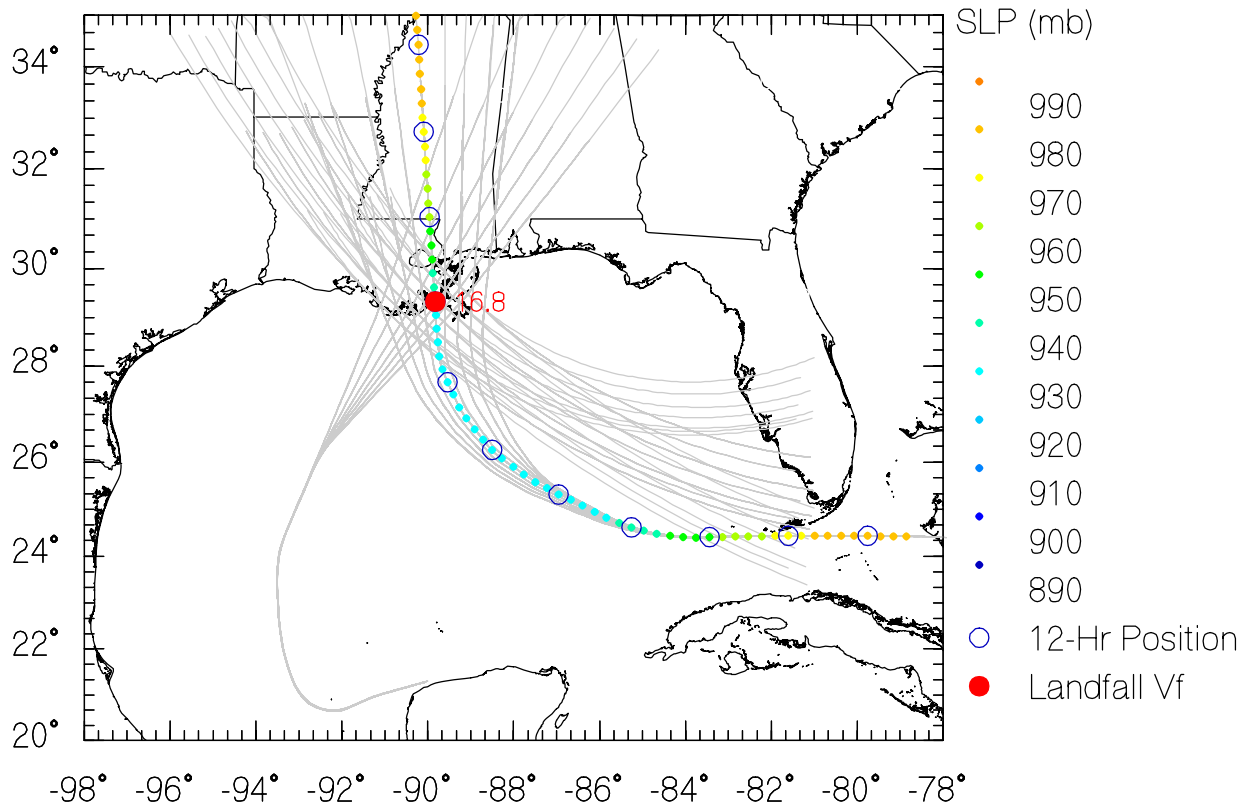

JRUN104 Data

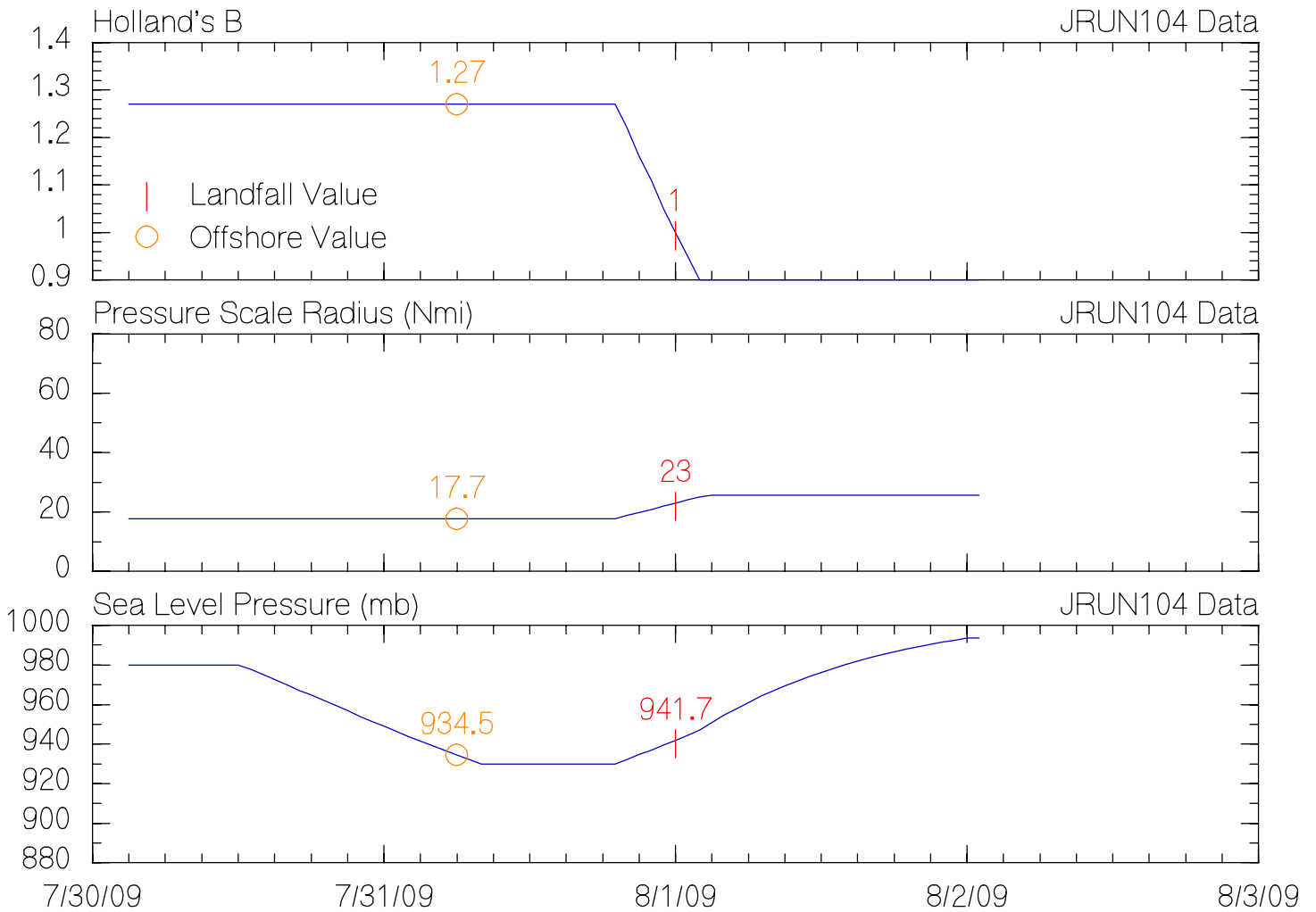
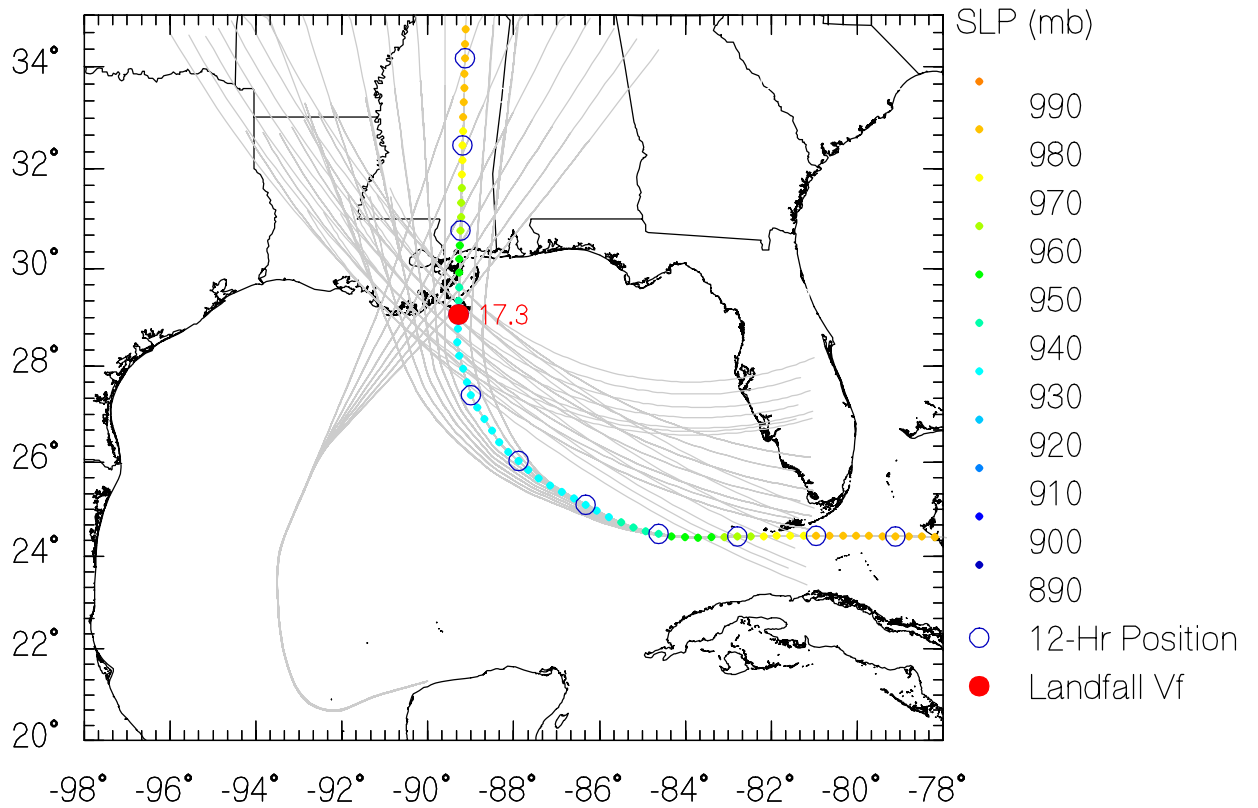

JRUN105 Data

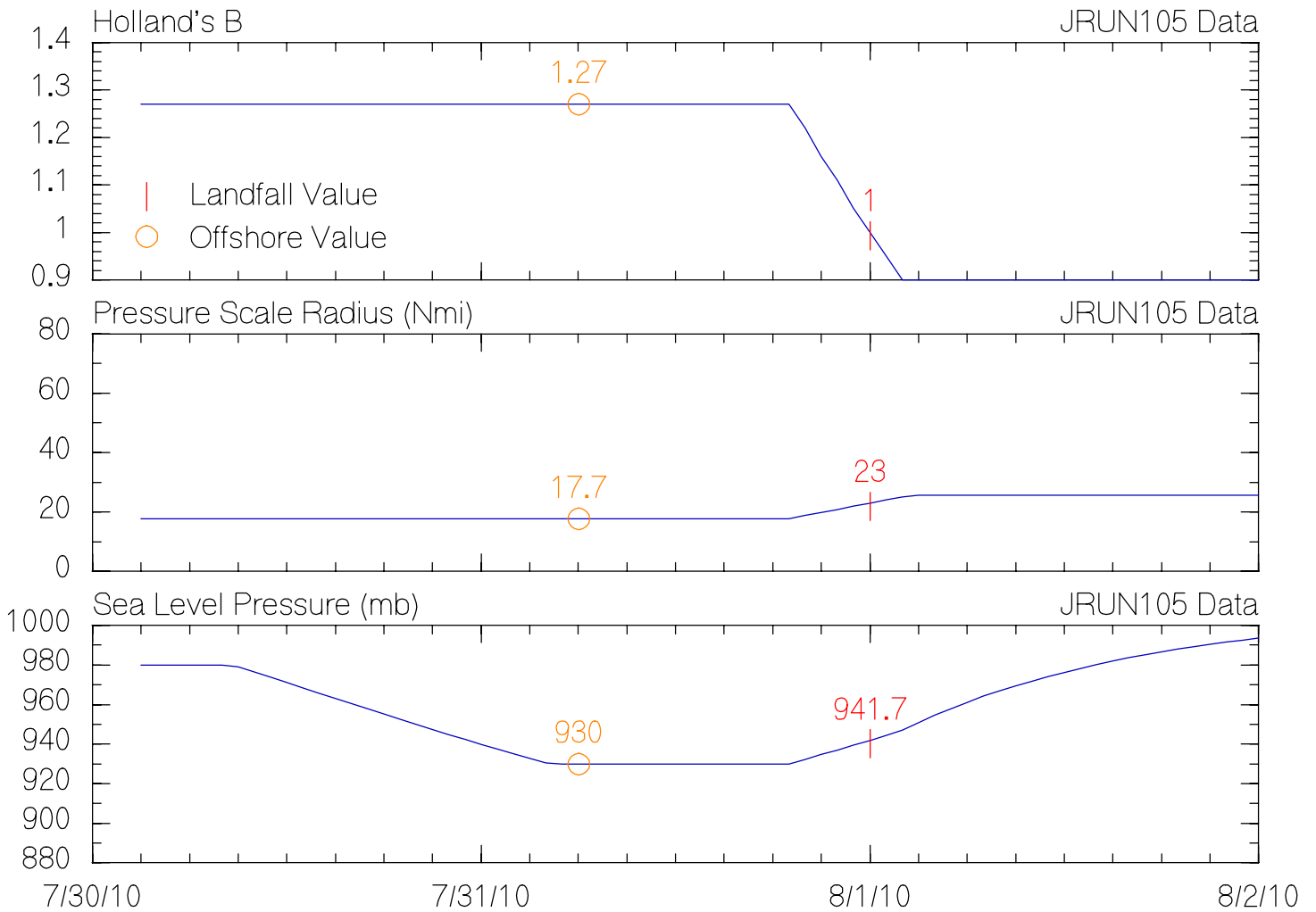
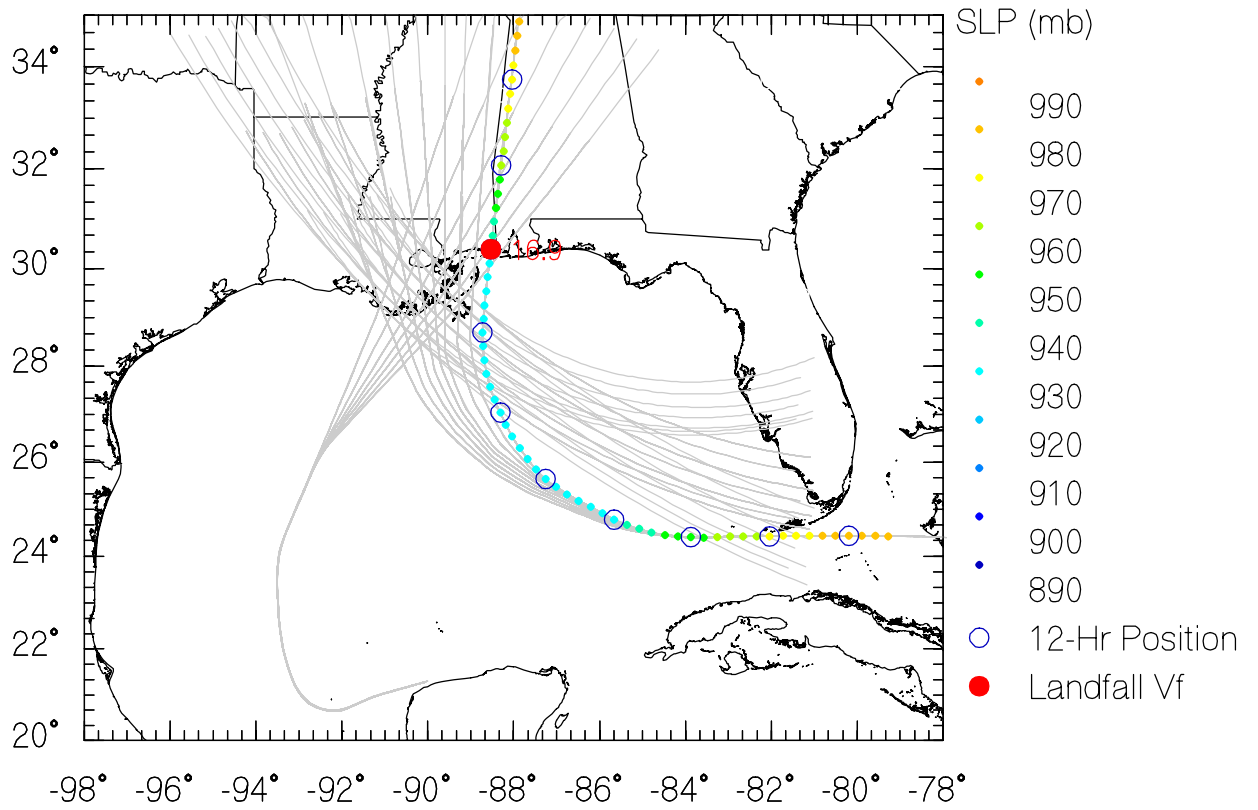

JRUN106 Data

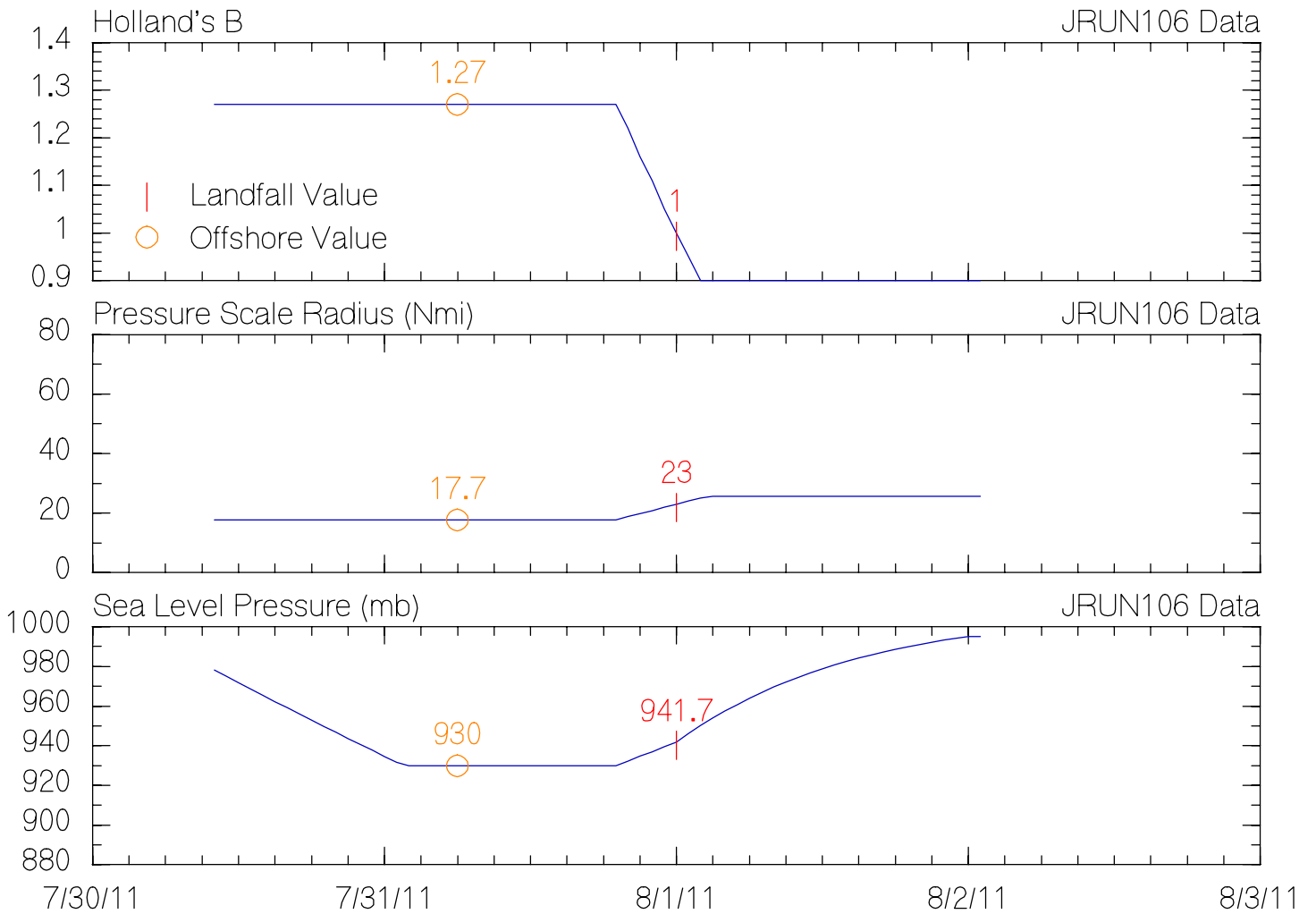
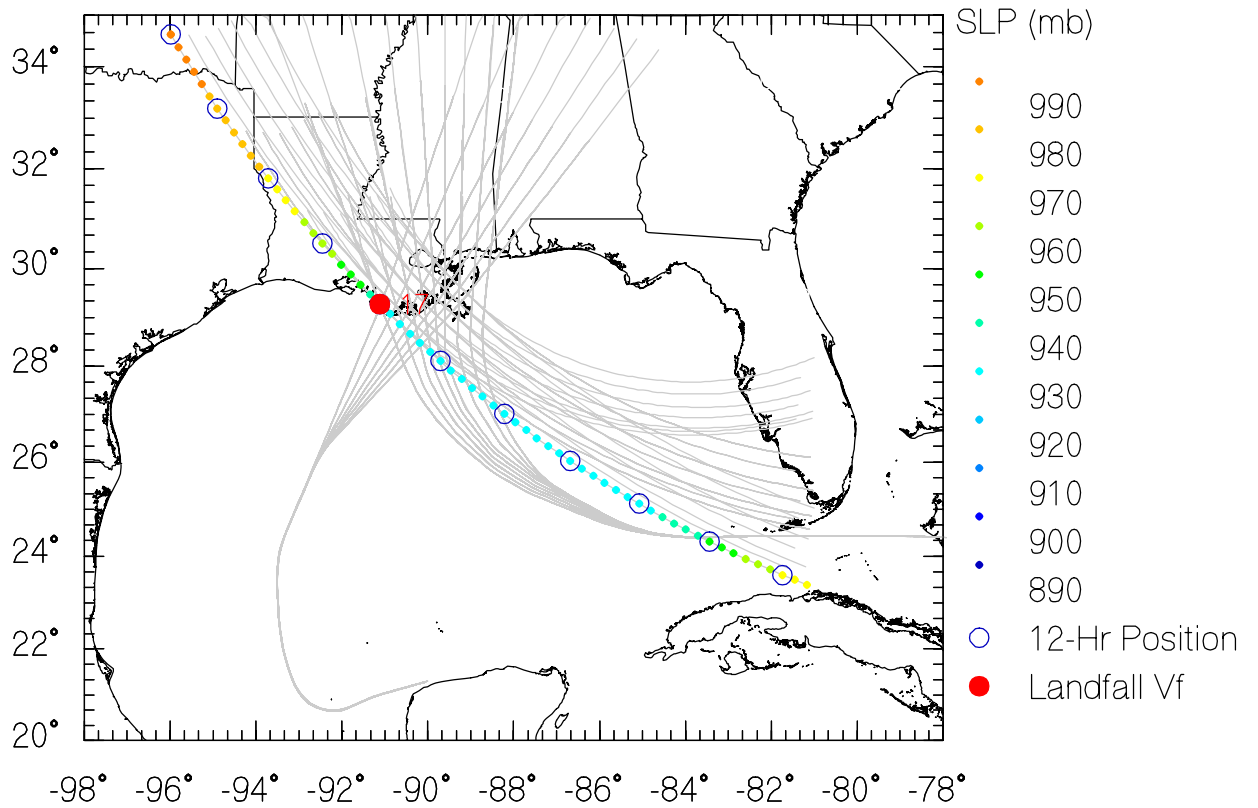

JRUN107 Data

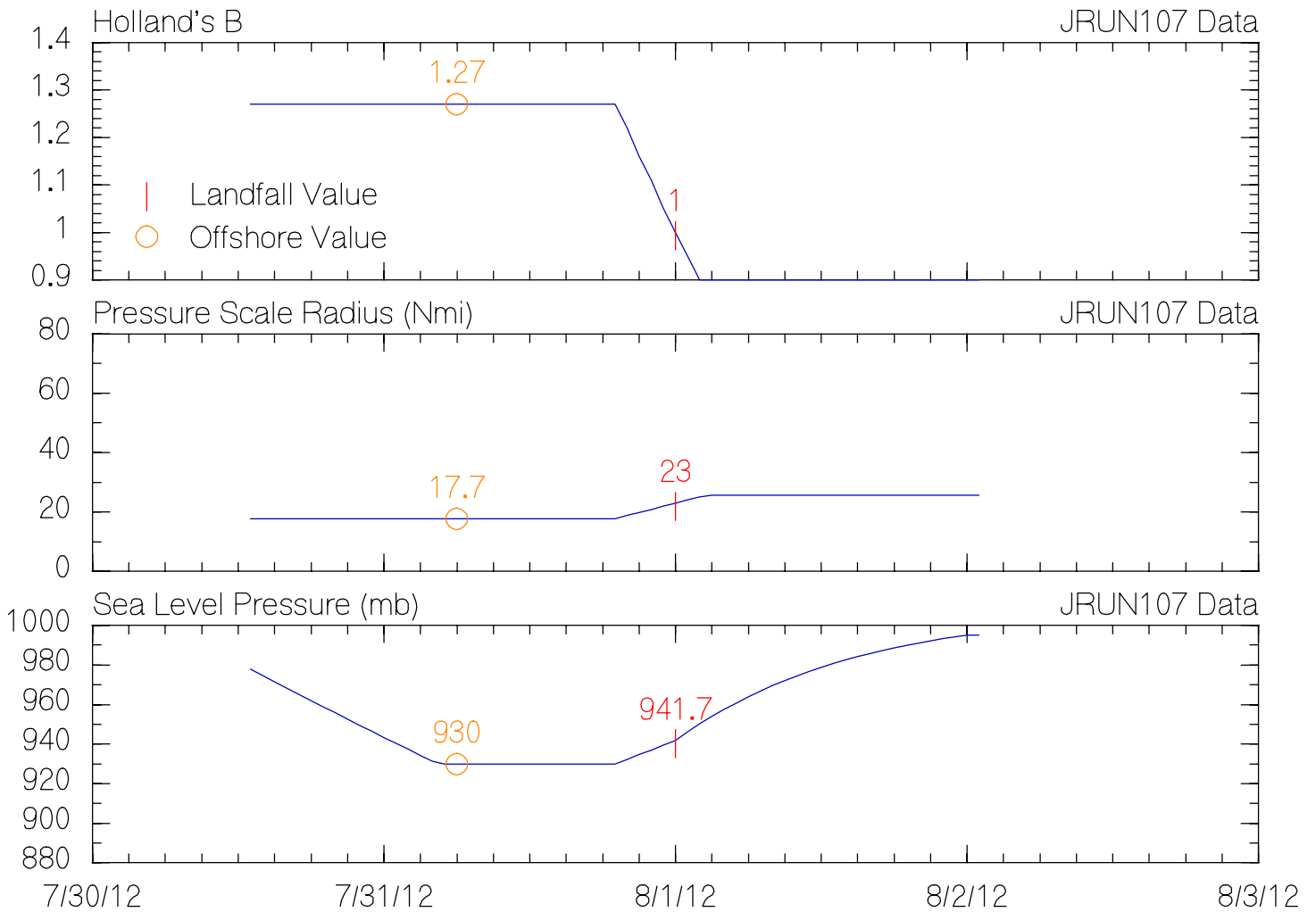
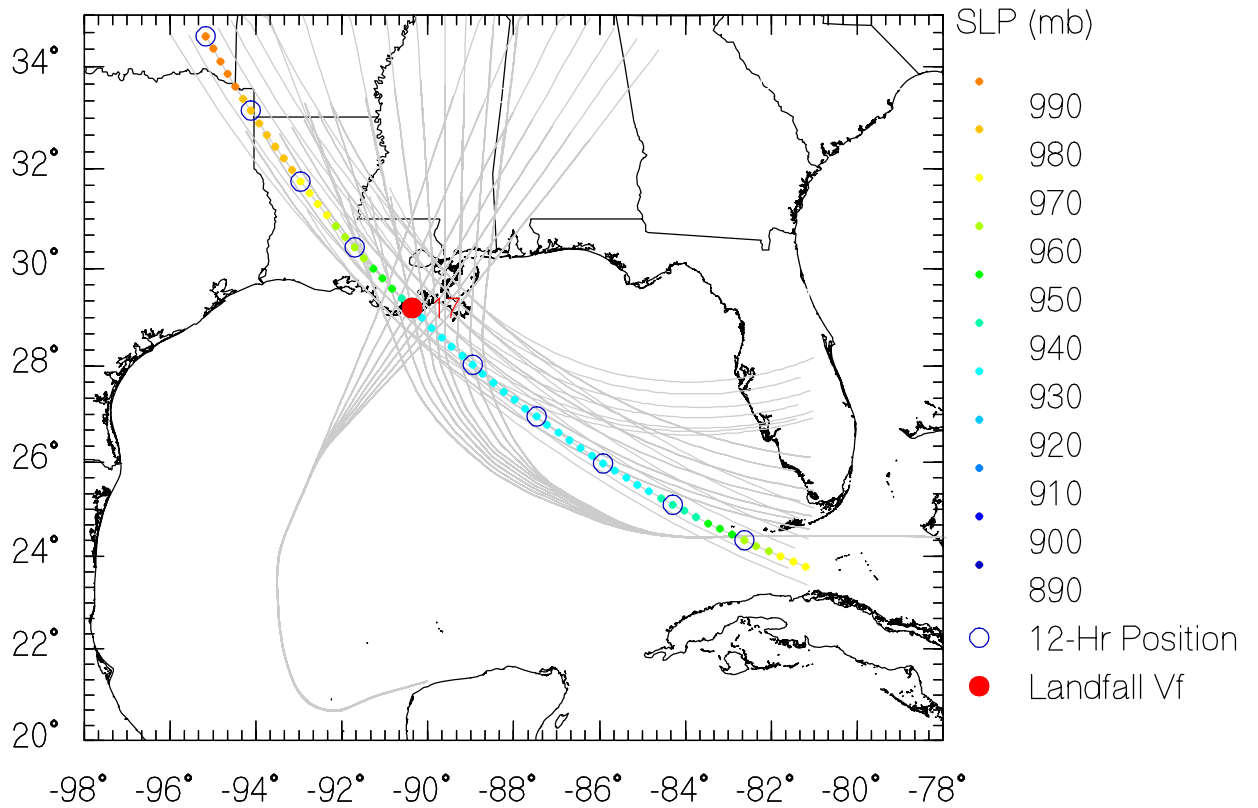

JRUN108 Data

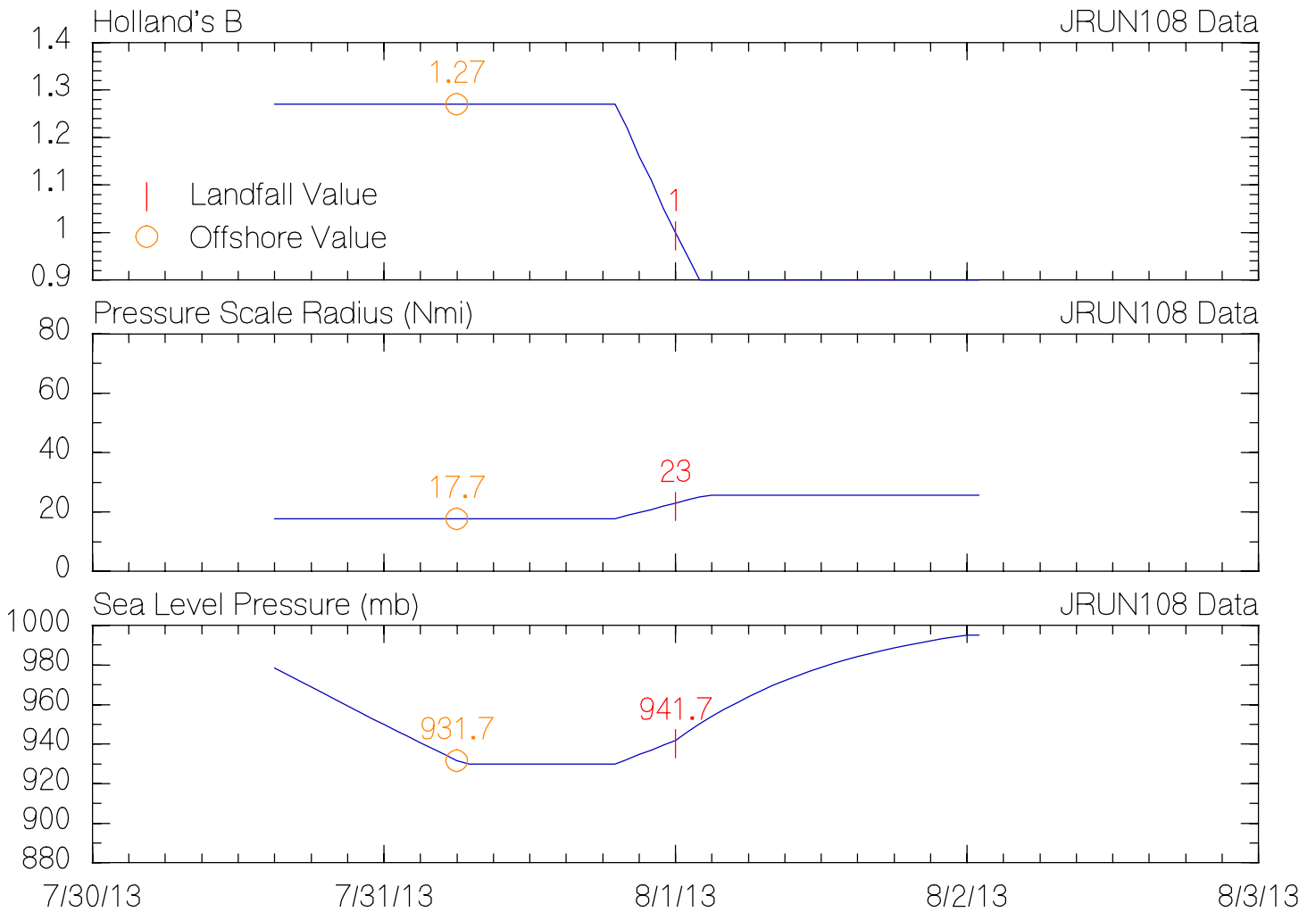
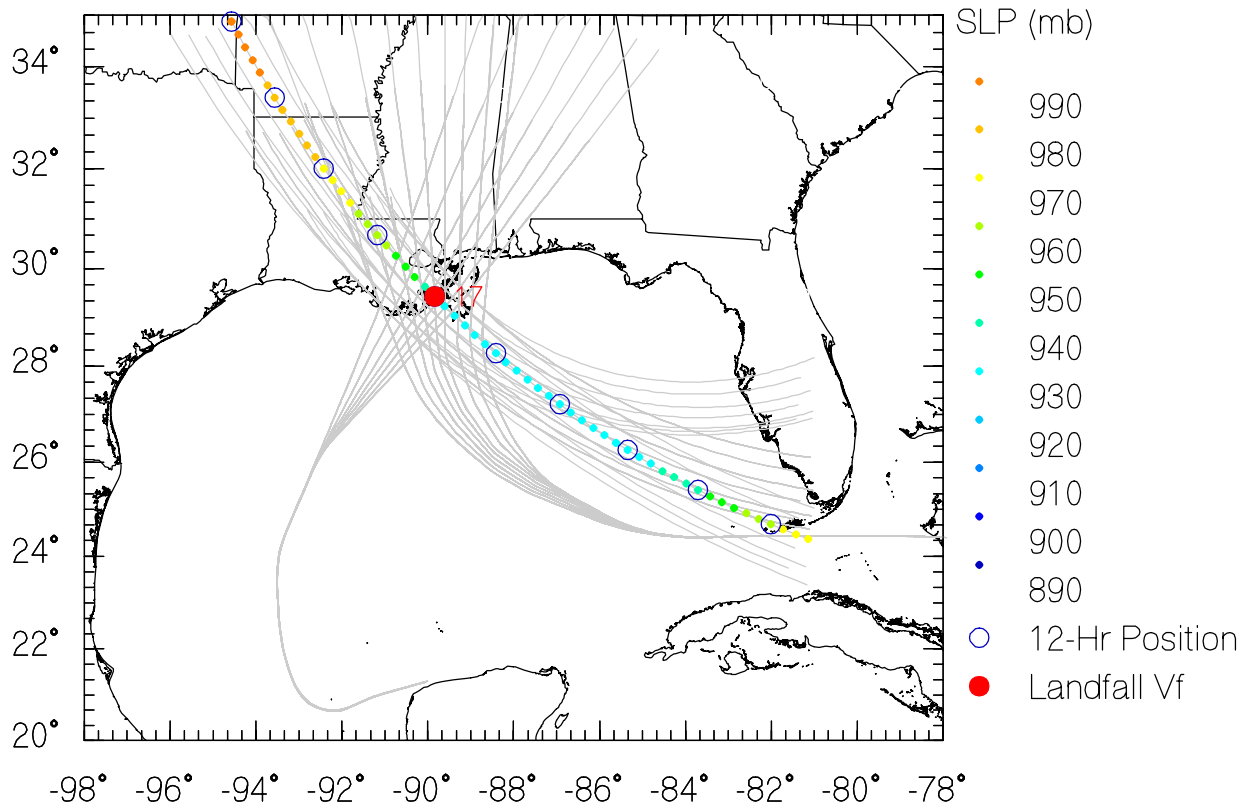

JRUN109 Data

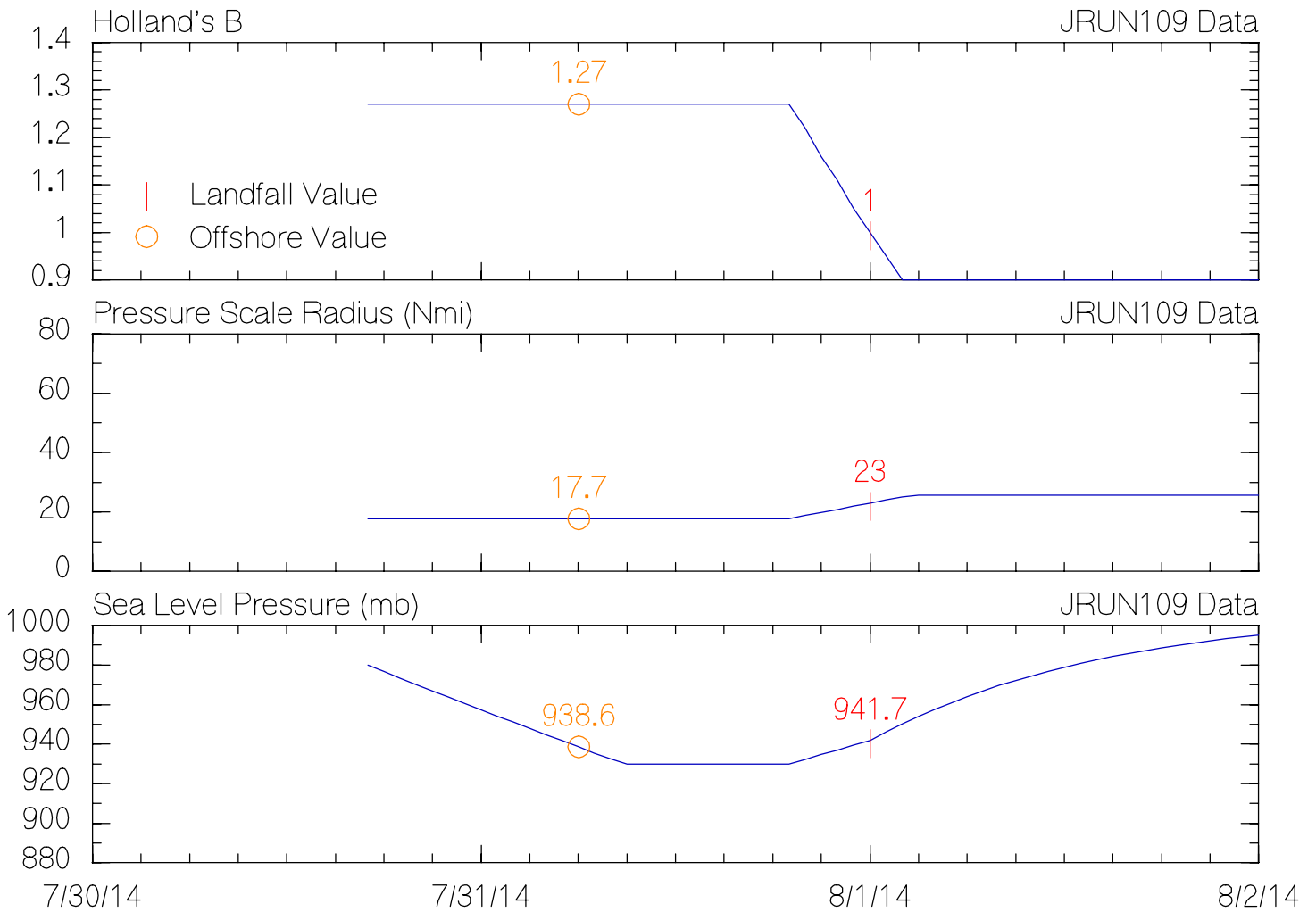
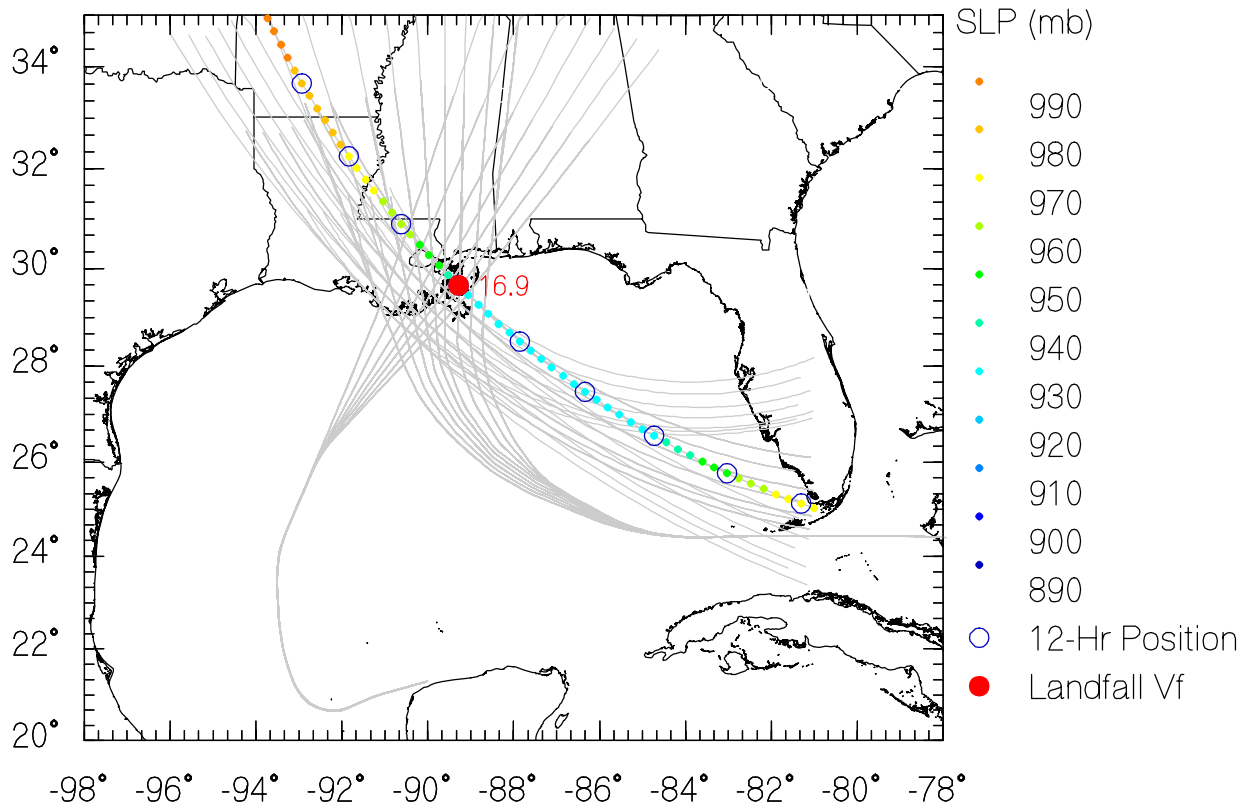

JRUN111 Data

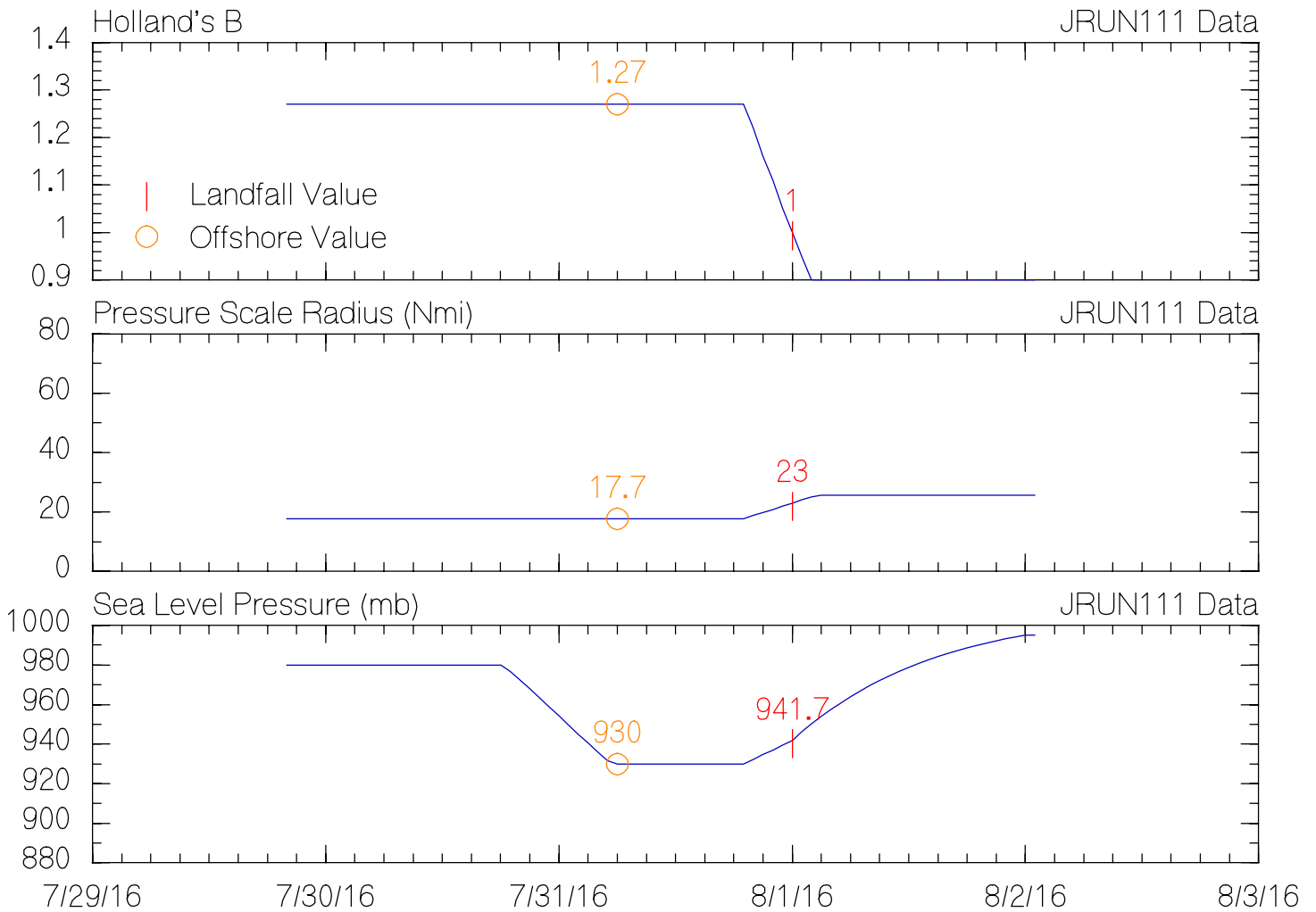
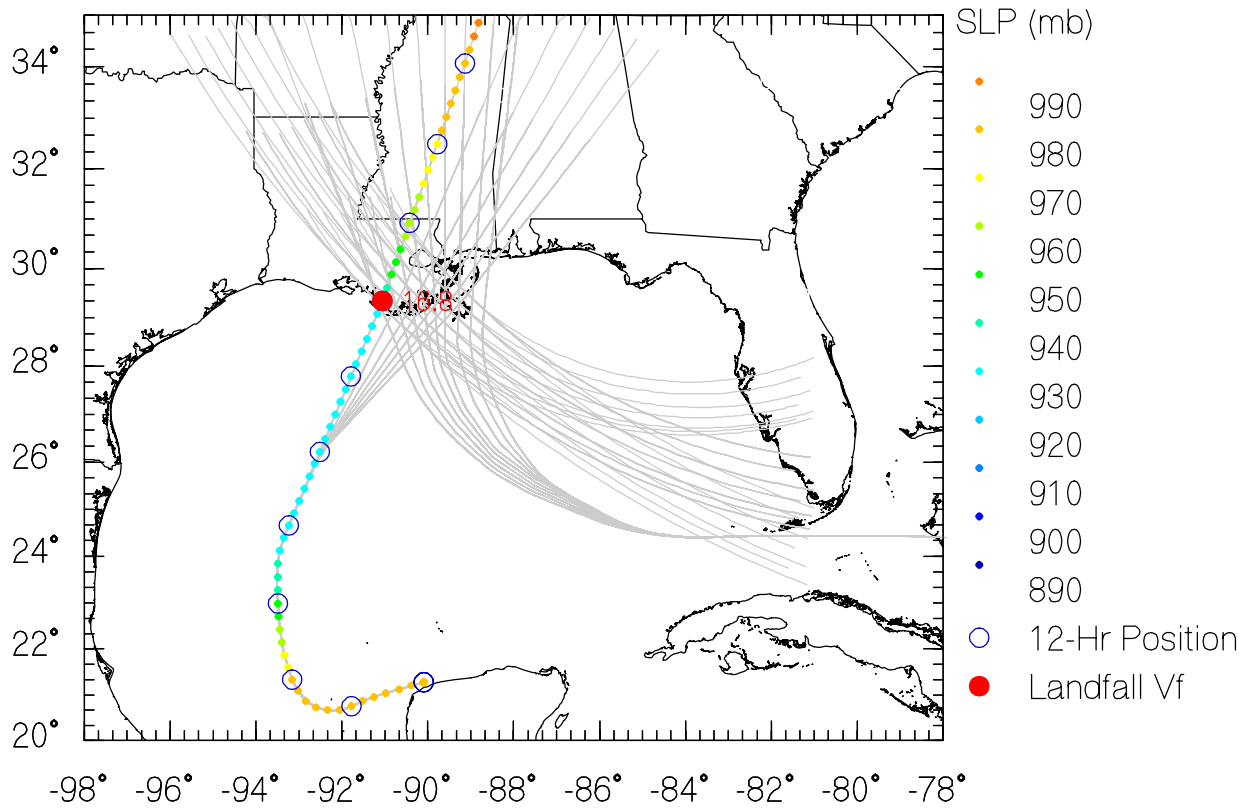

JRUN112 Data

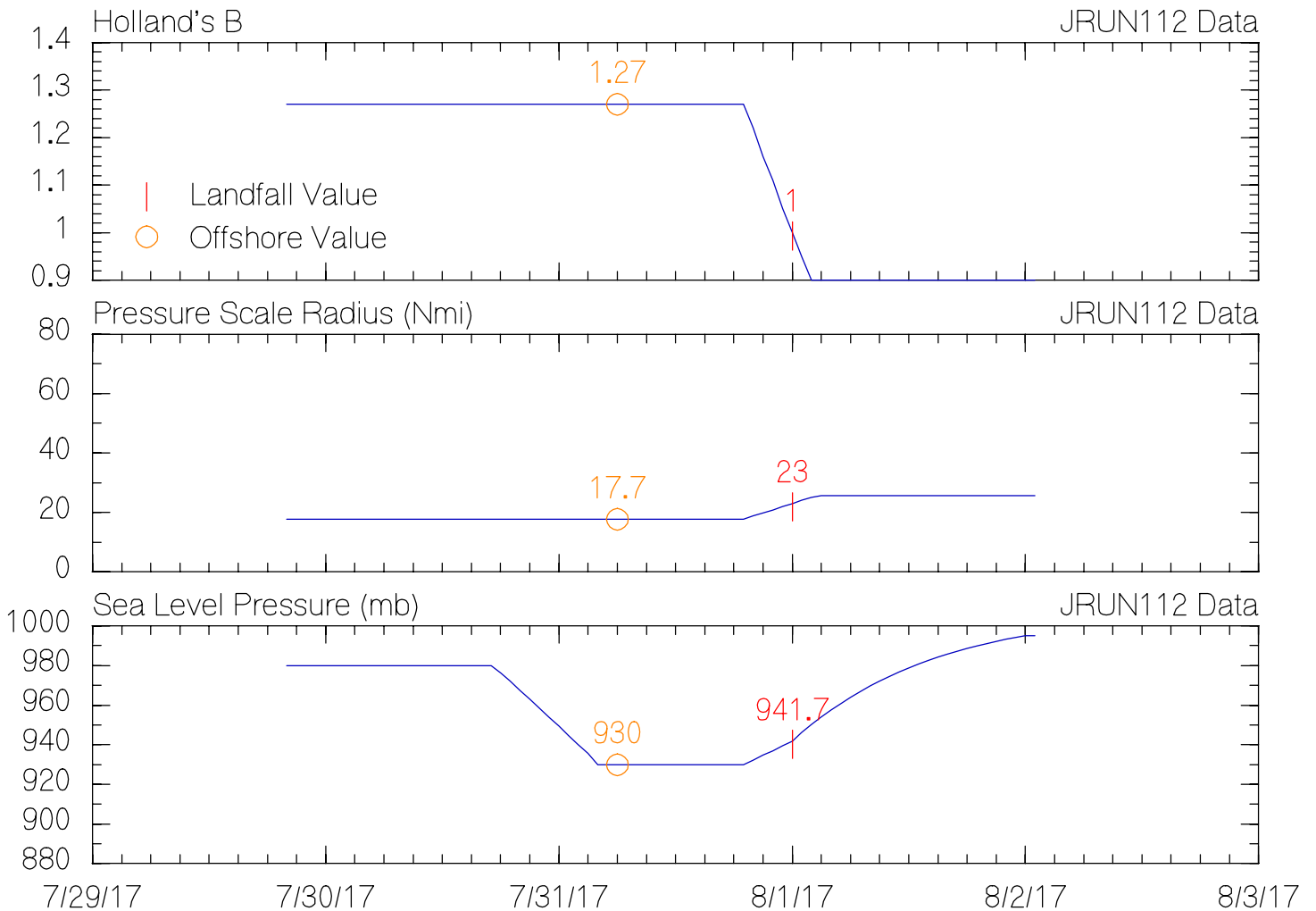
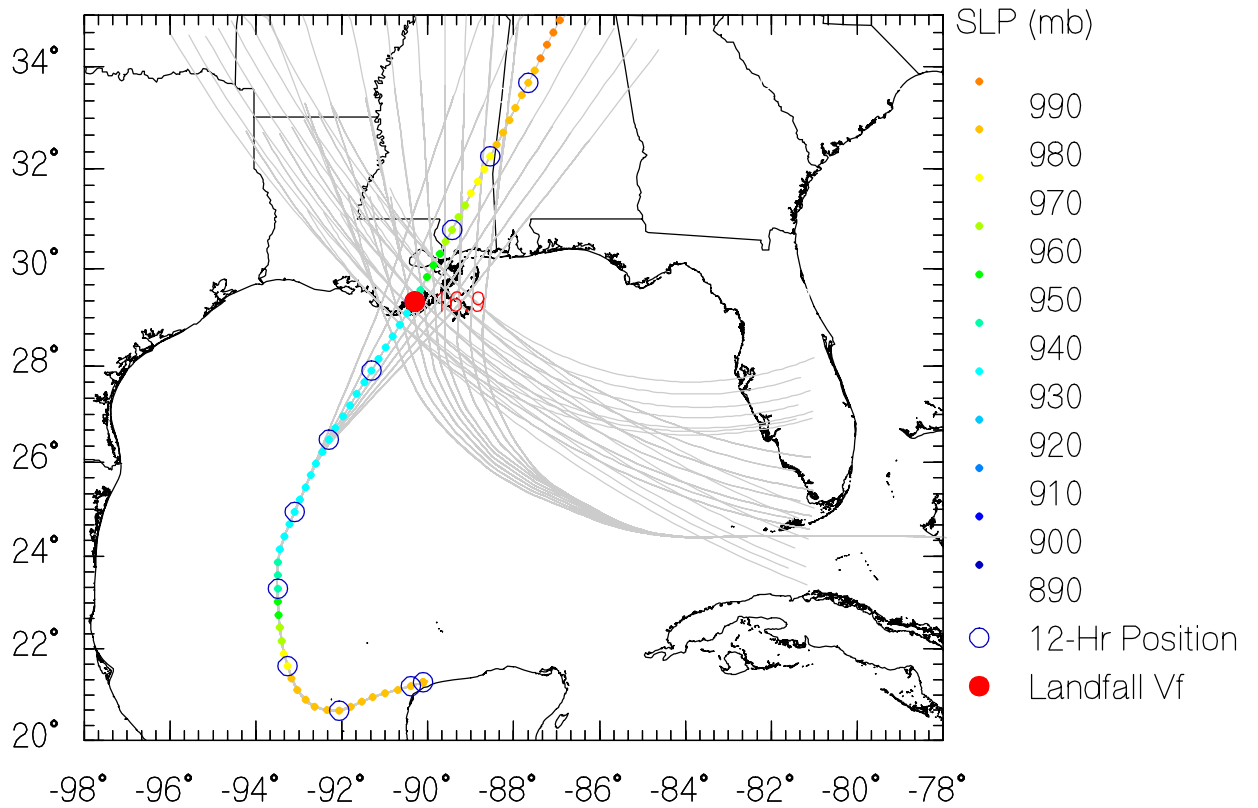

JRUN113 Data

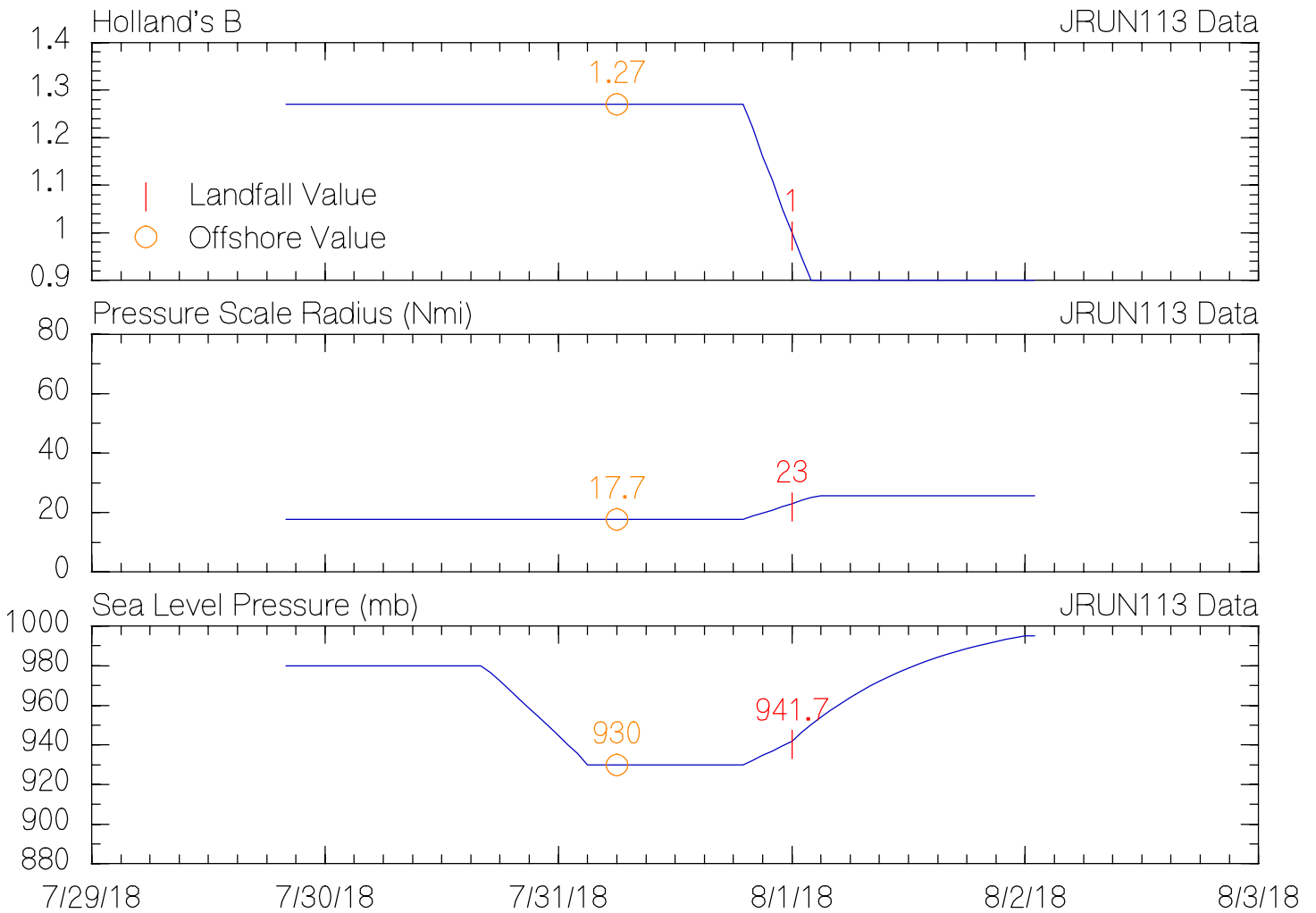
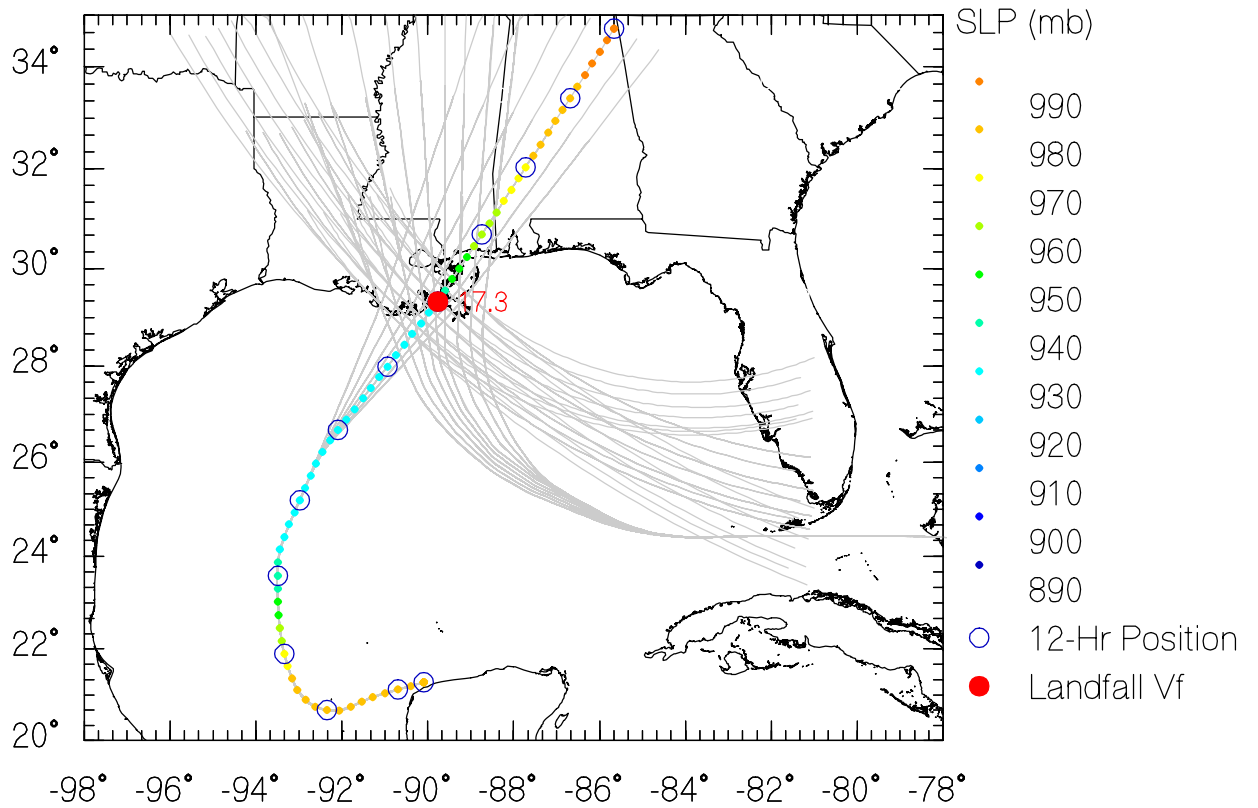

JRUN114 Data

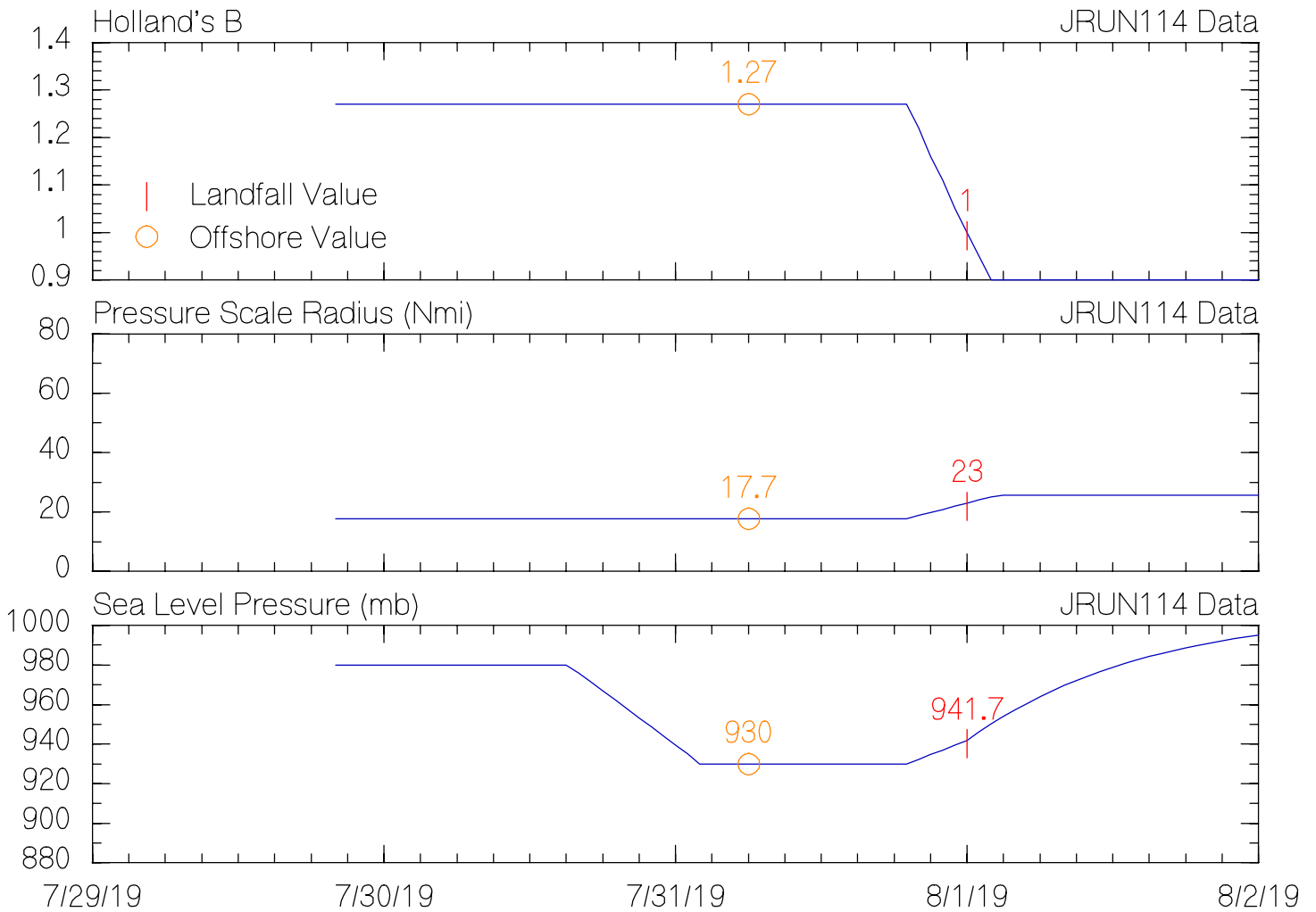
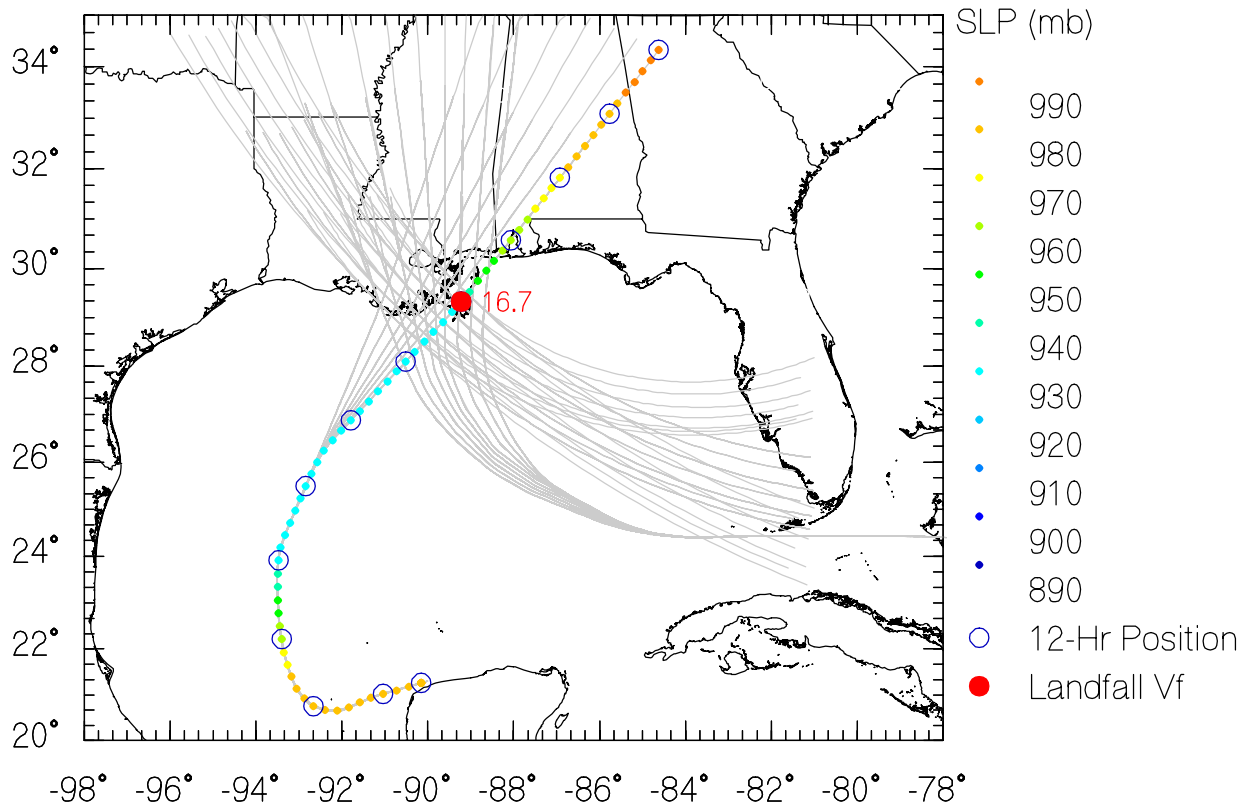

JRUN115 Data

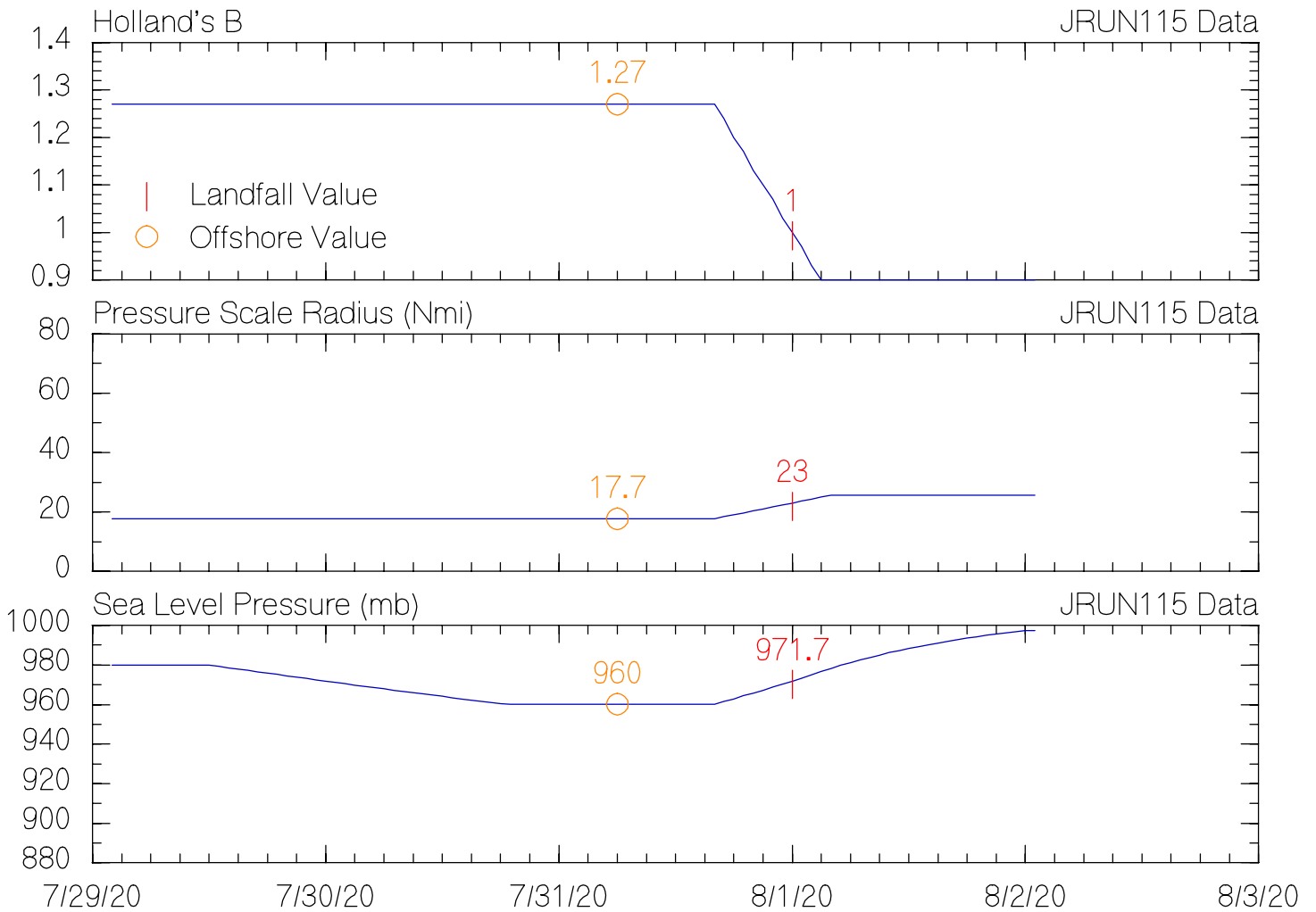
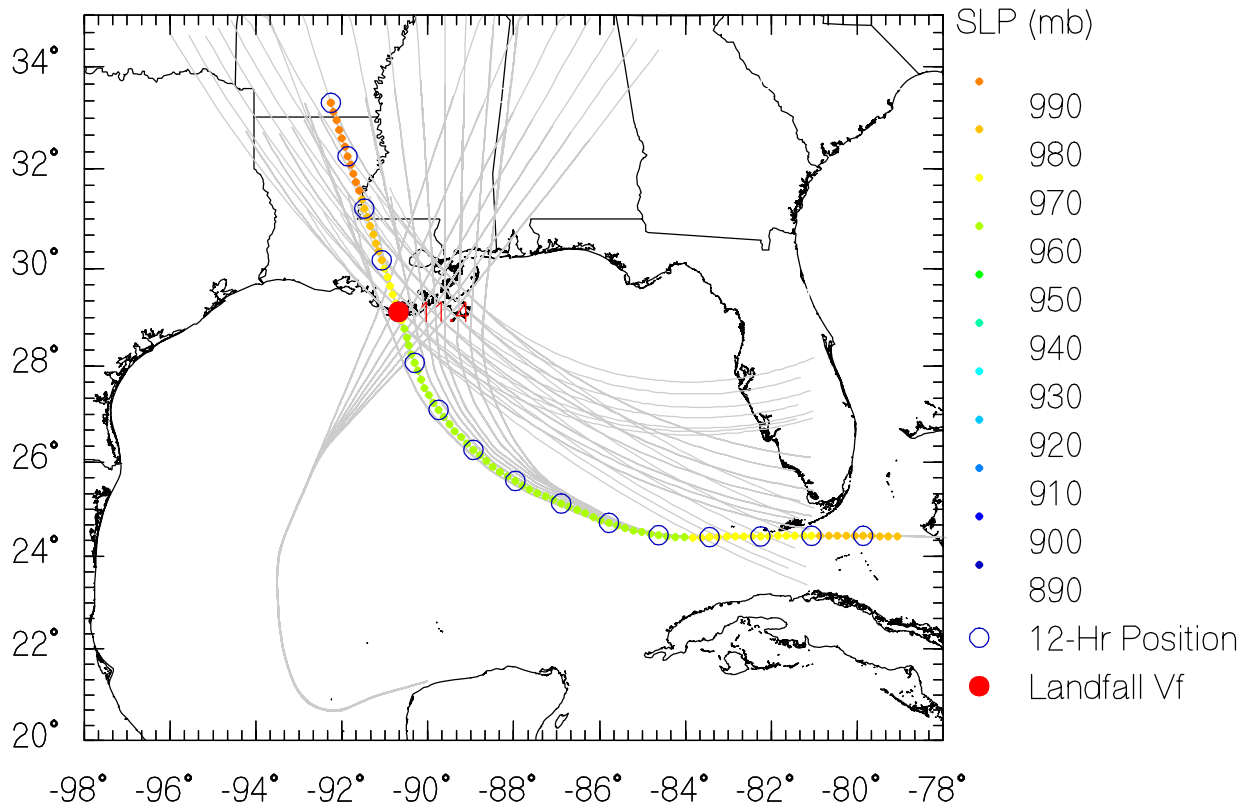

JRUN116 Data

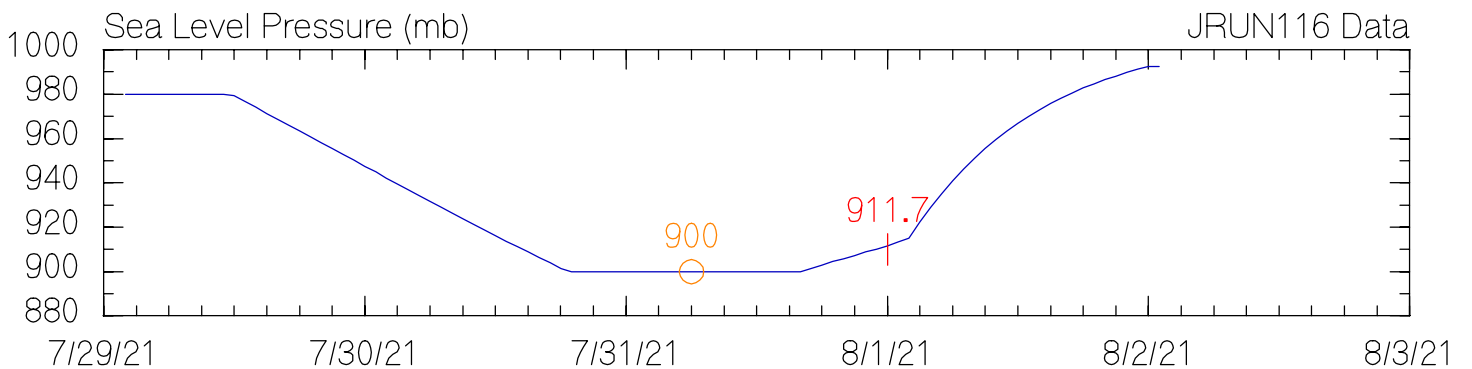
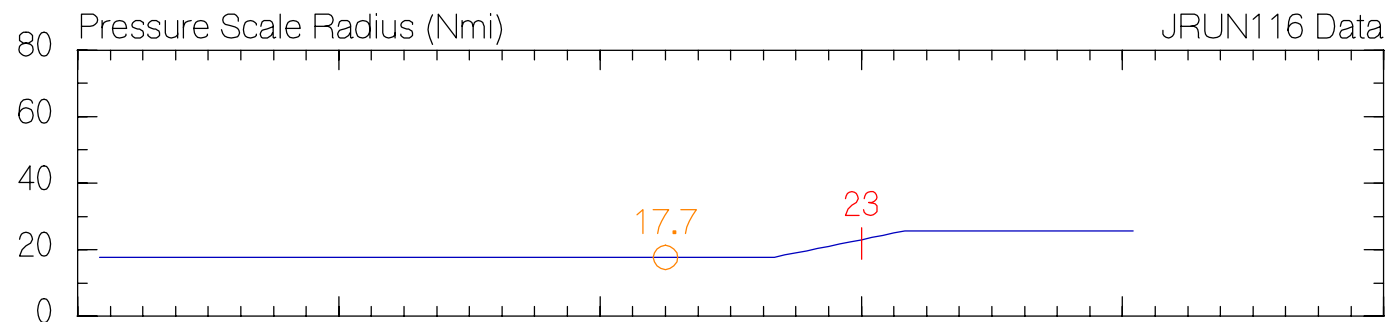
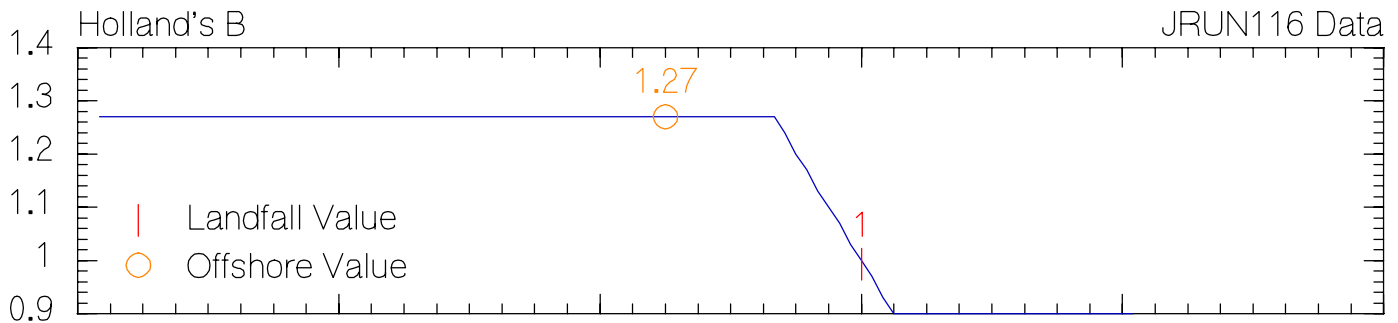
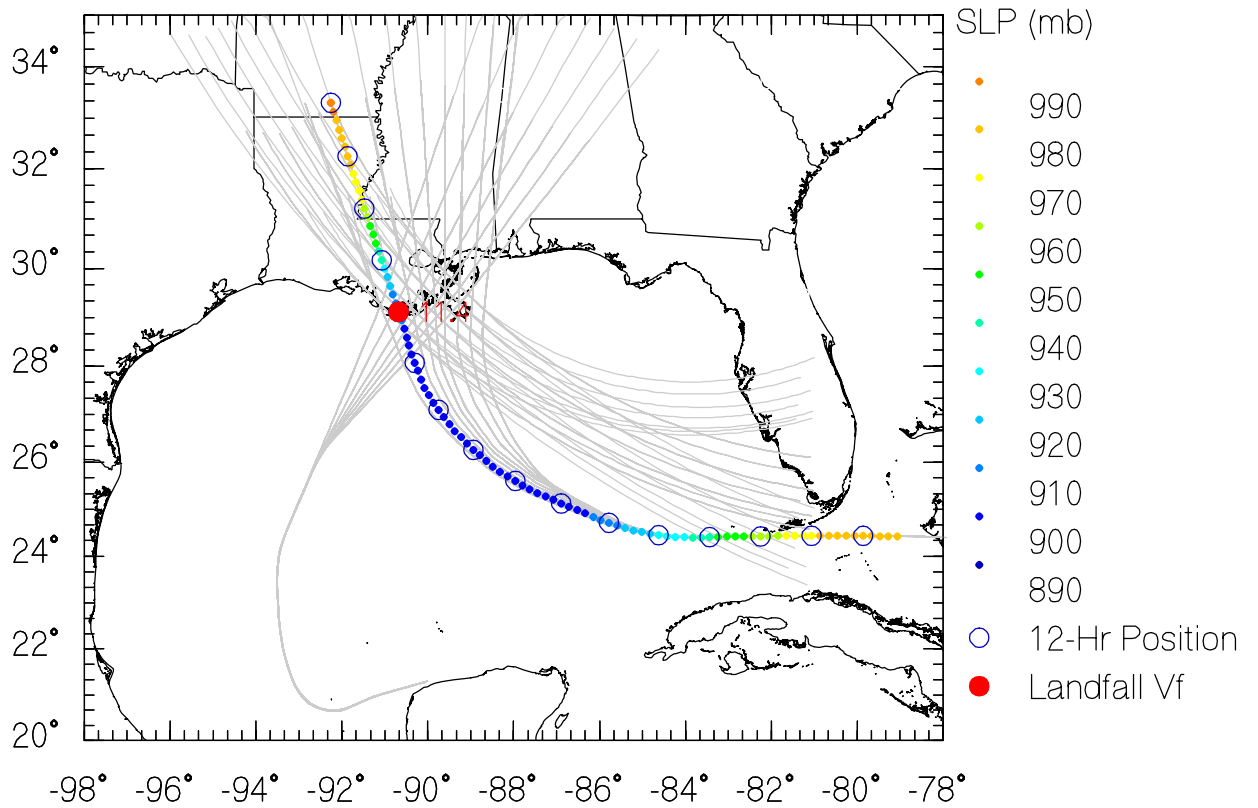

JRUN117 Data

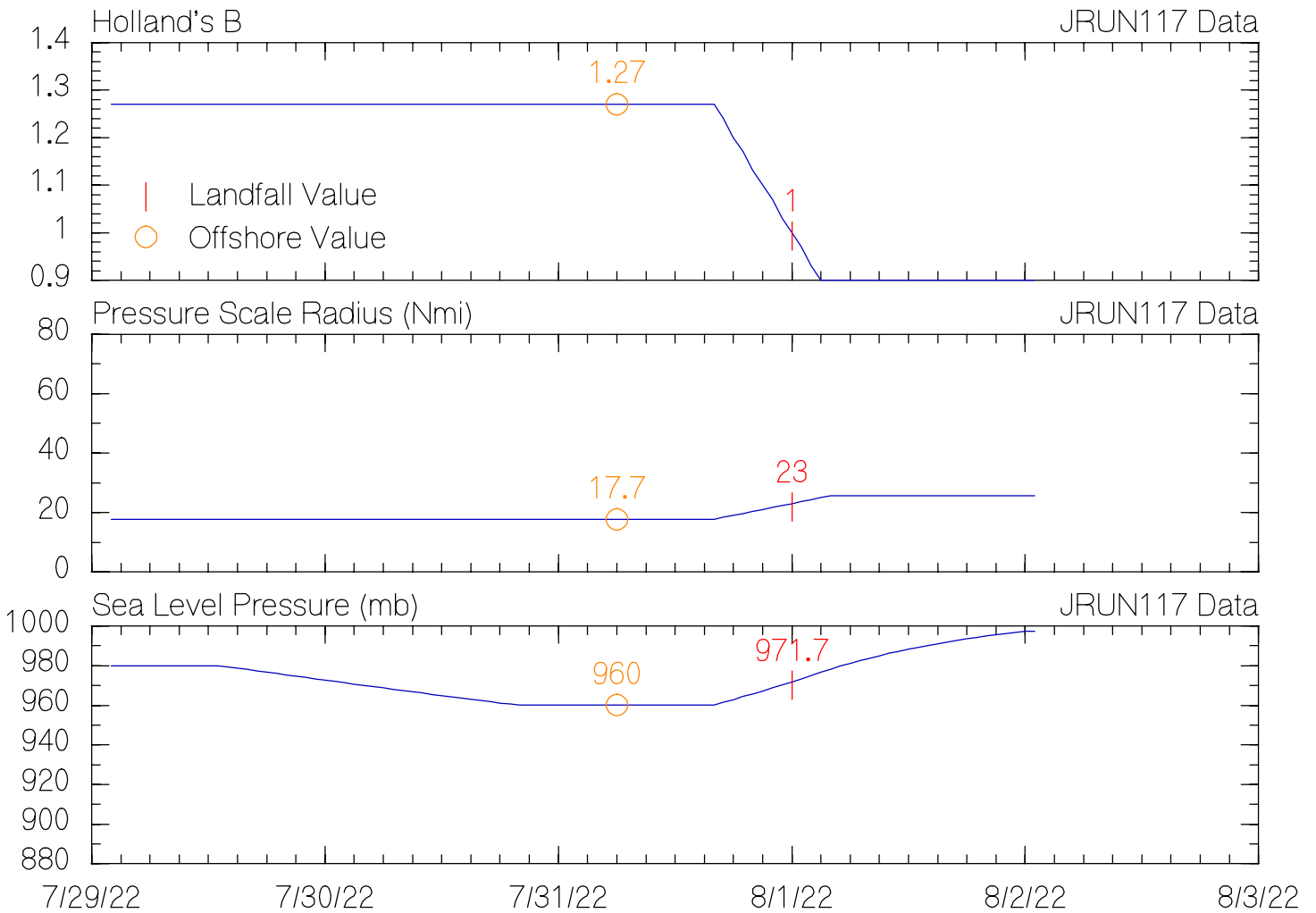
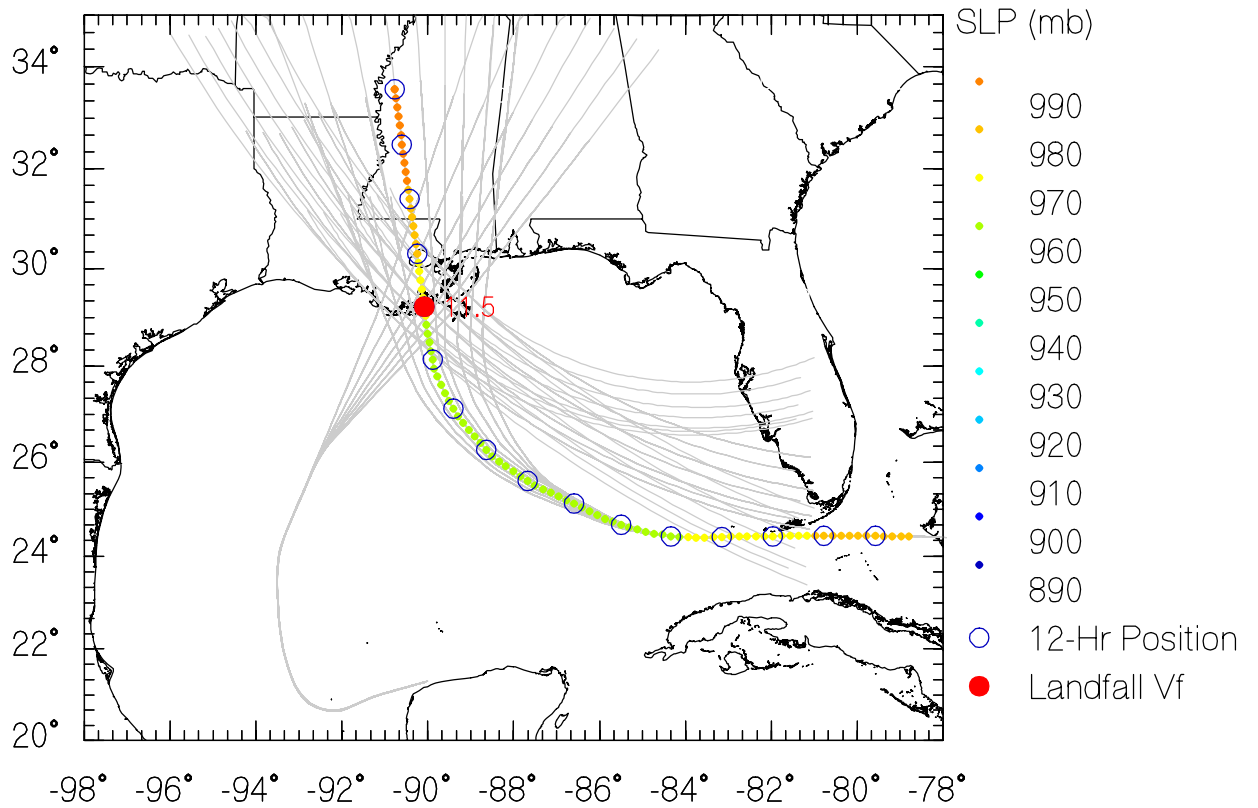

JRUN118 Data

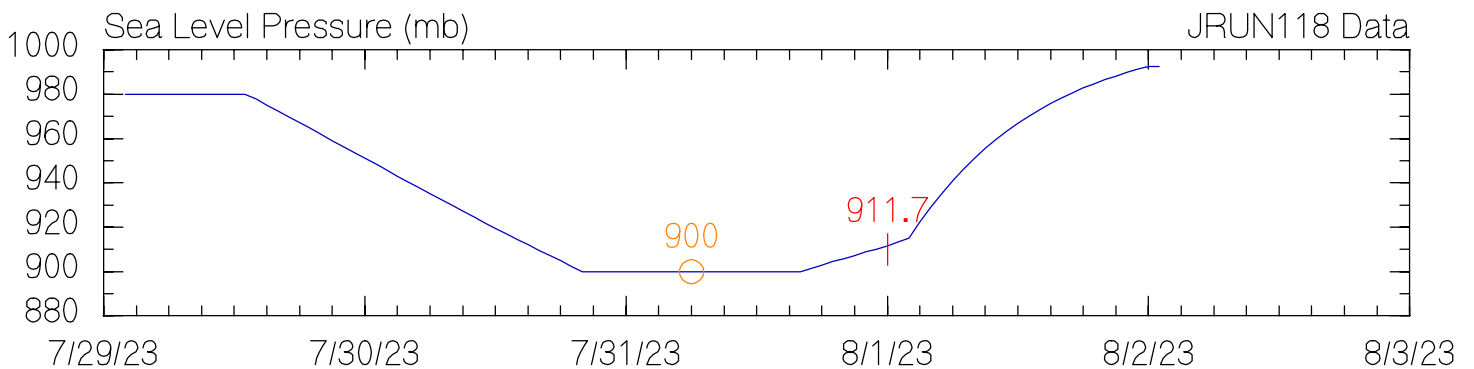
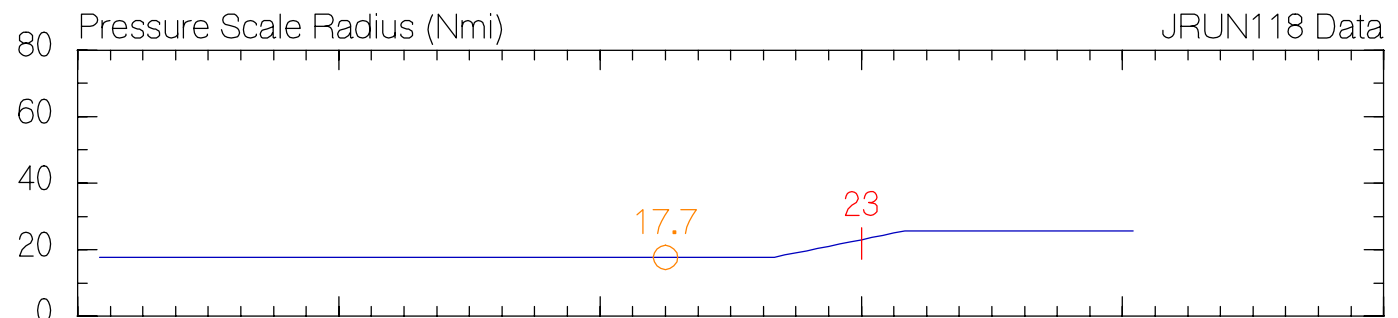
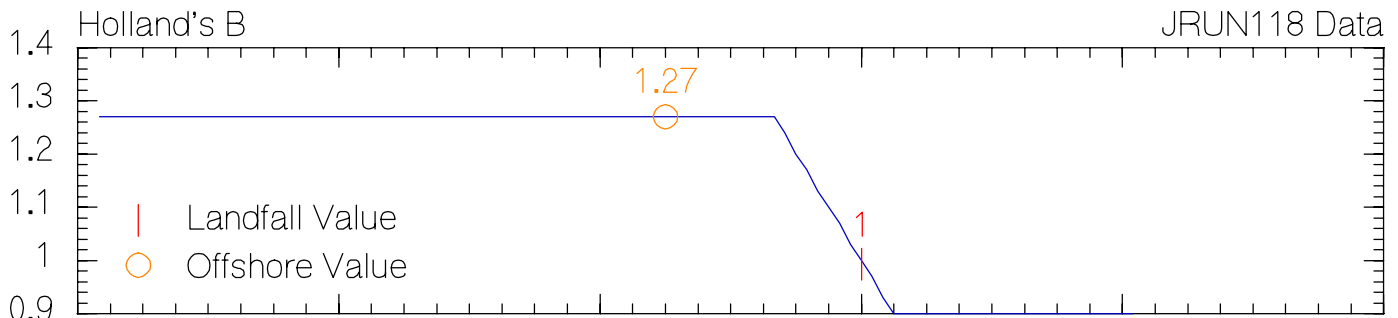
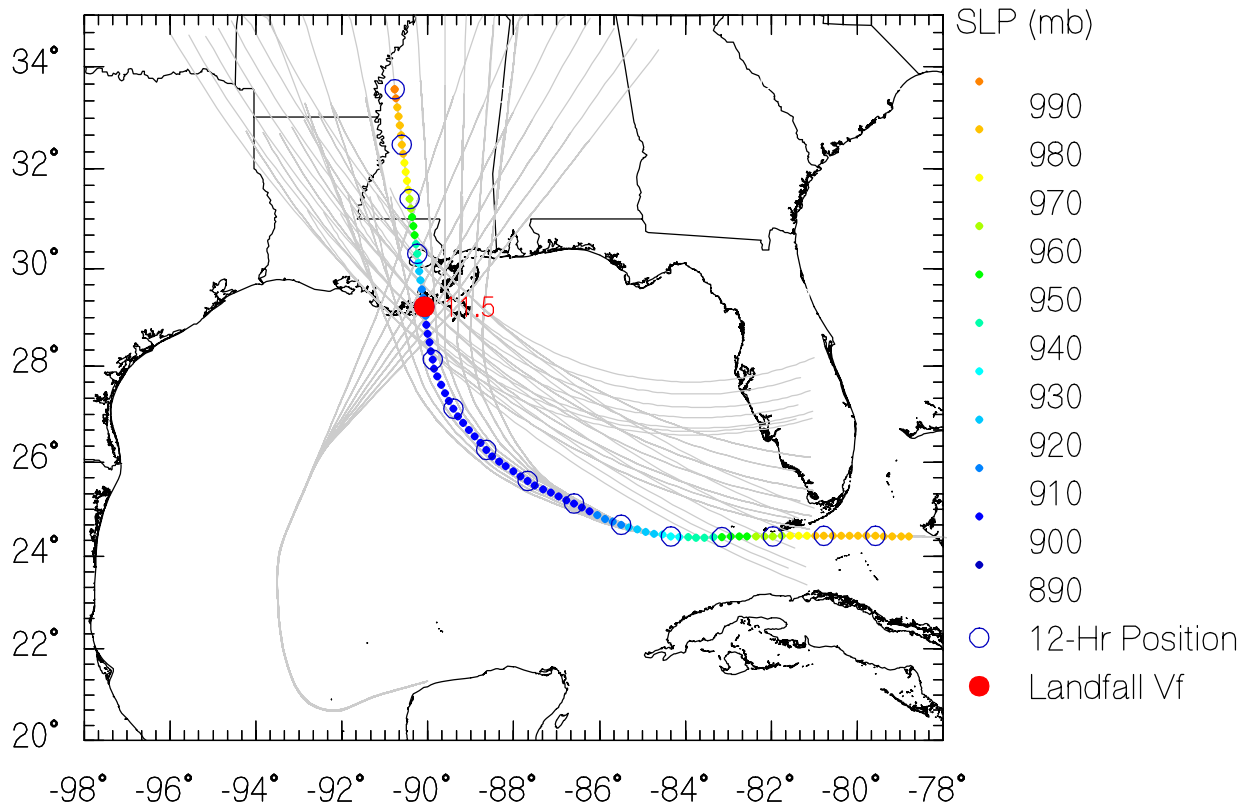

JRUN119 Data

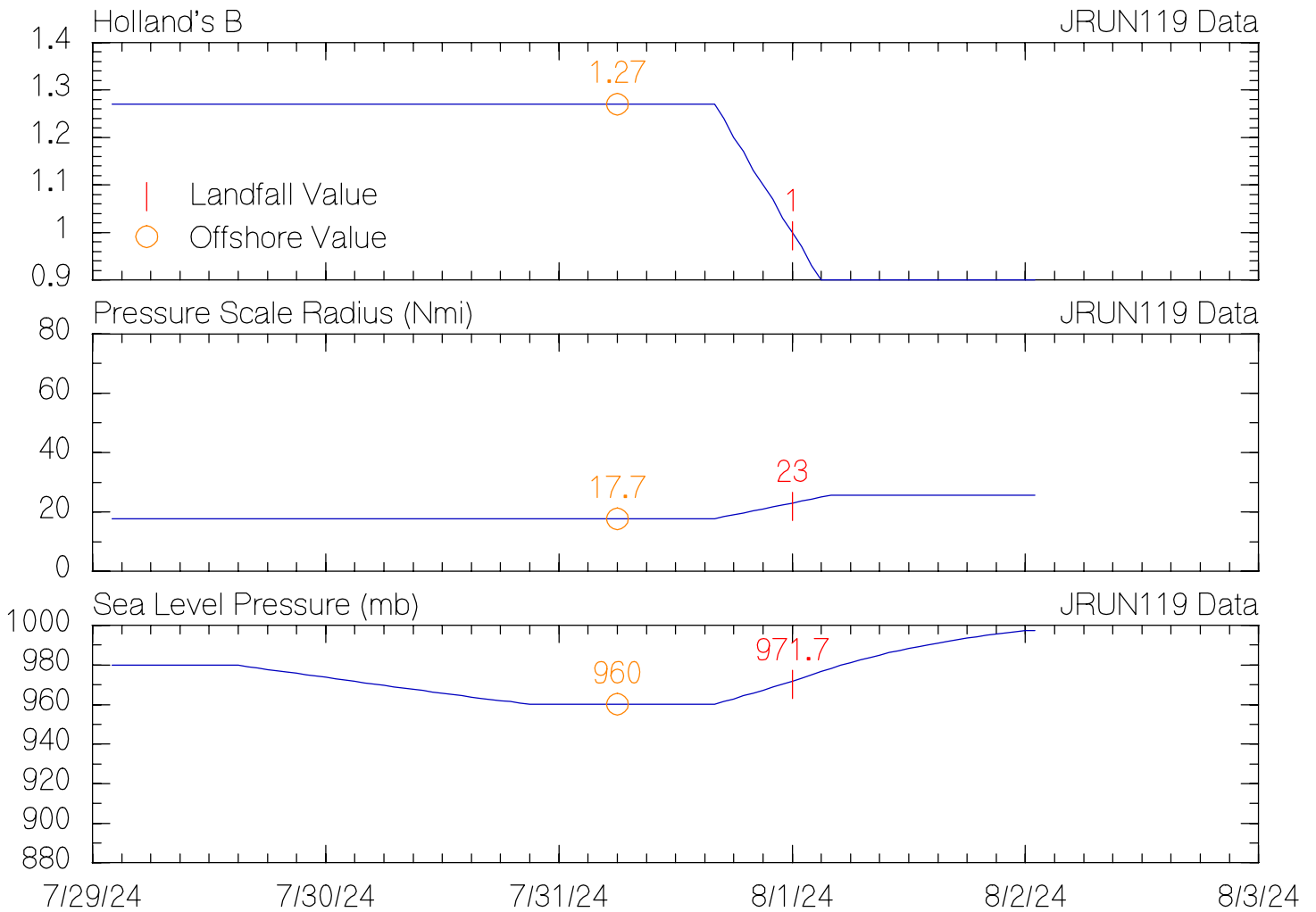
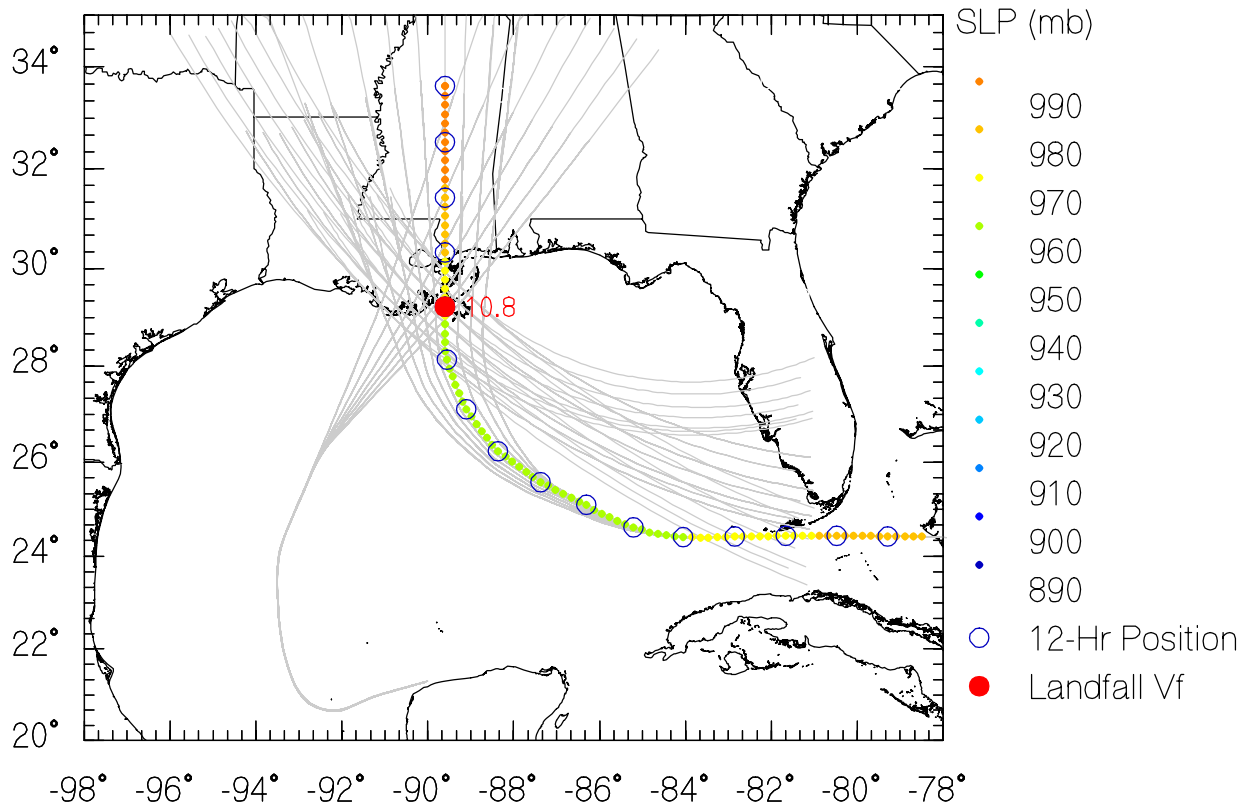

JRUN120 Data

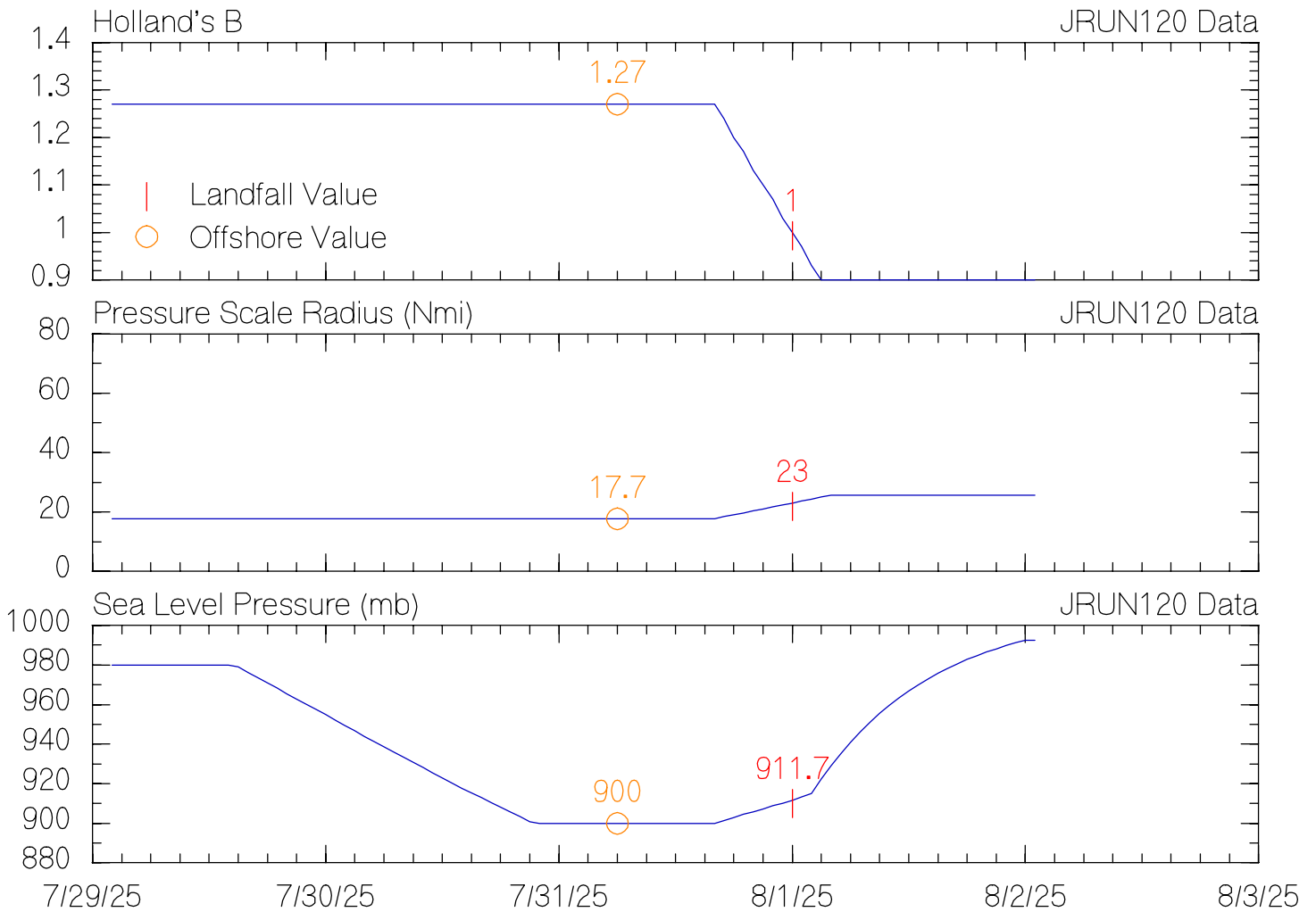
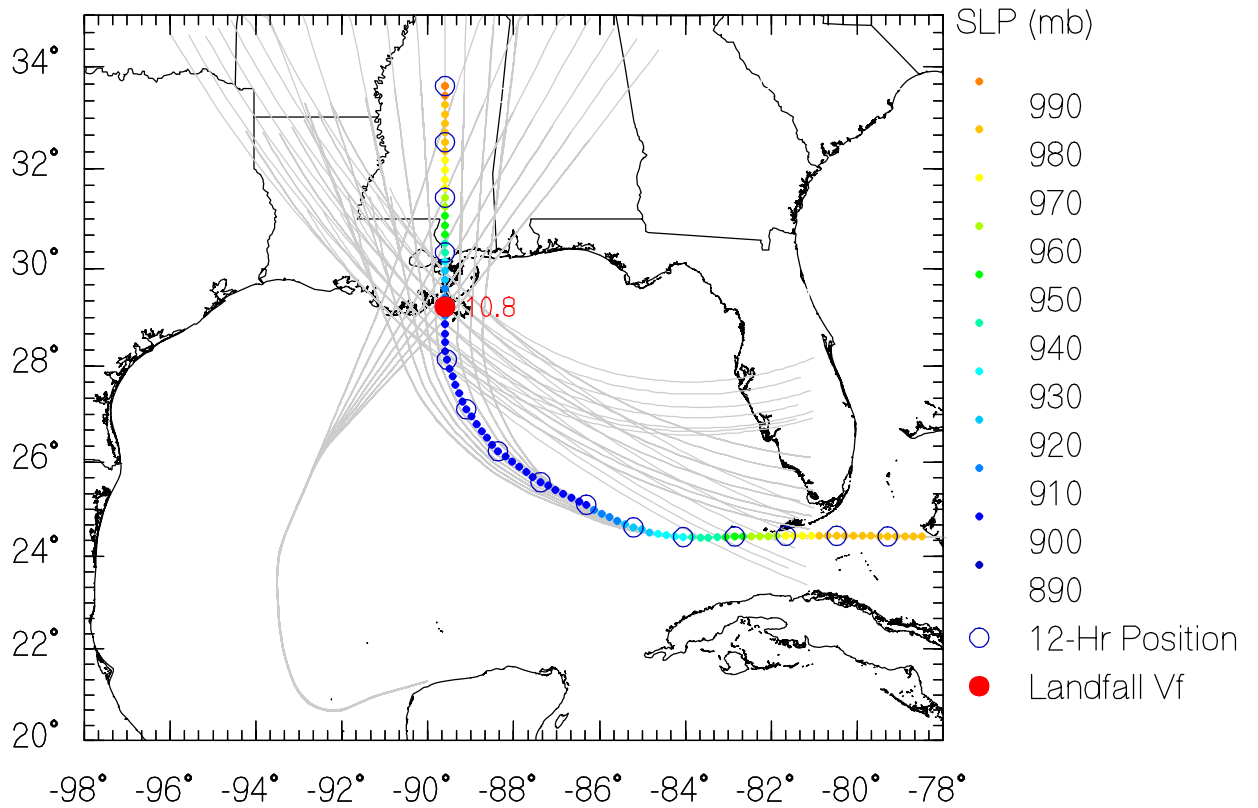

JRUN121 Data

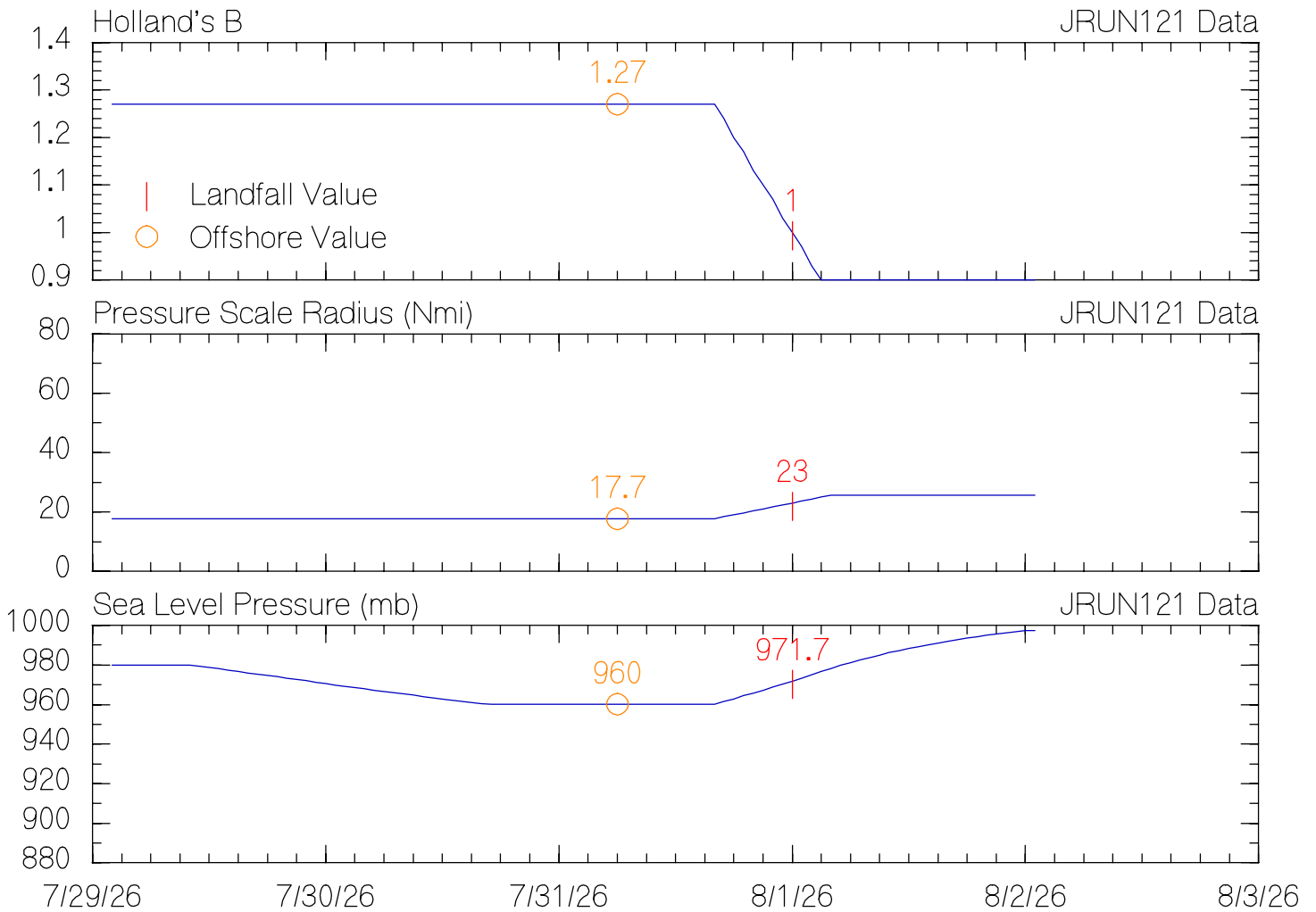
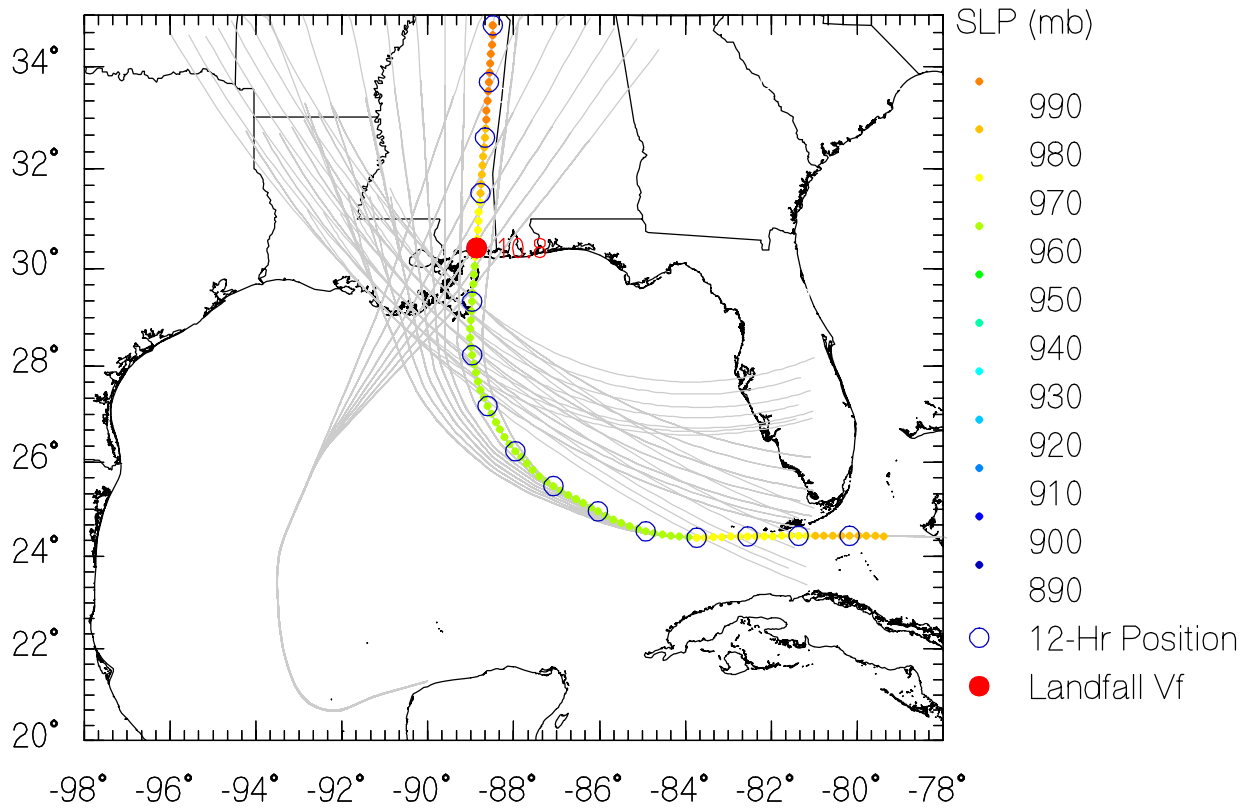

JRUN122 Data

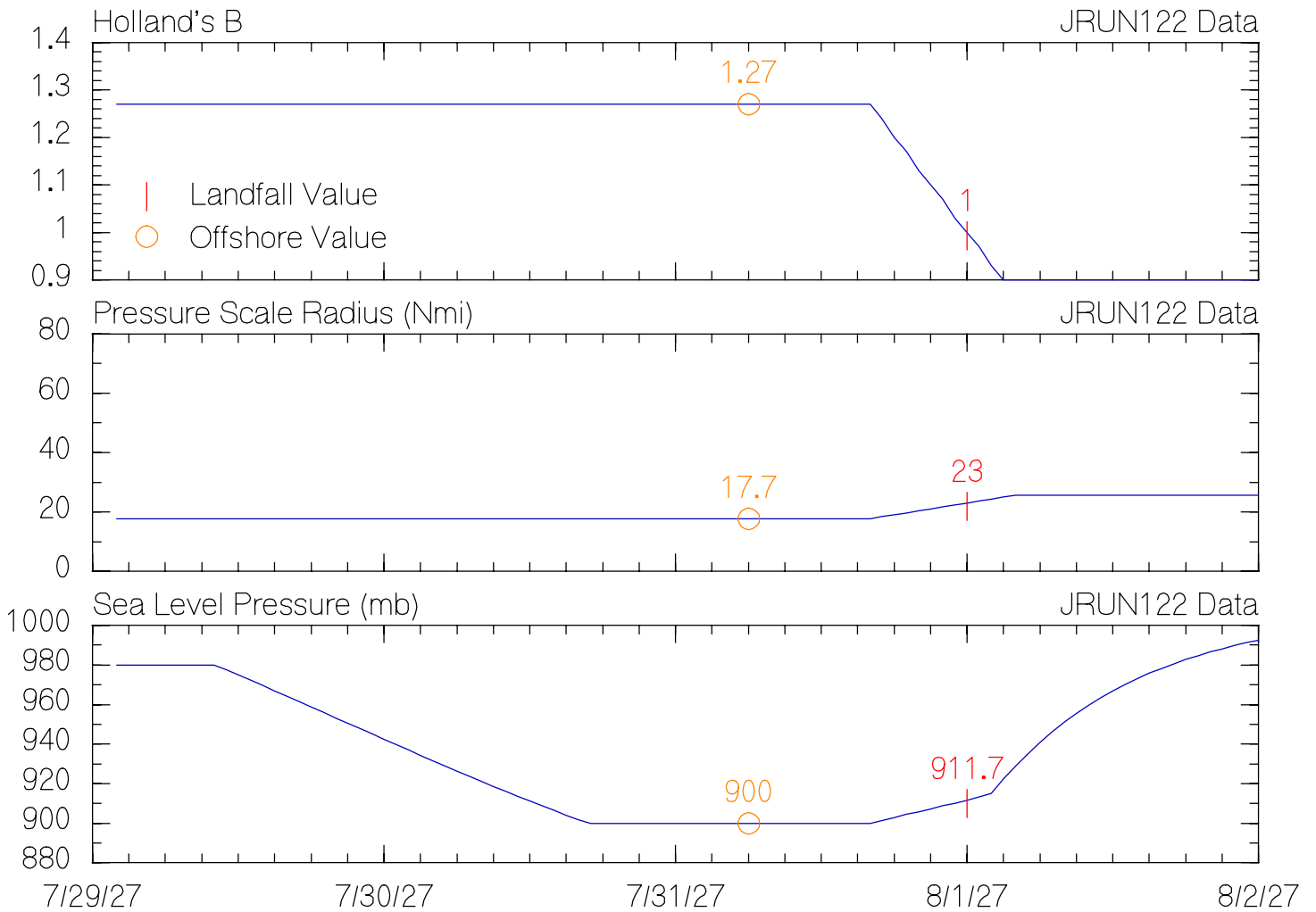
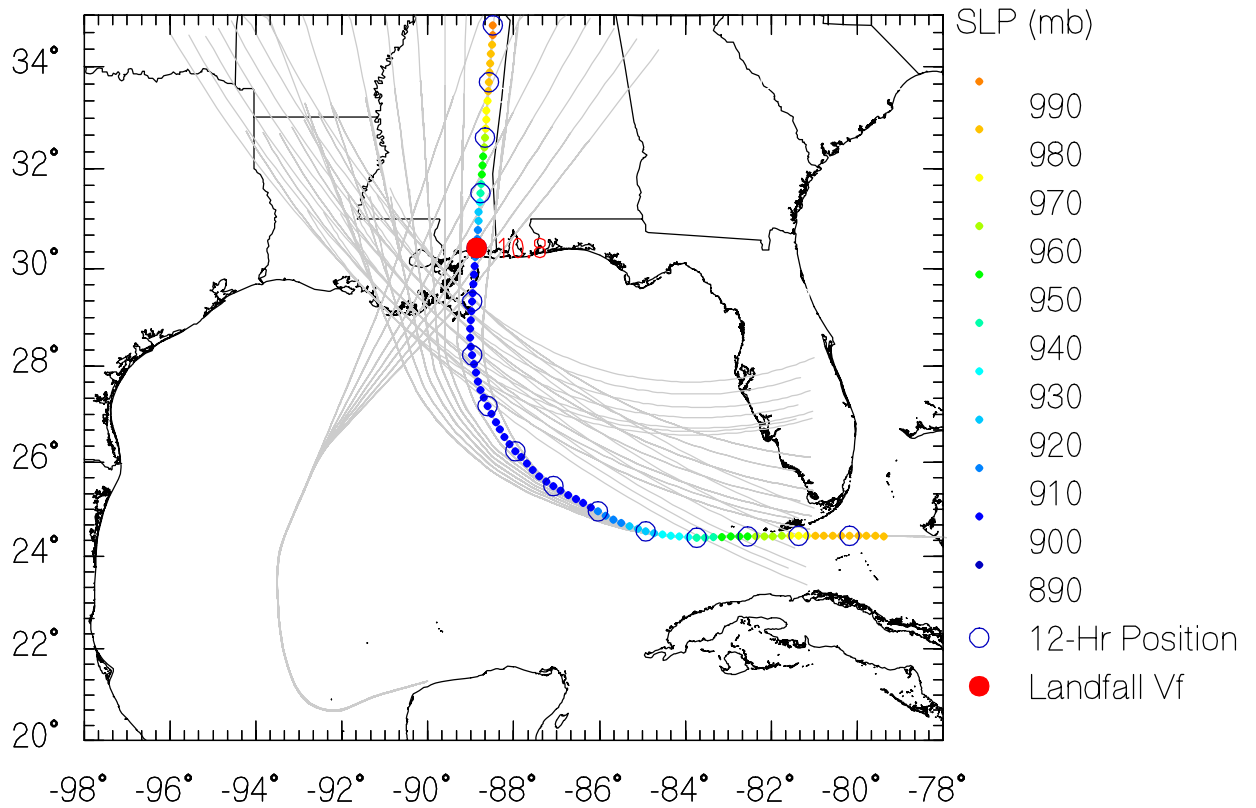

JRUN123 Data

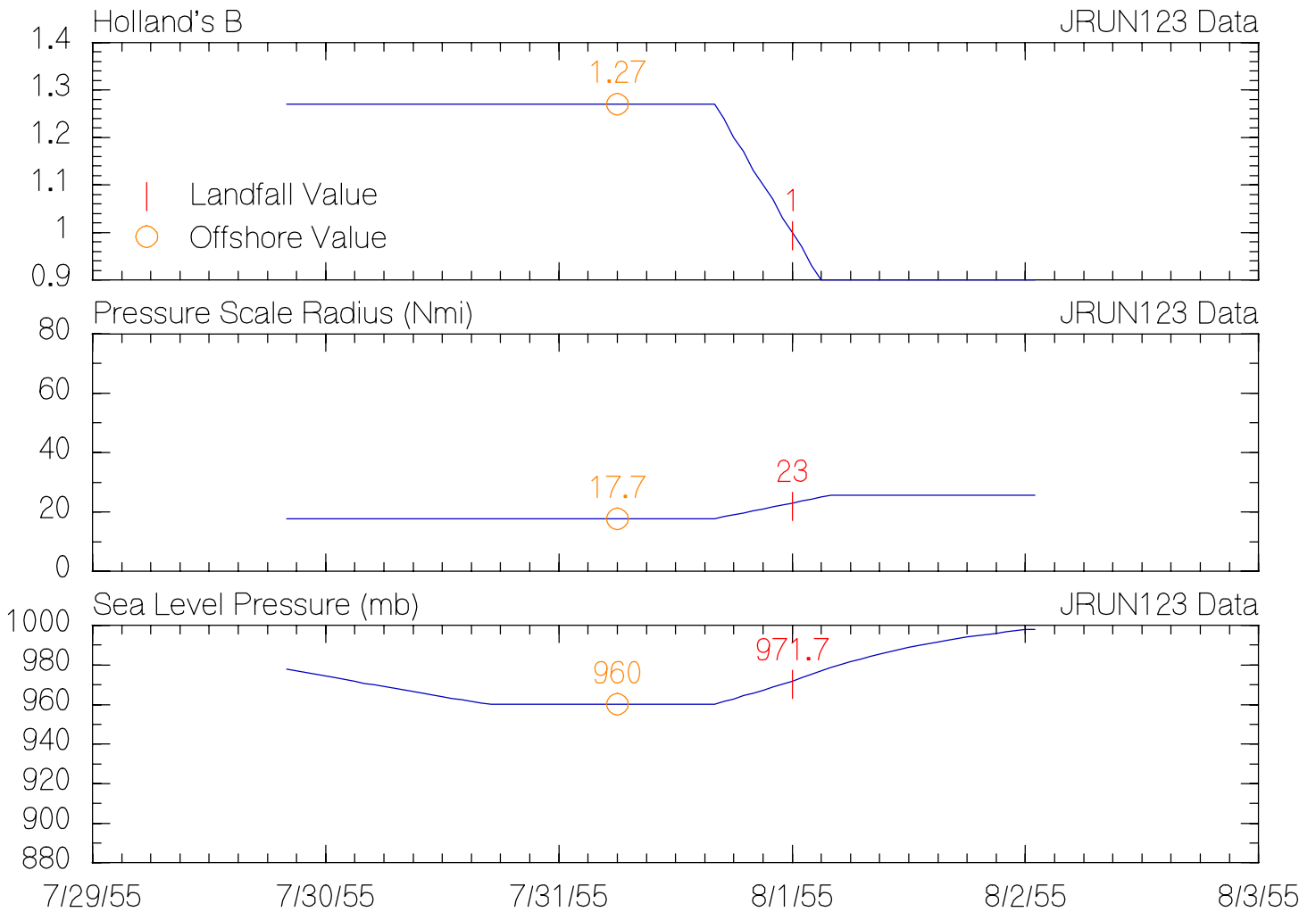
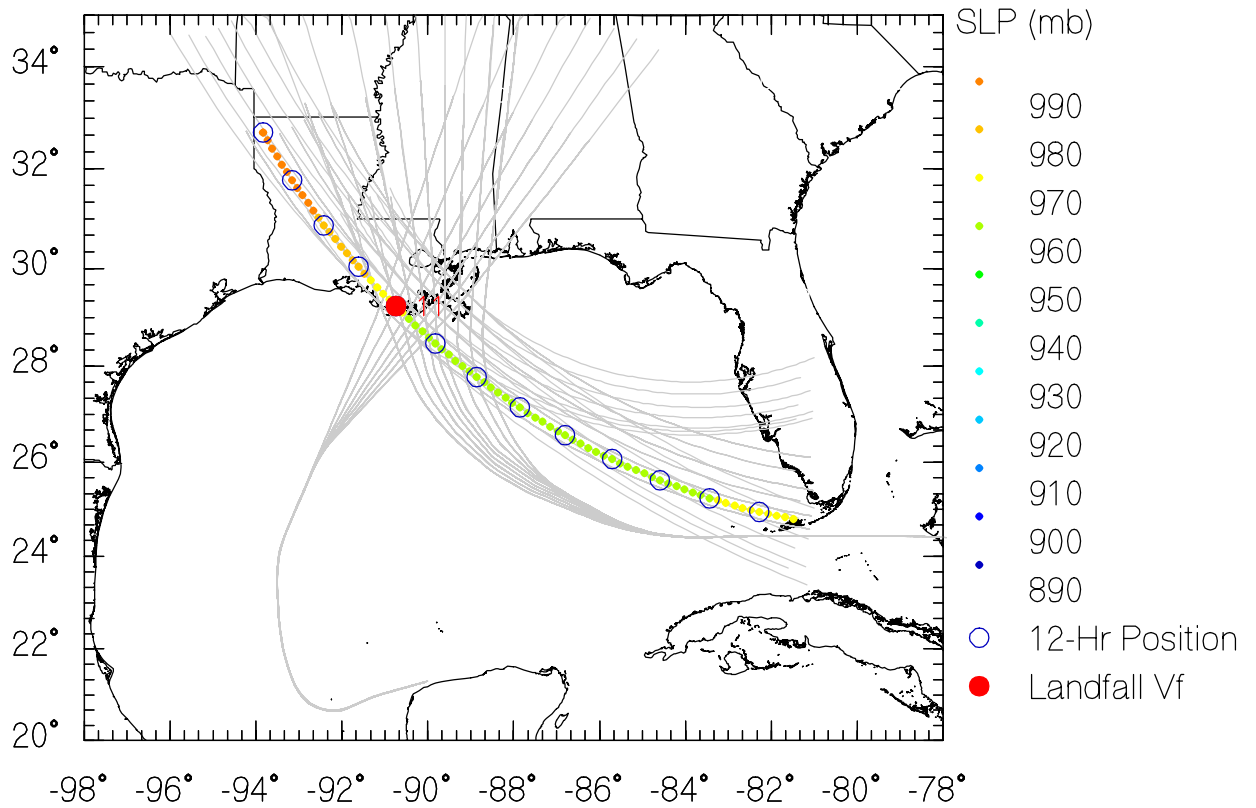

JRUN124 Data

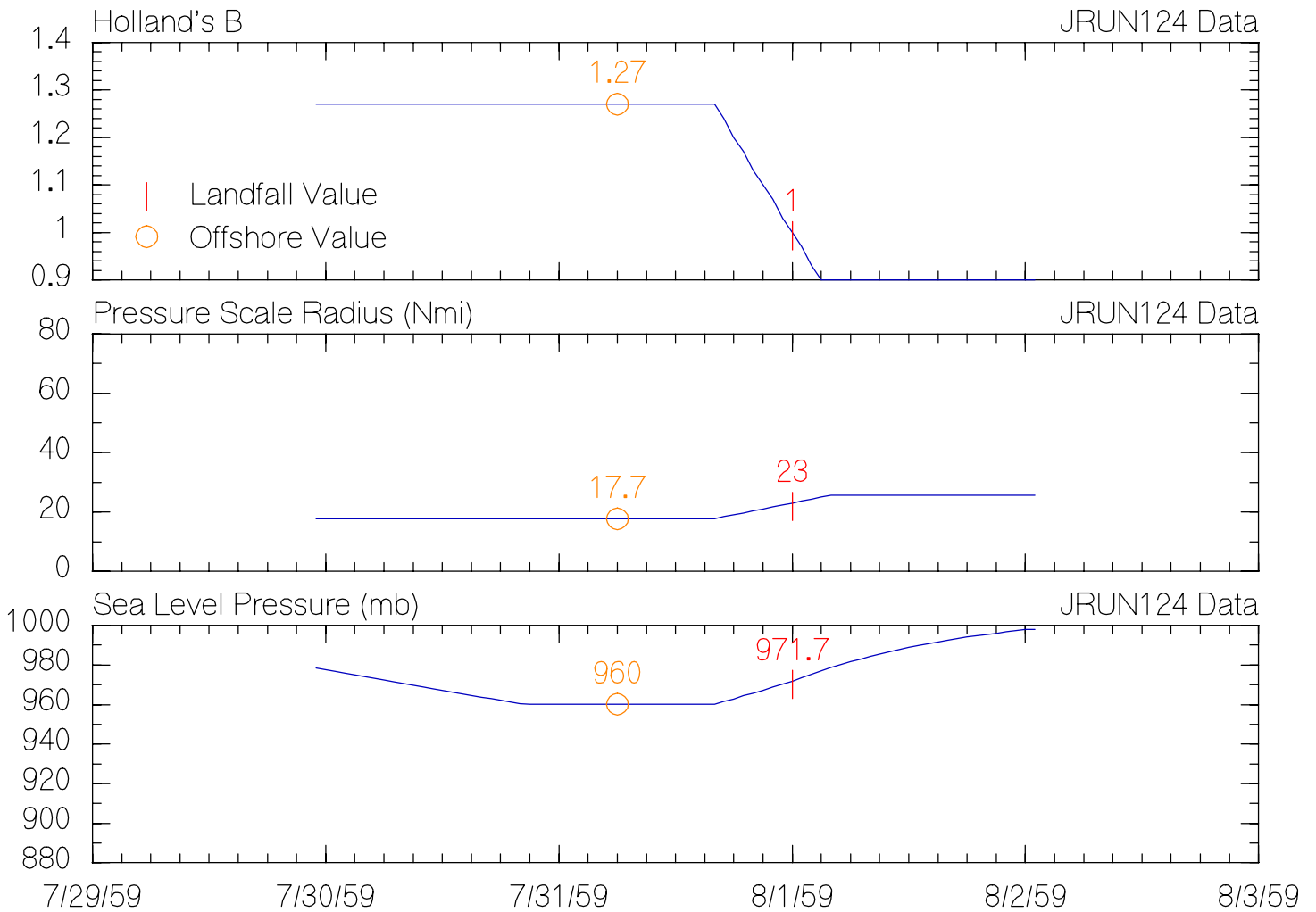
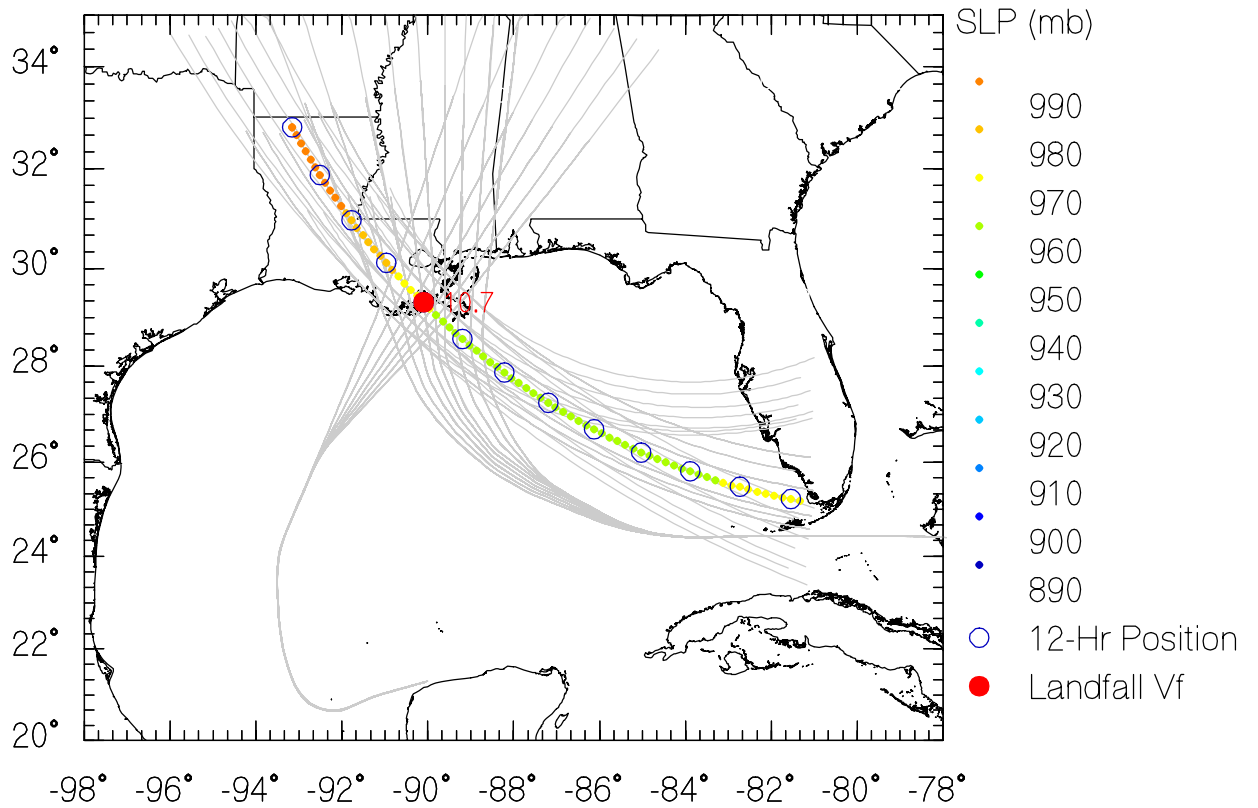

JRUN125 Data

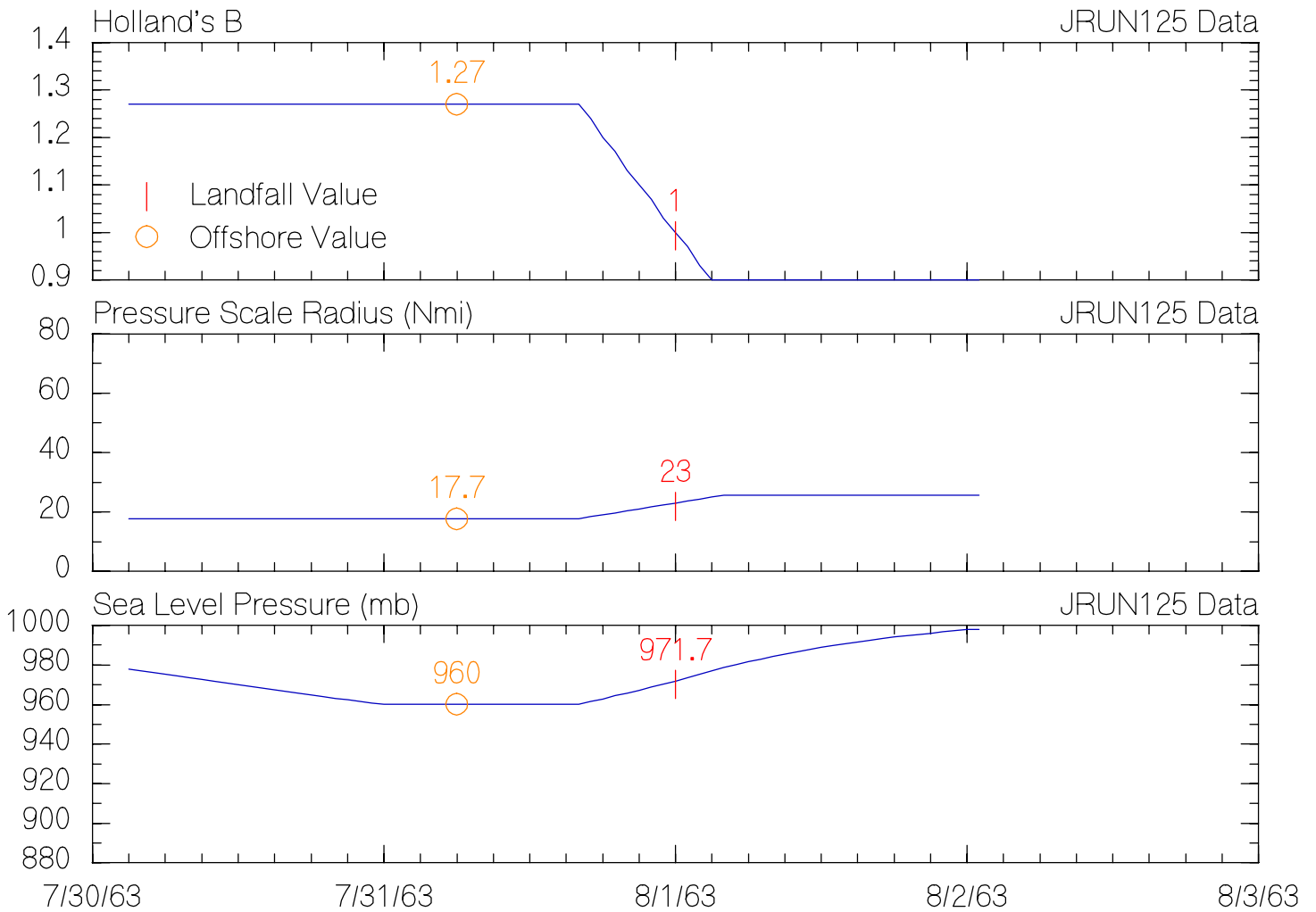
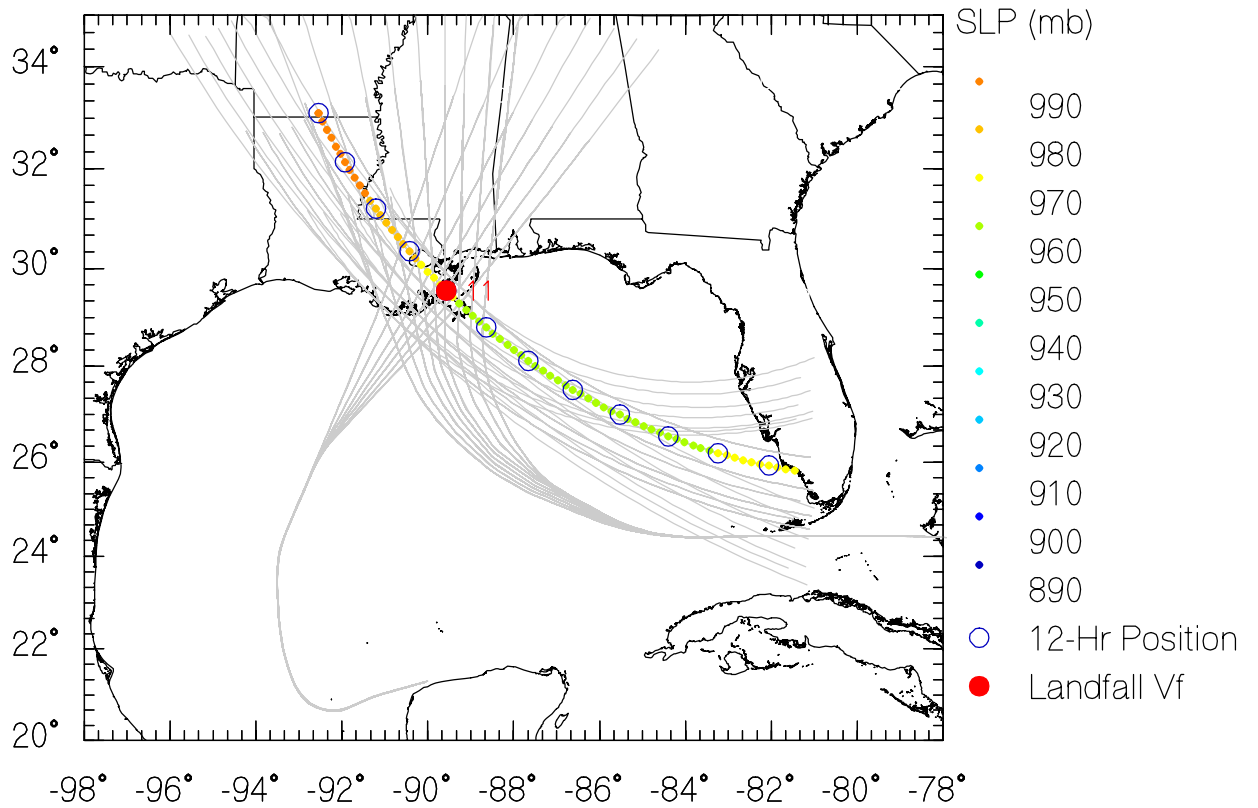

JRUN126 Data

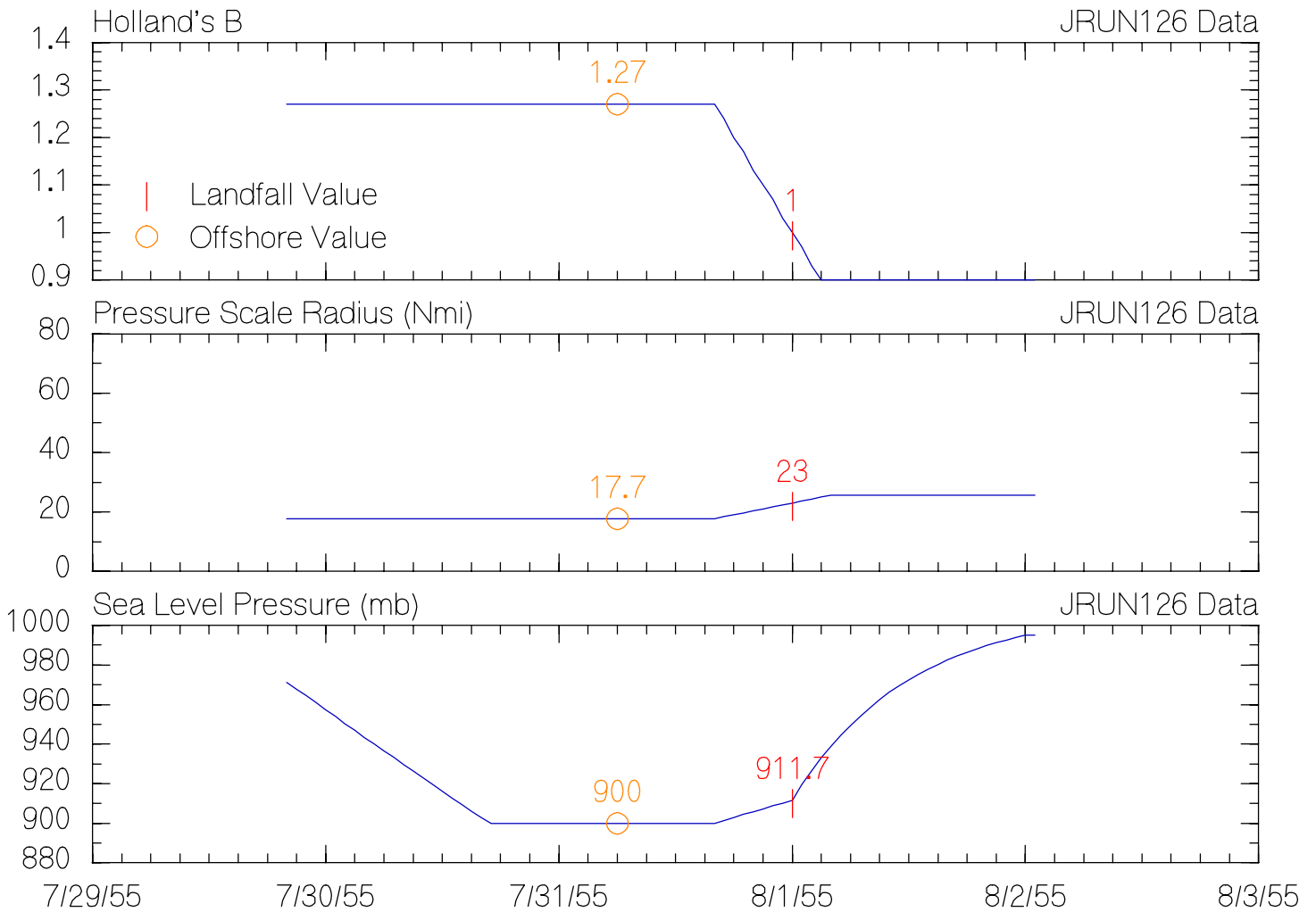
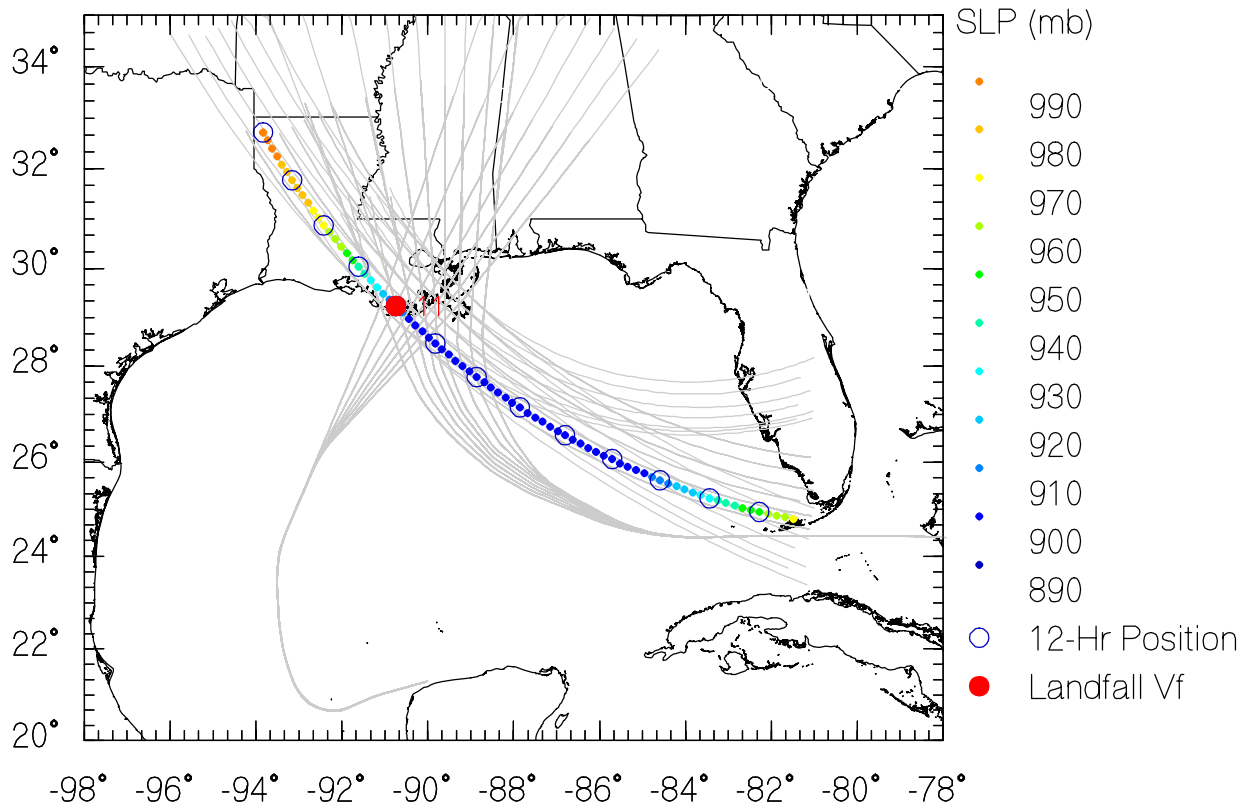

JRUN127 Data

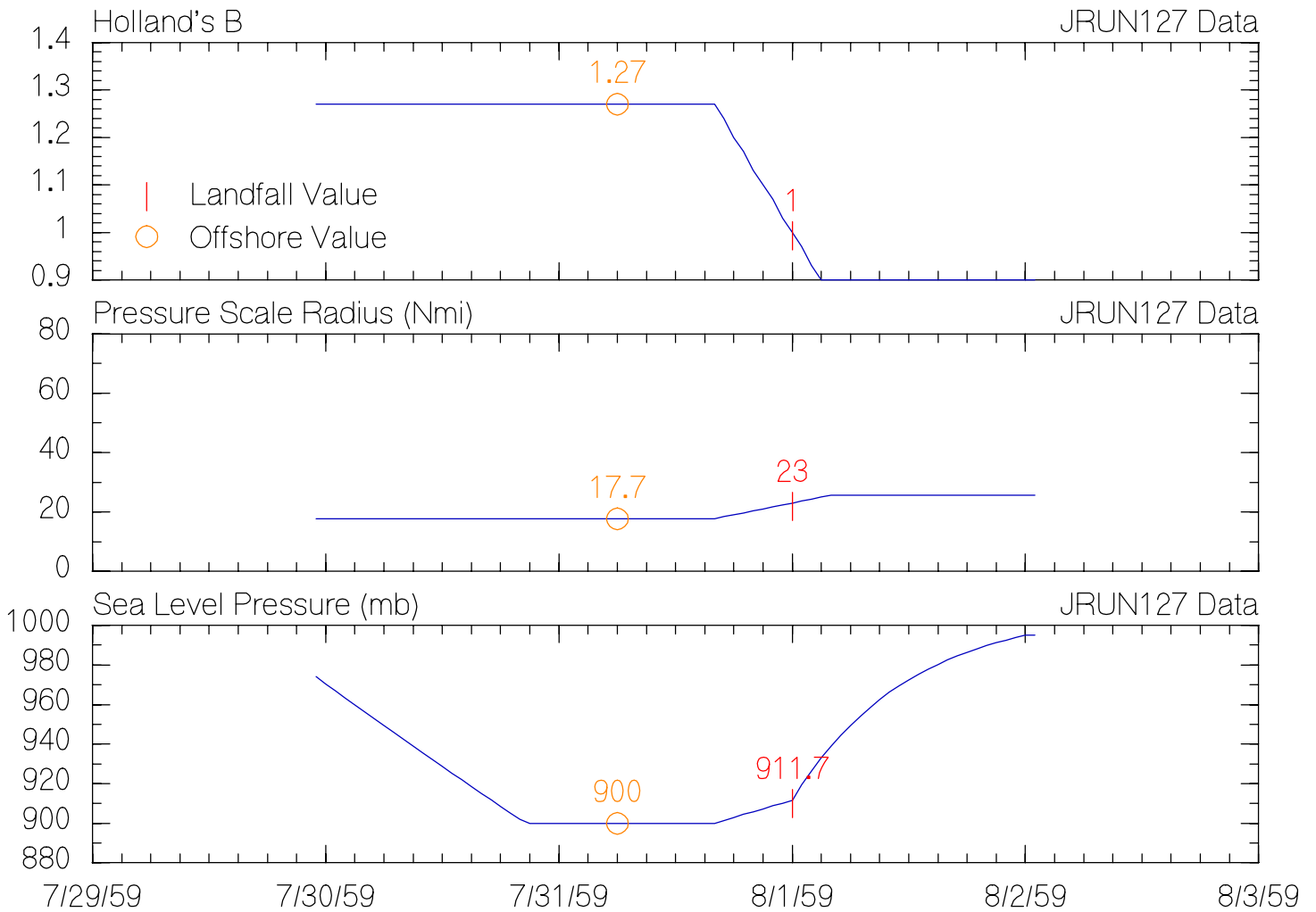
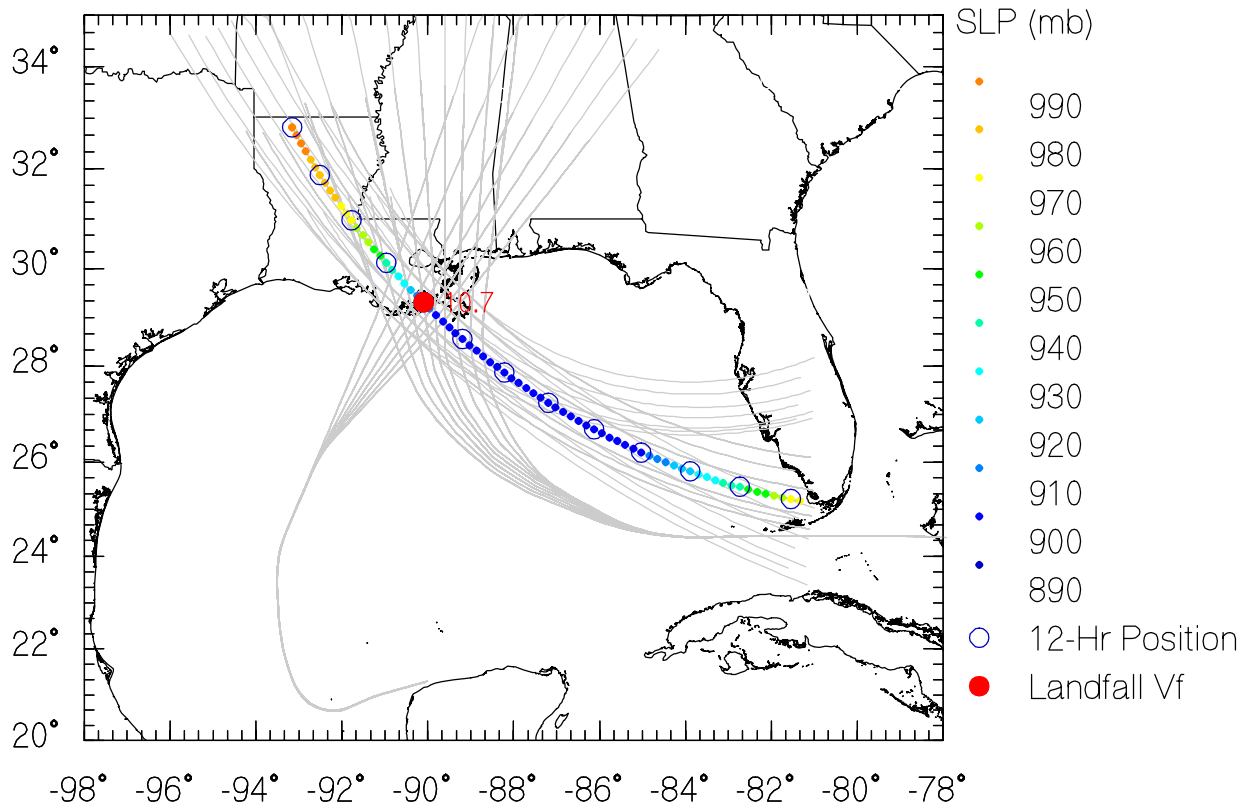

JRUN128 Data

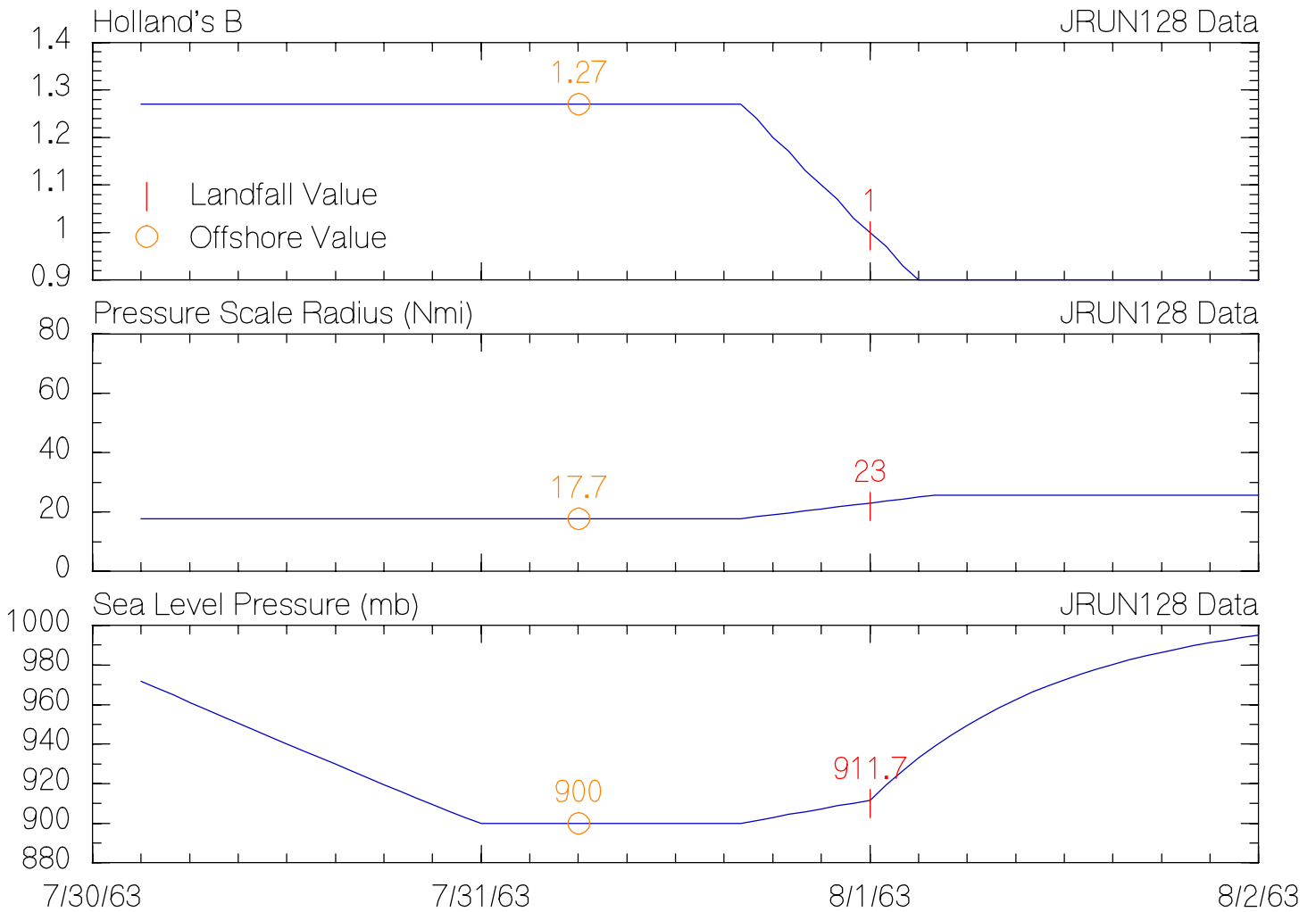
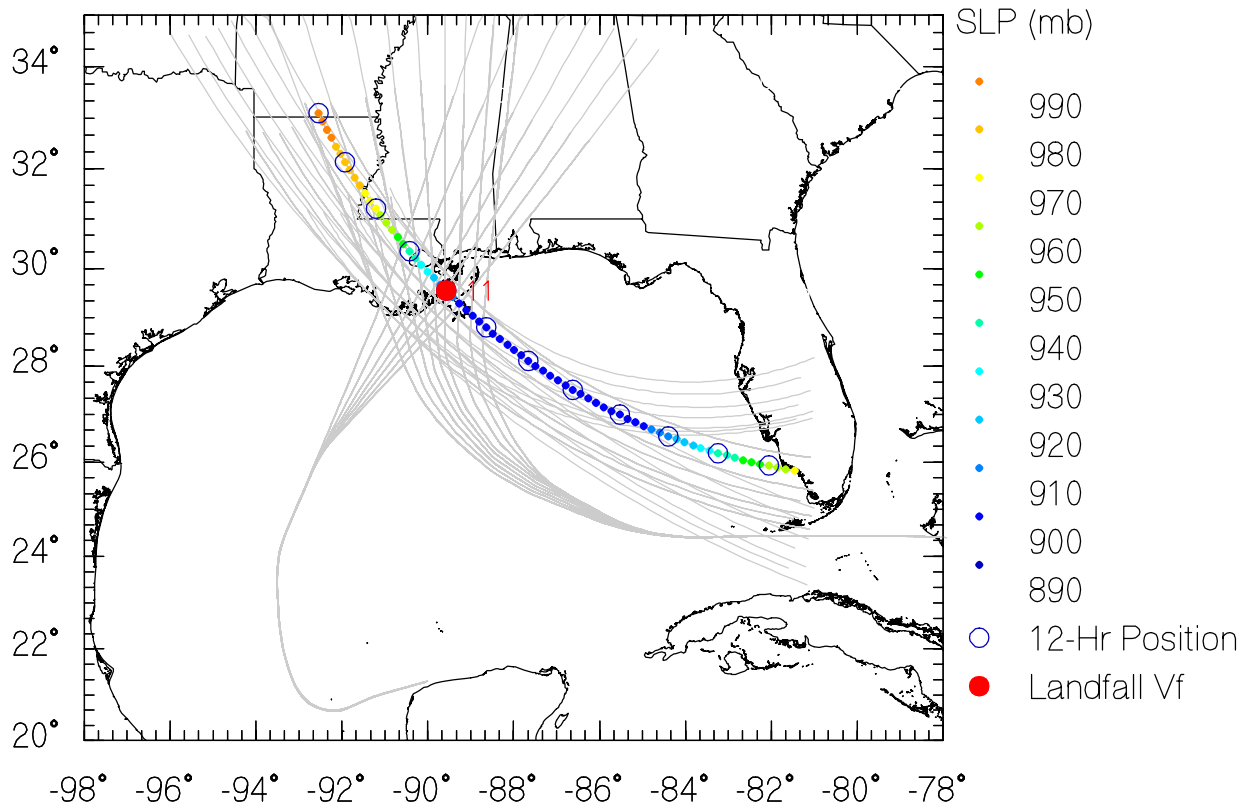

JRUN131 Data

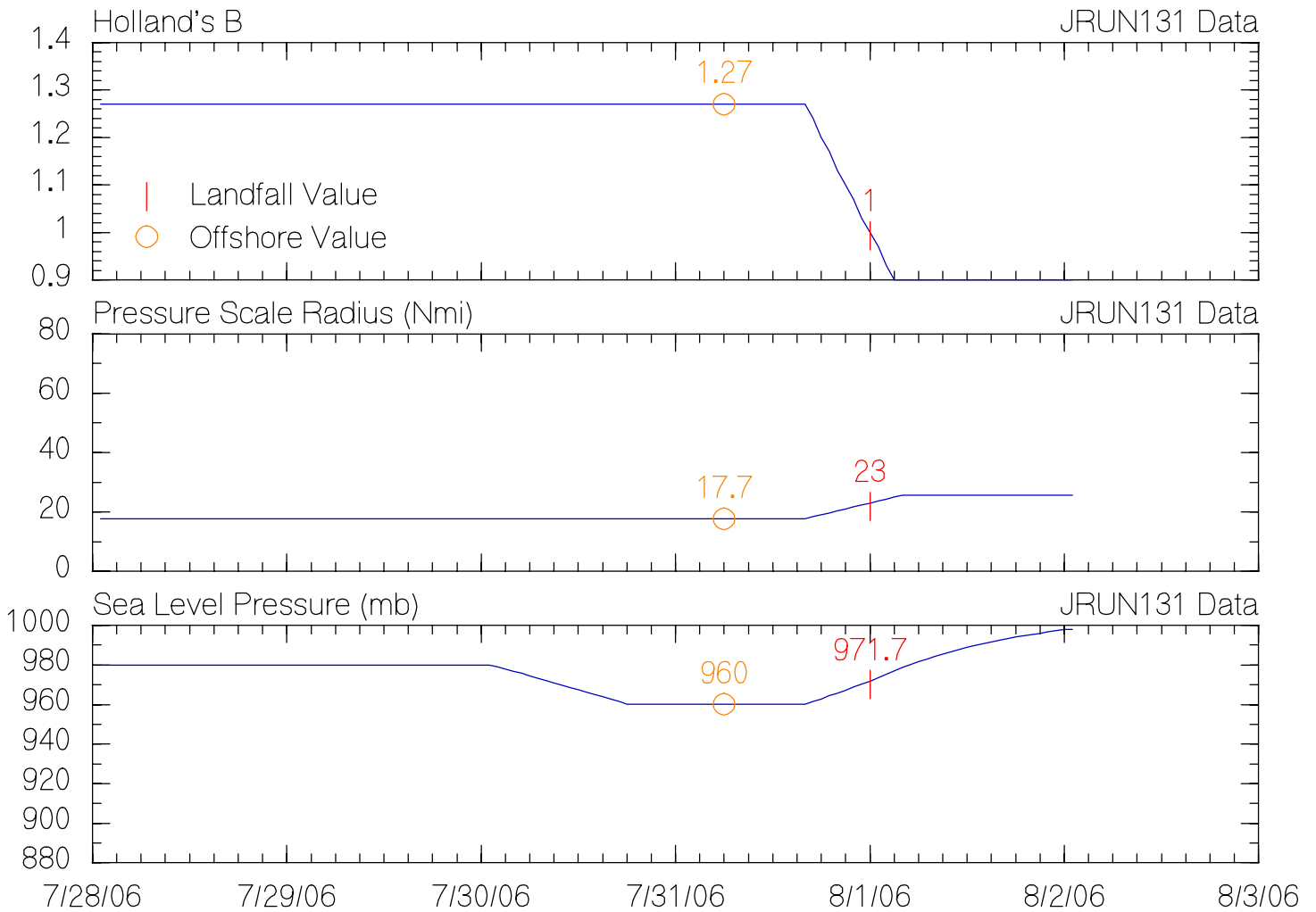
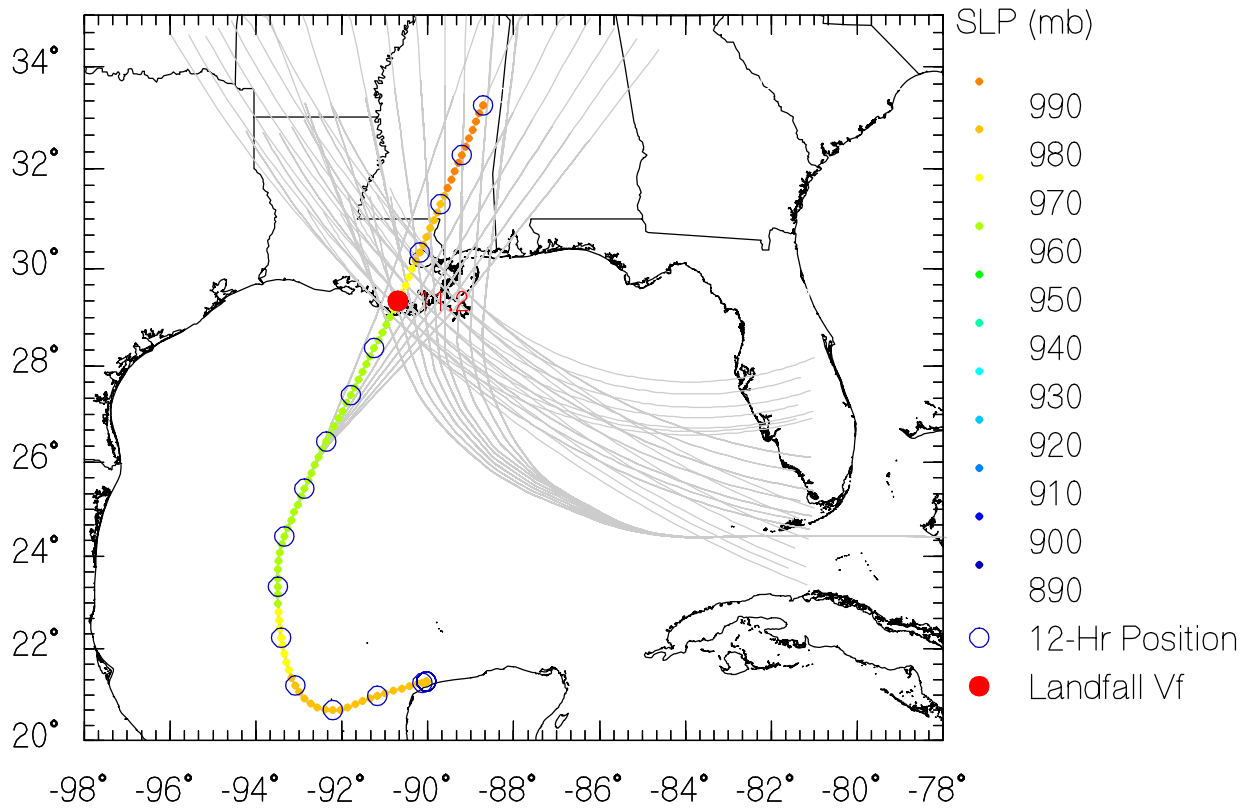

JRUN132 Data

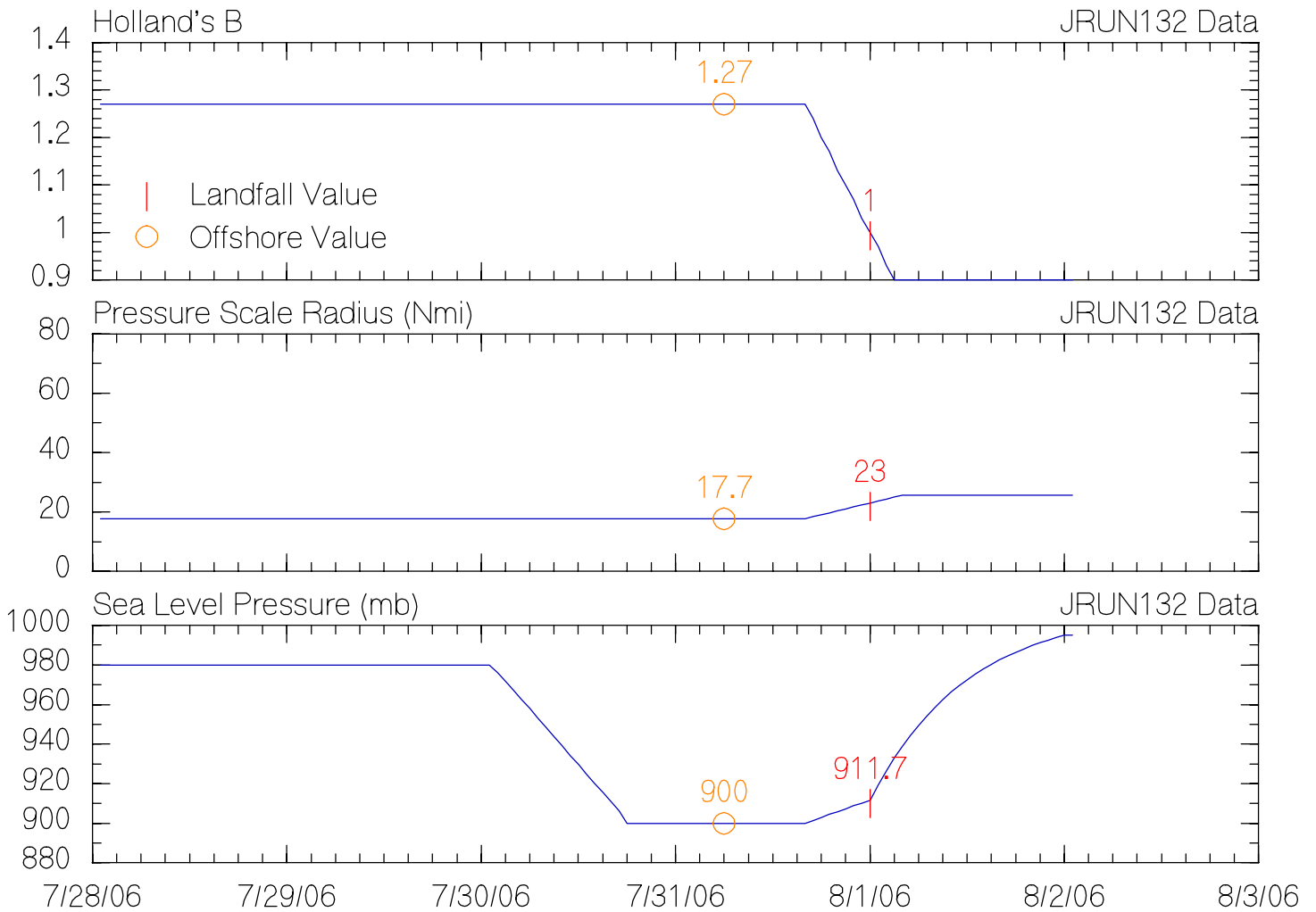
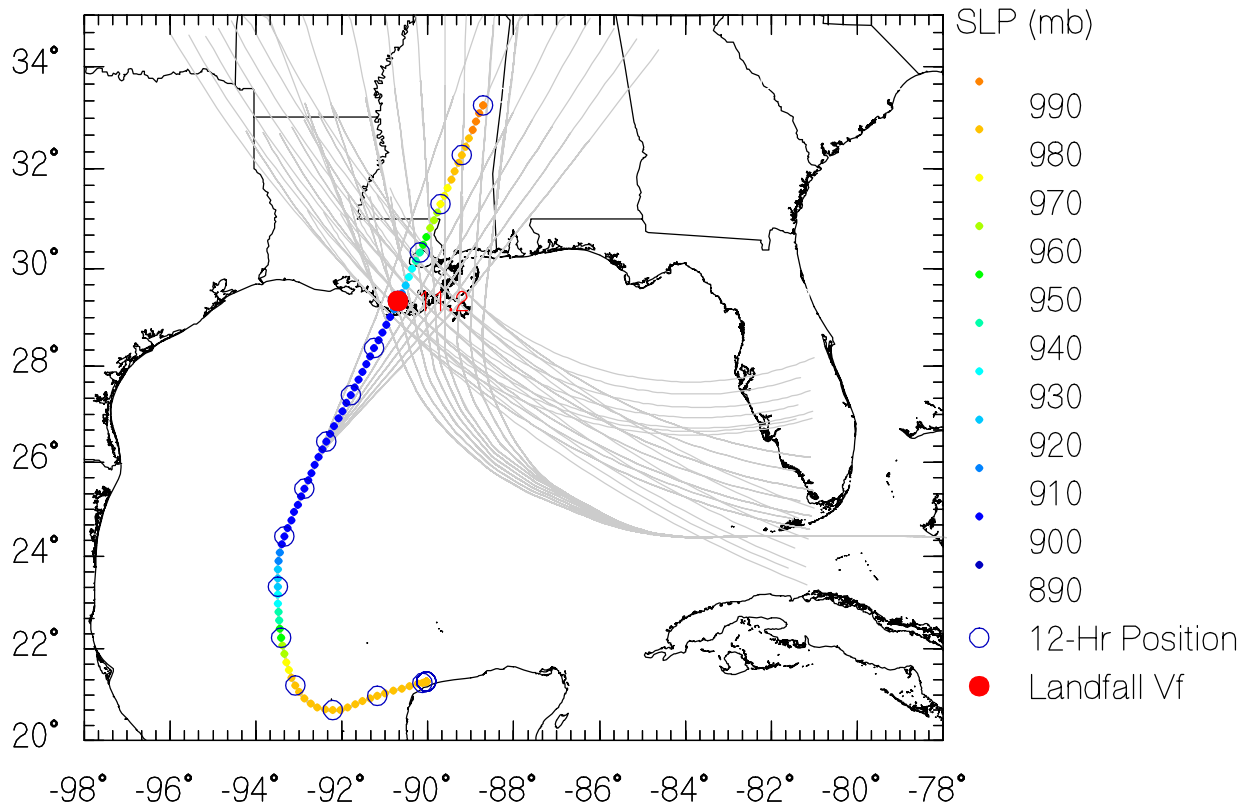

JRUN133 Data

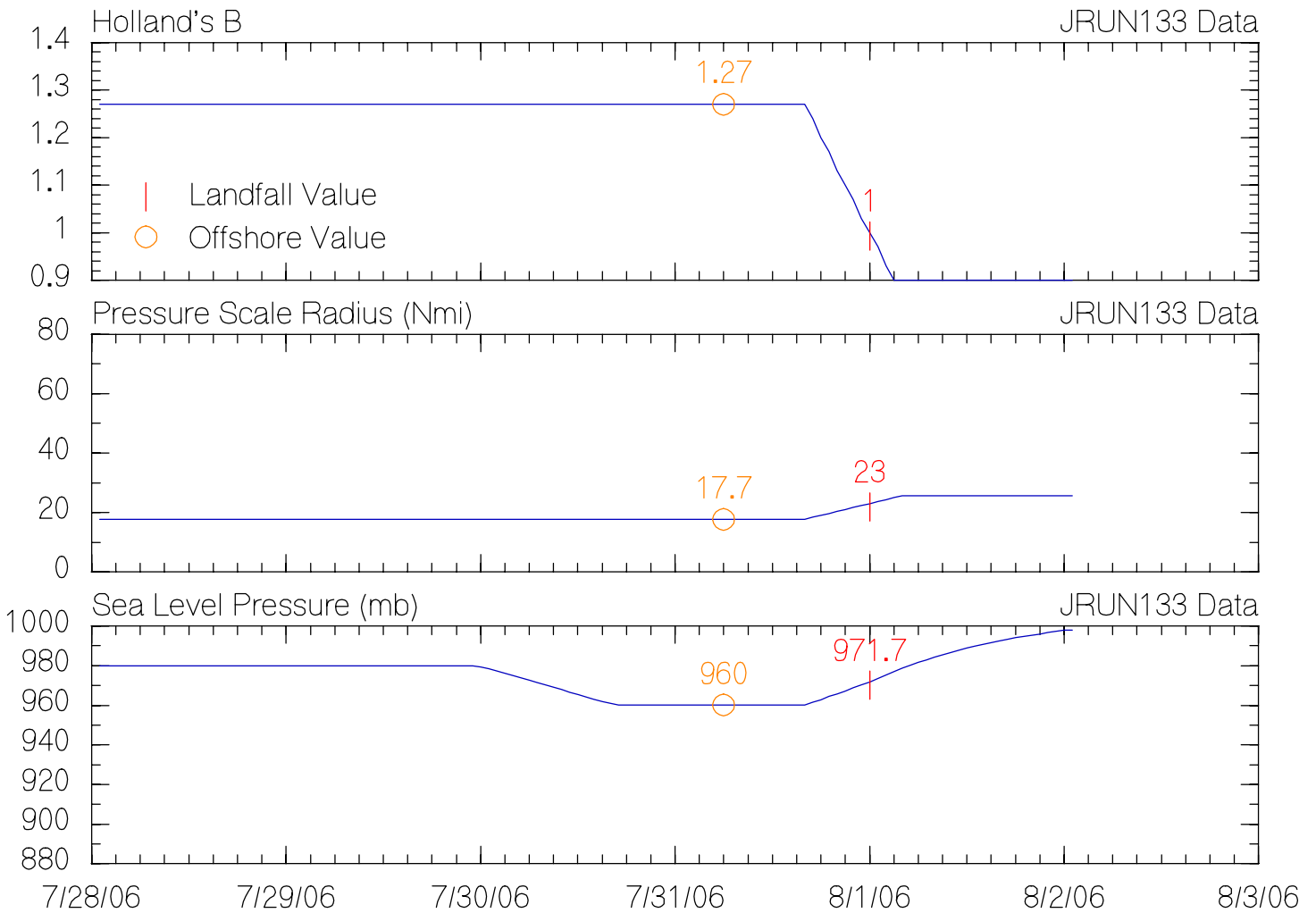
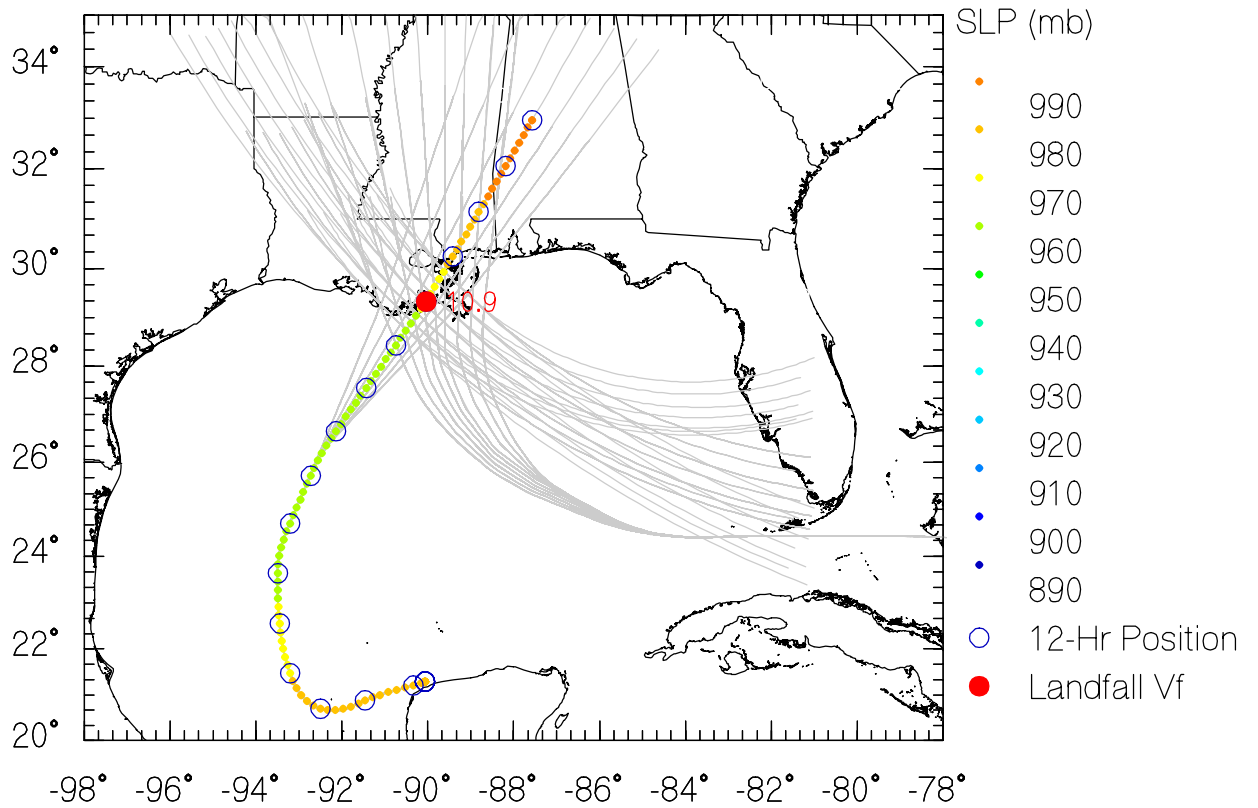

JRUN134 Data

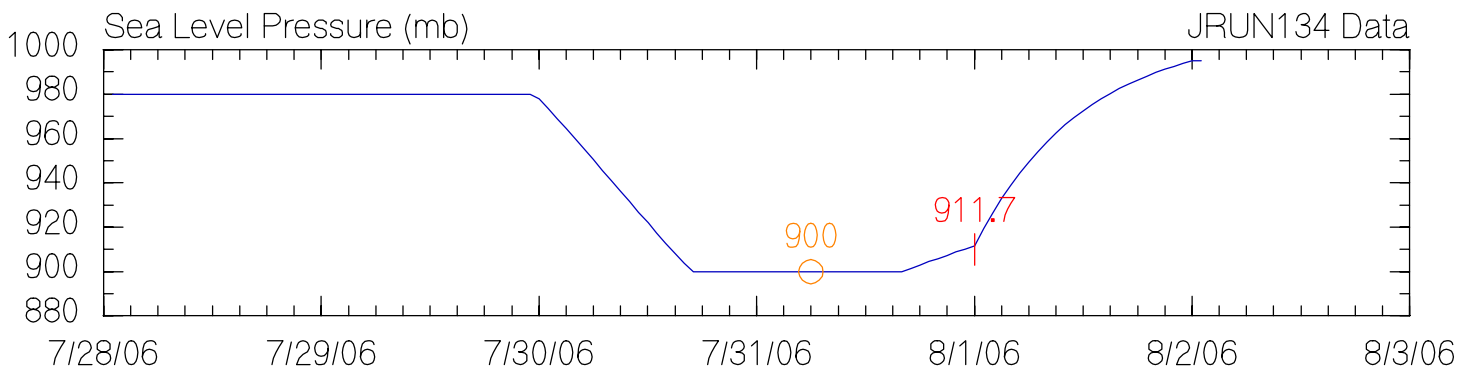
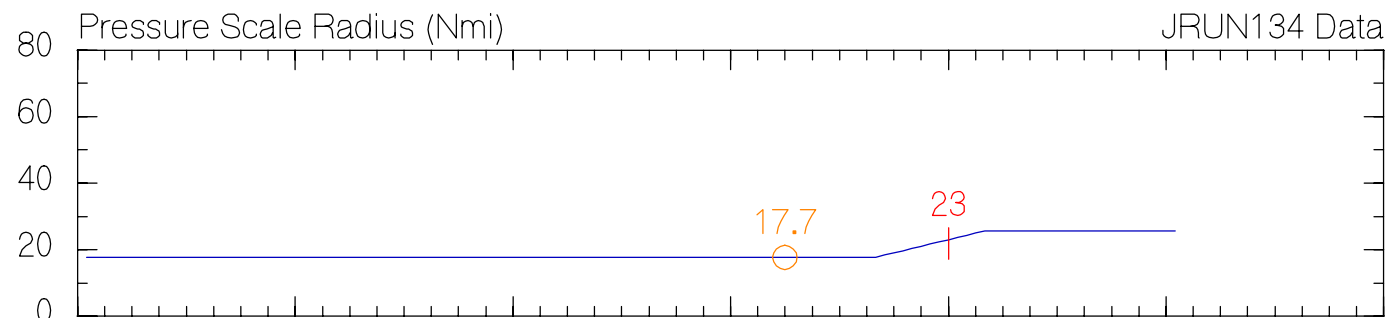
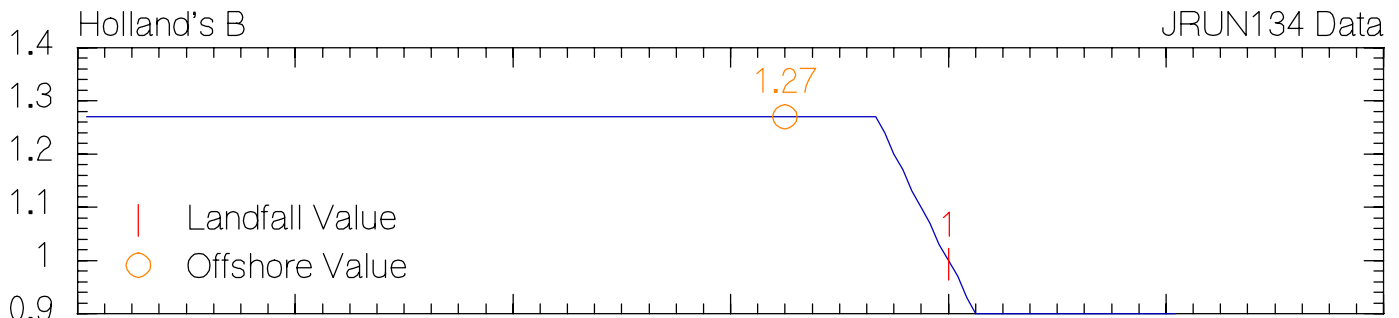
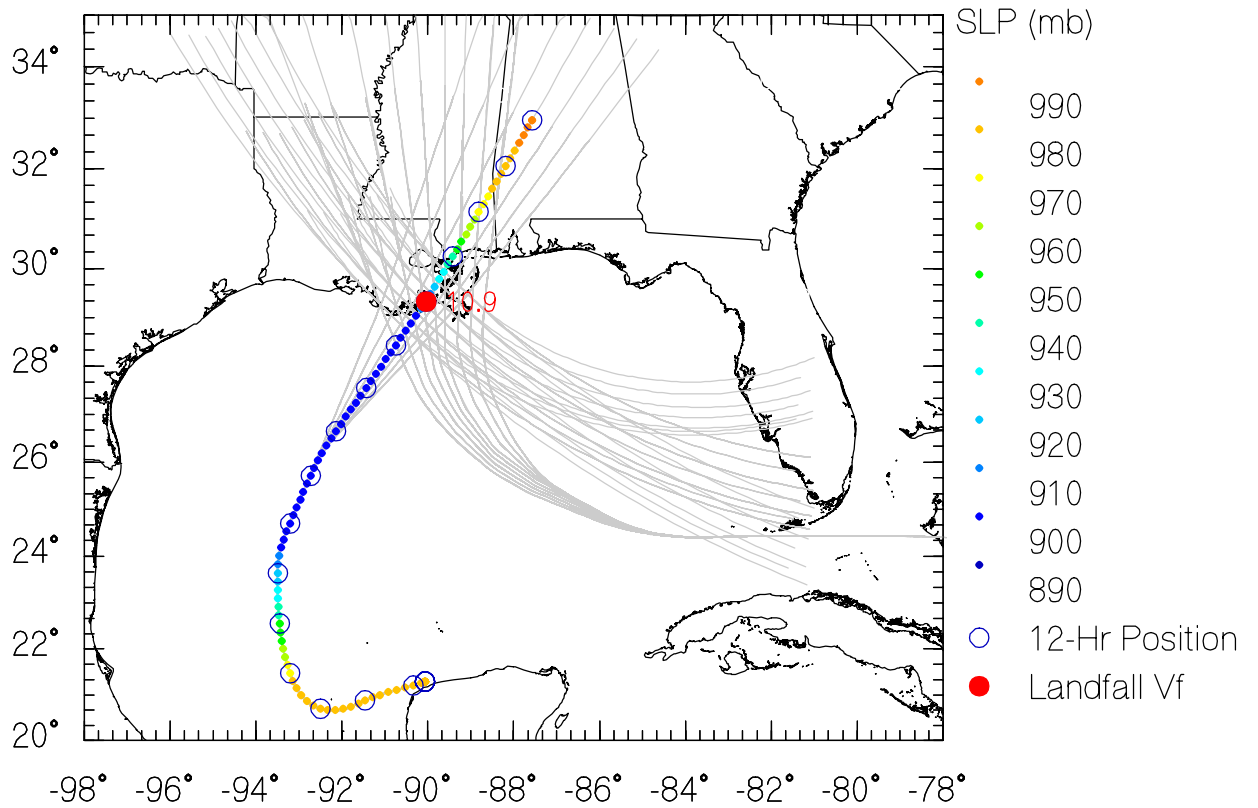

JRUN135 Data

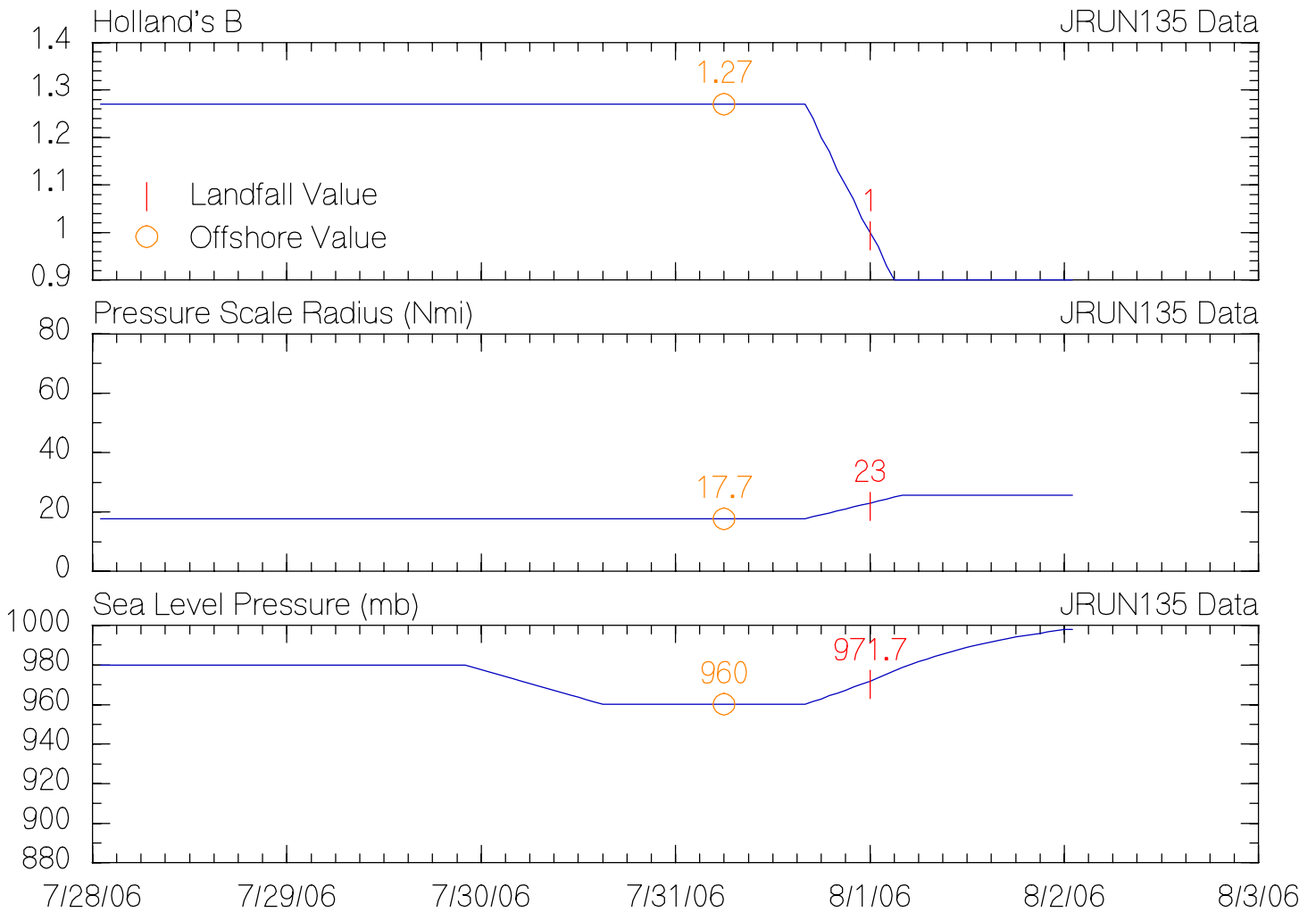
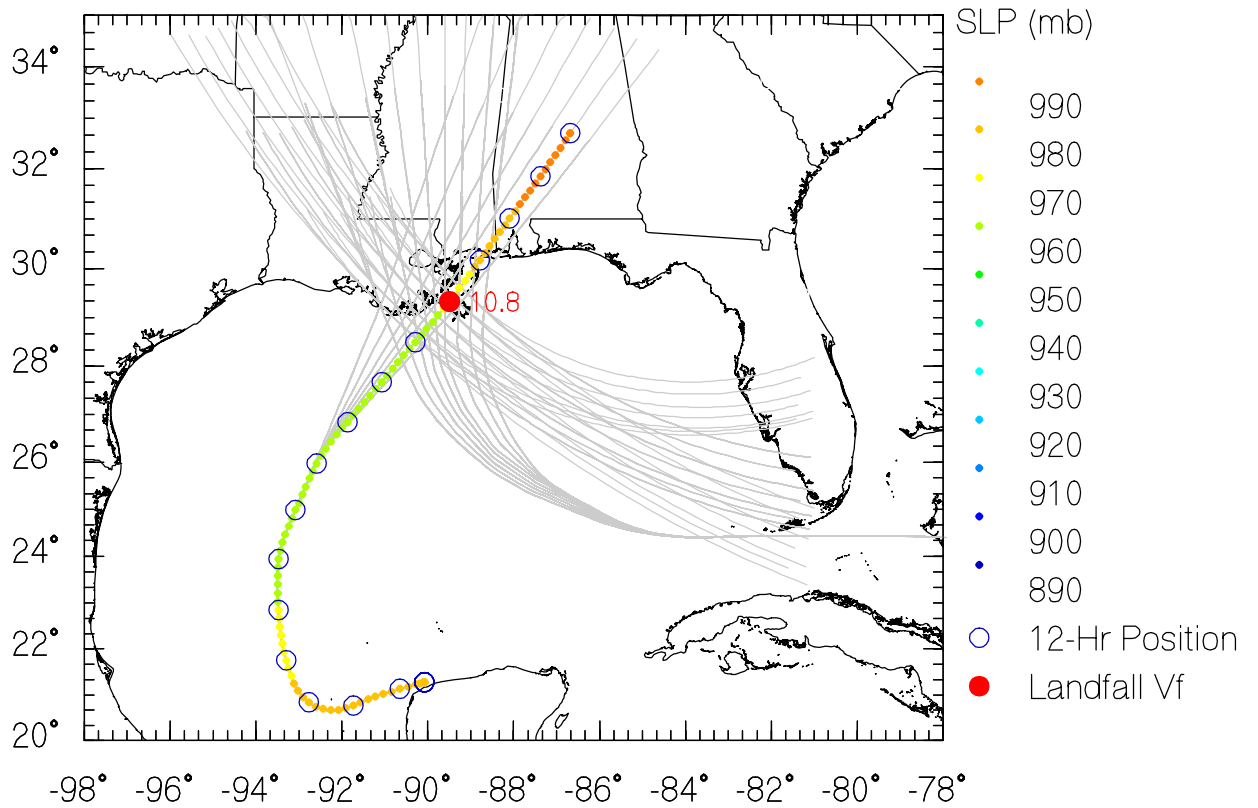

JRUN136 Data

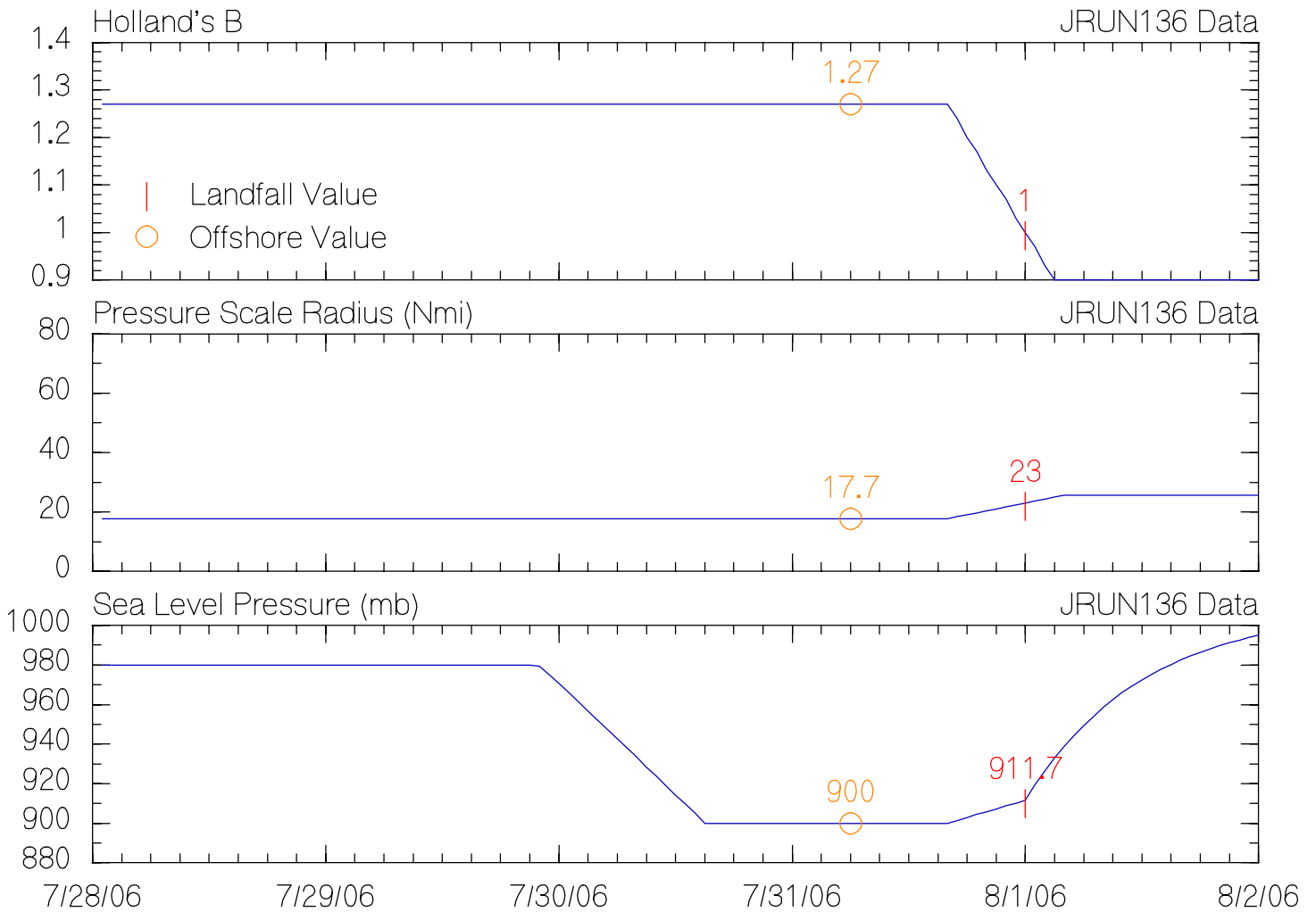
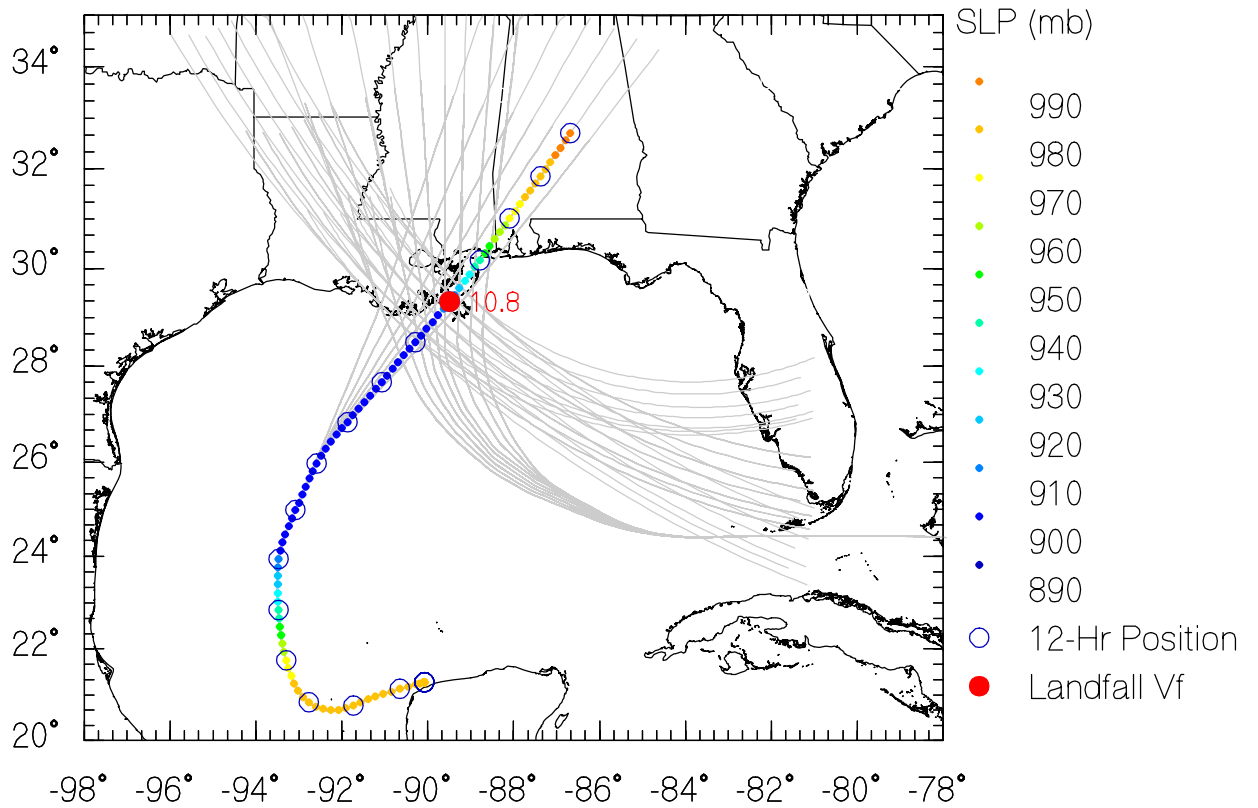

JRUN137 Data

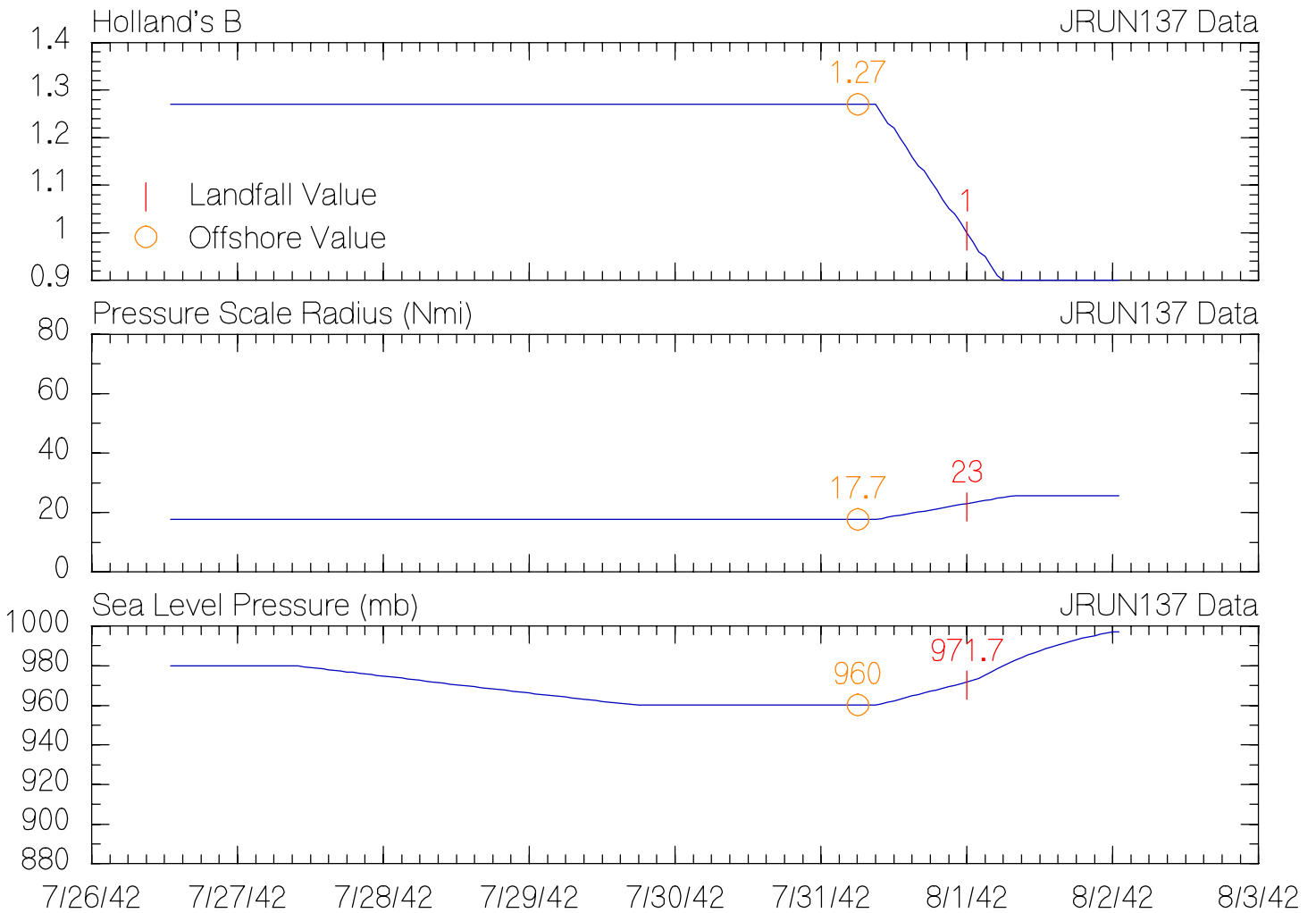
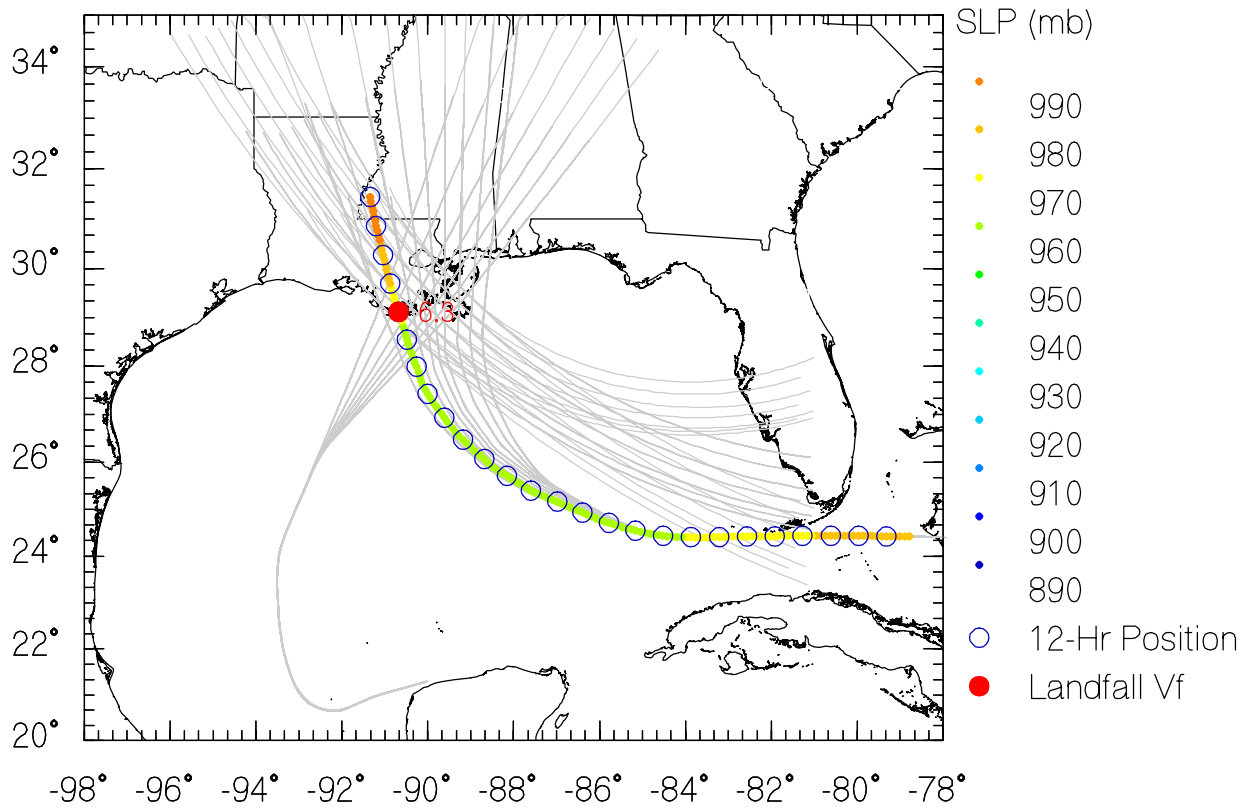

JRUN138 Data

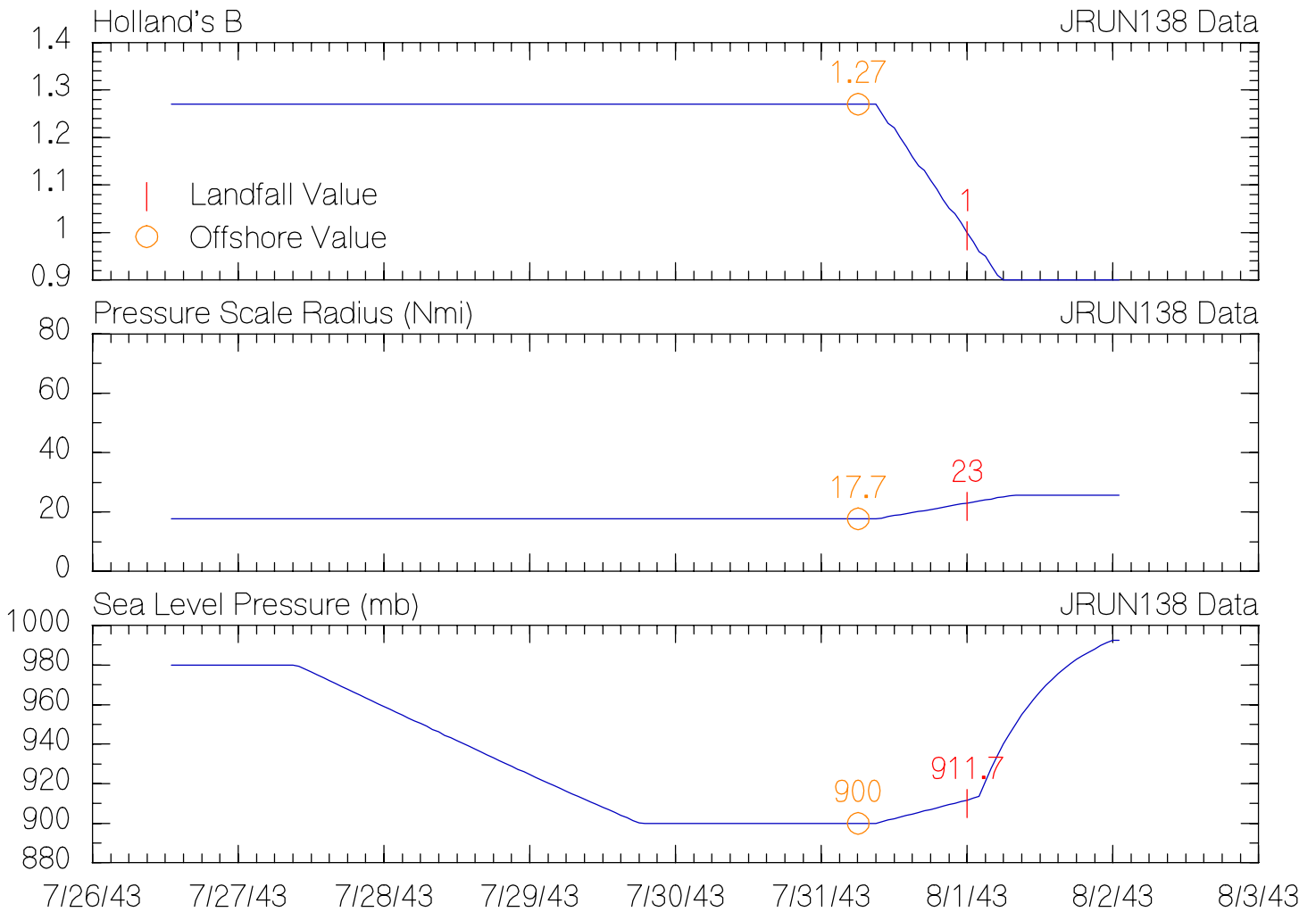
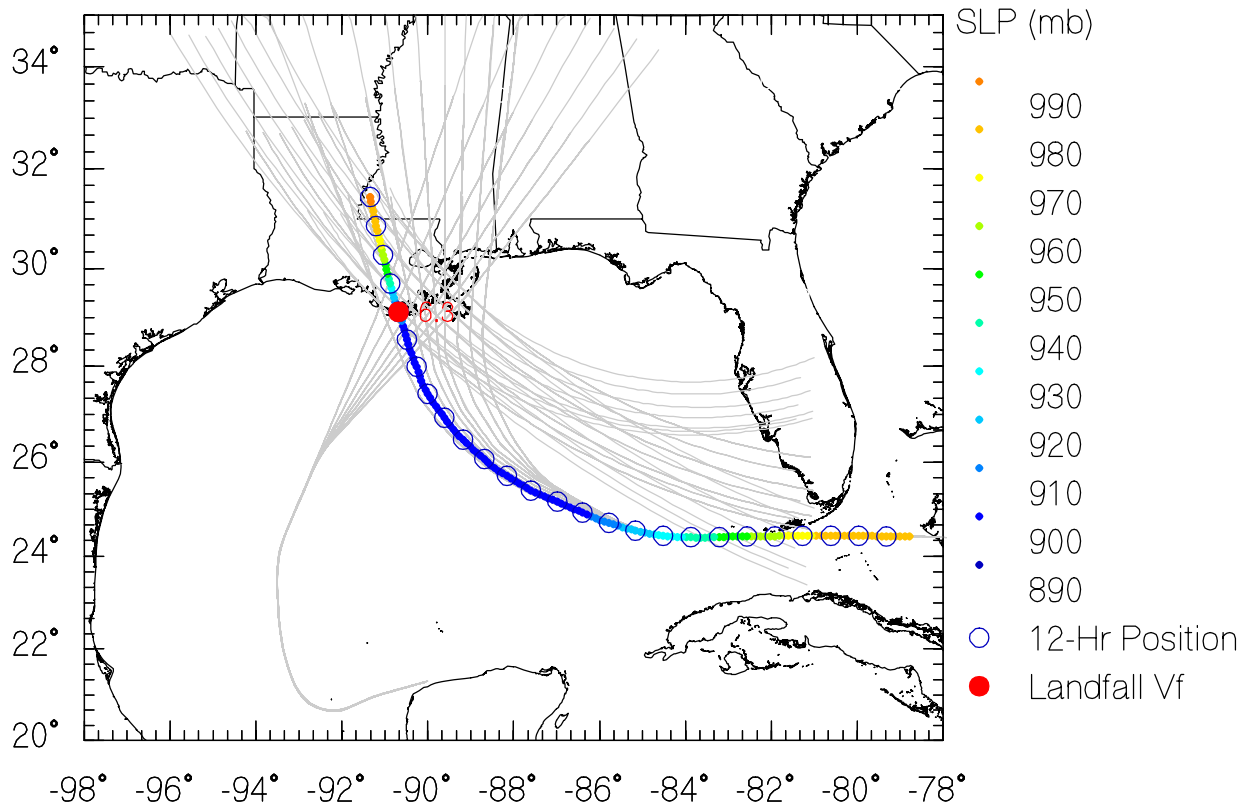

JRUN139 Data

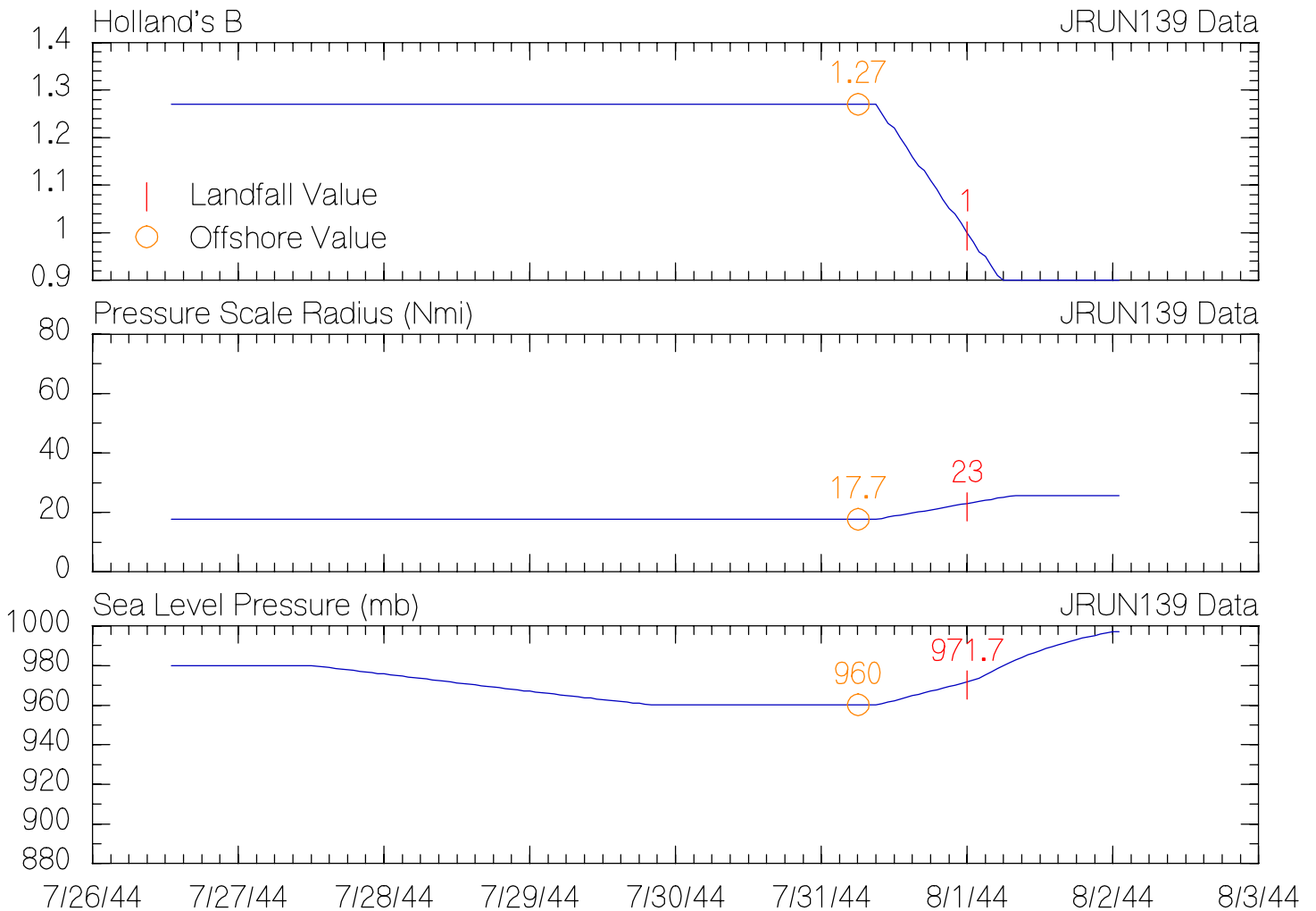
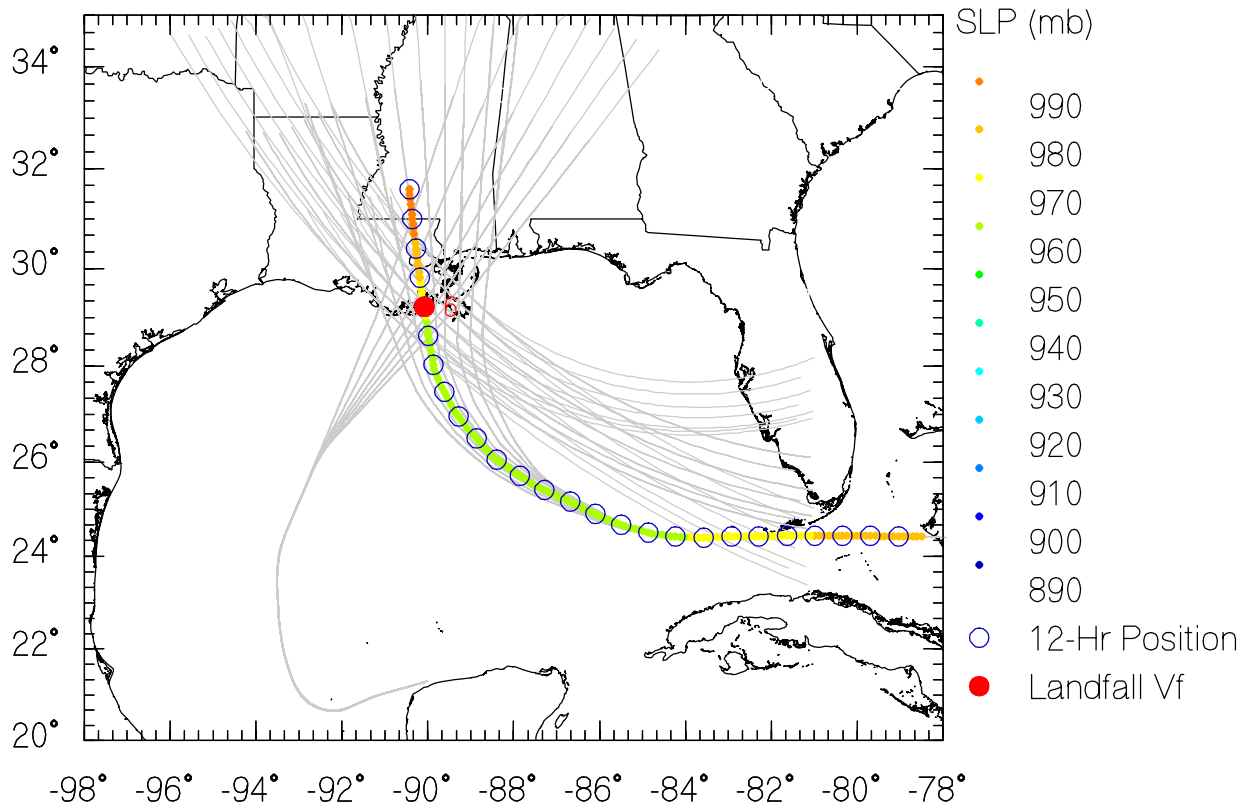

JRUN140 Data

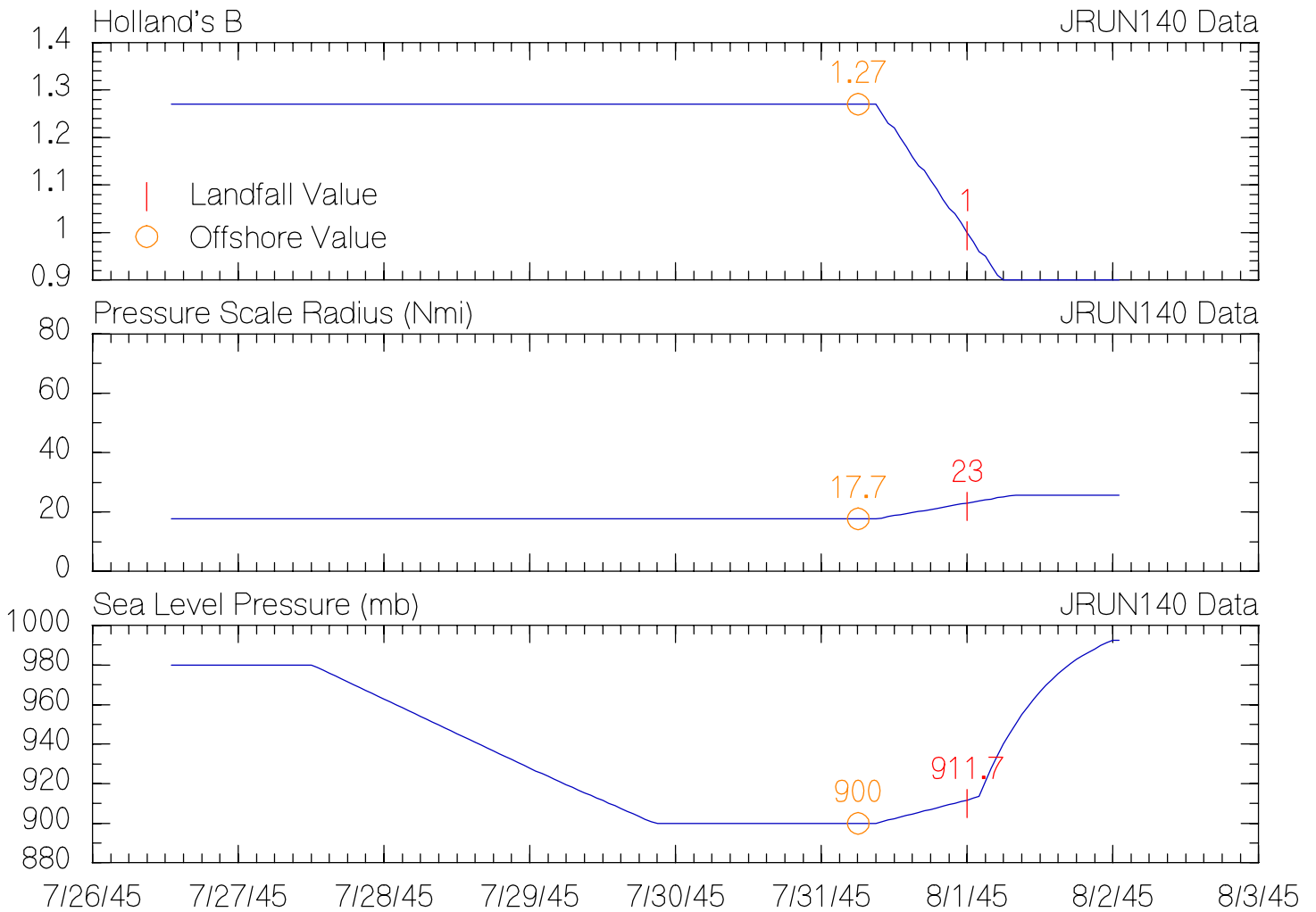
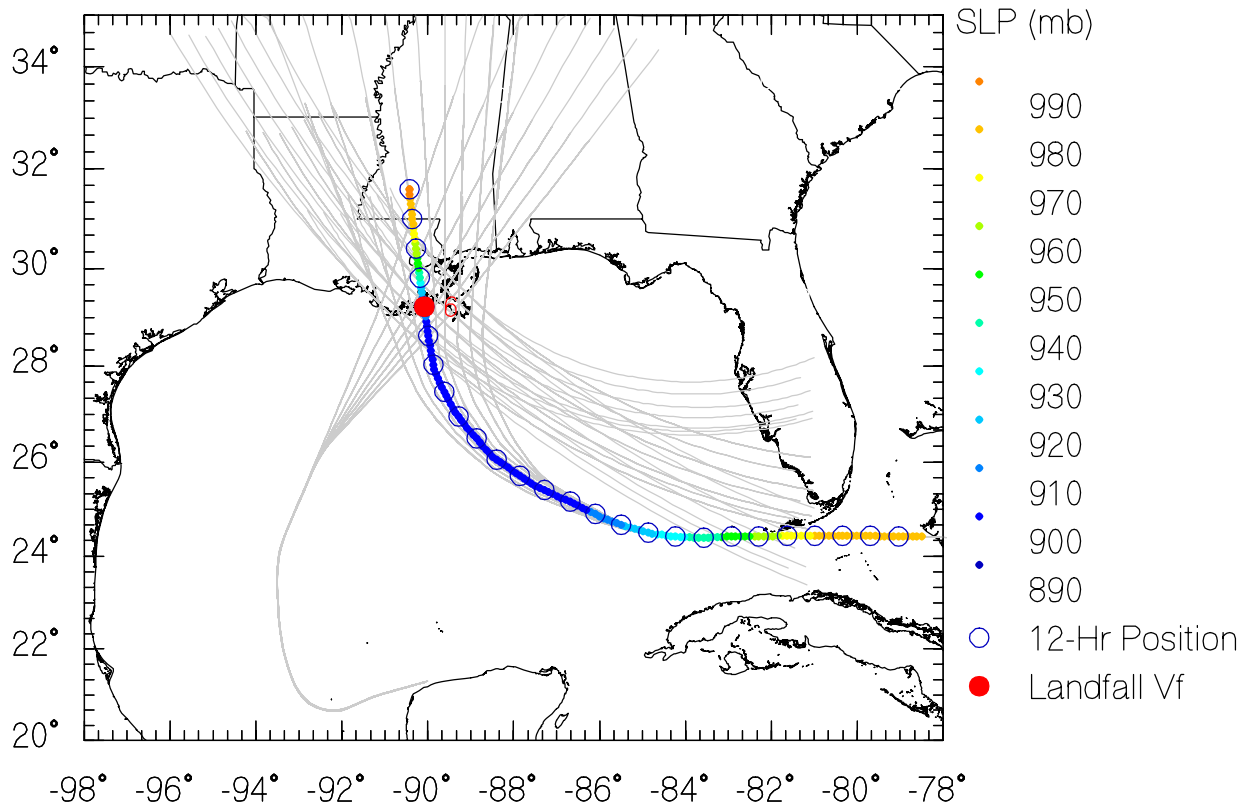

JRUN141 Data

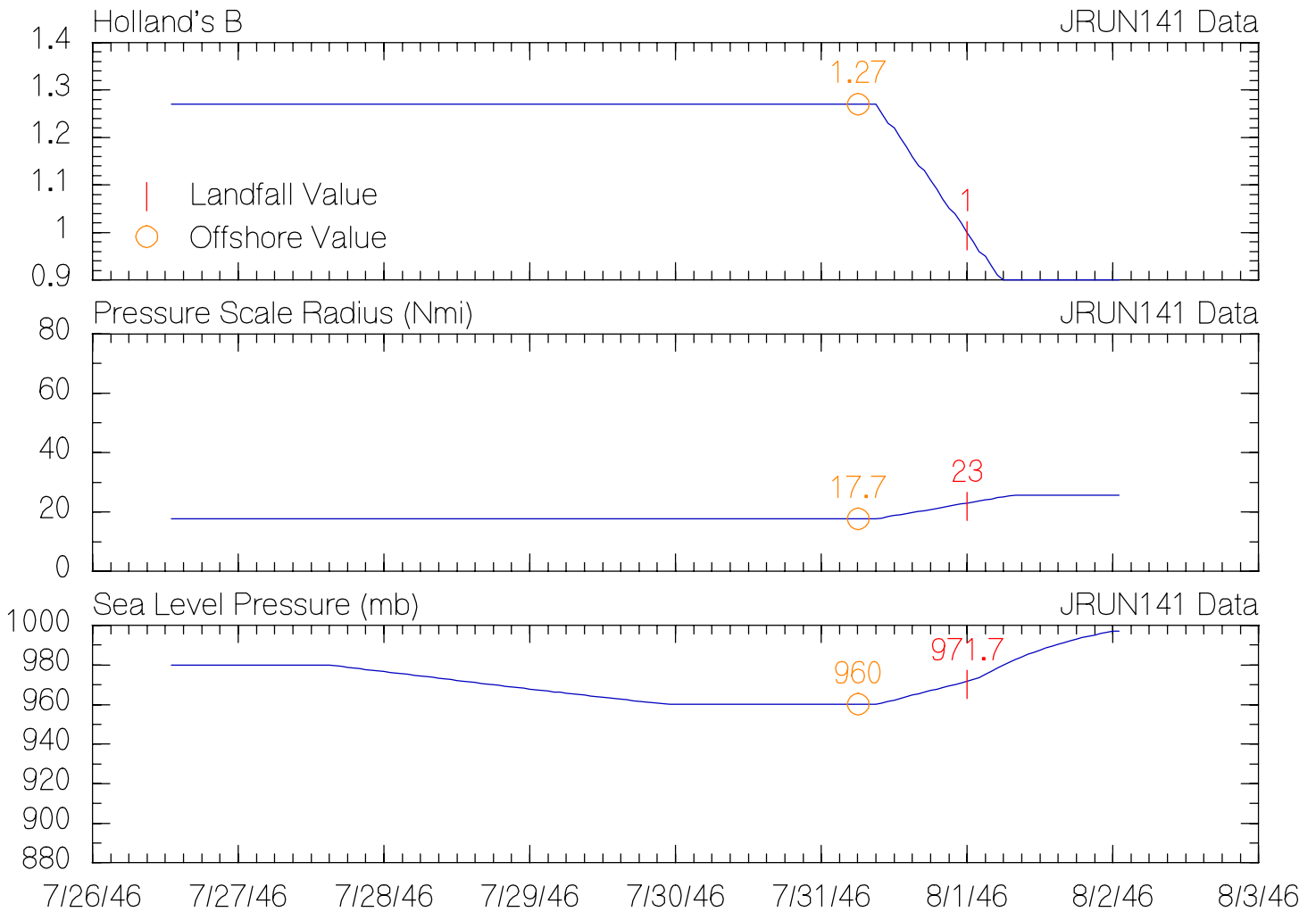
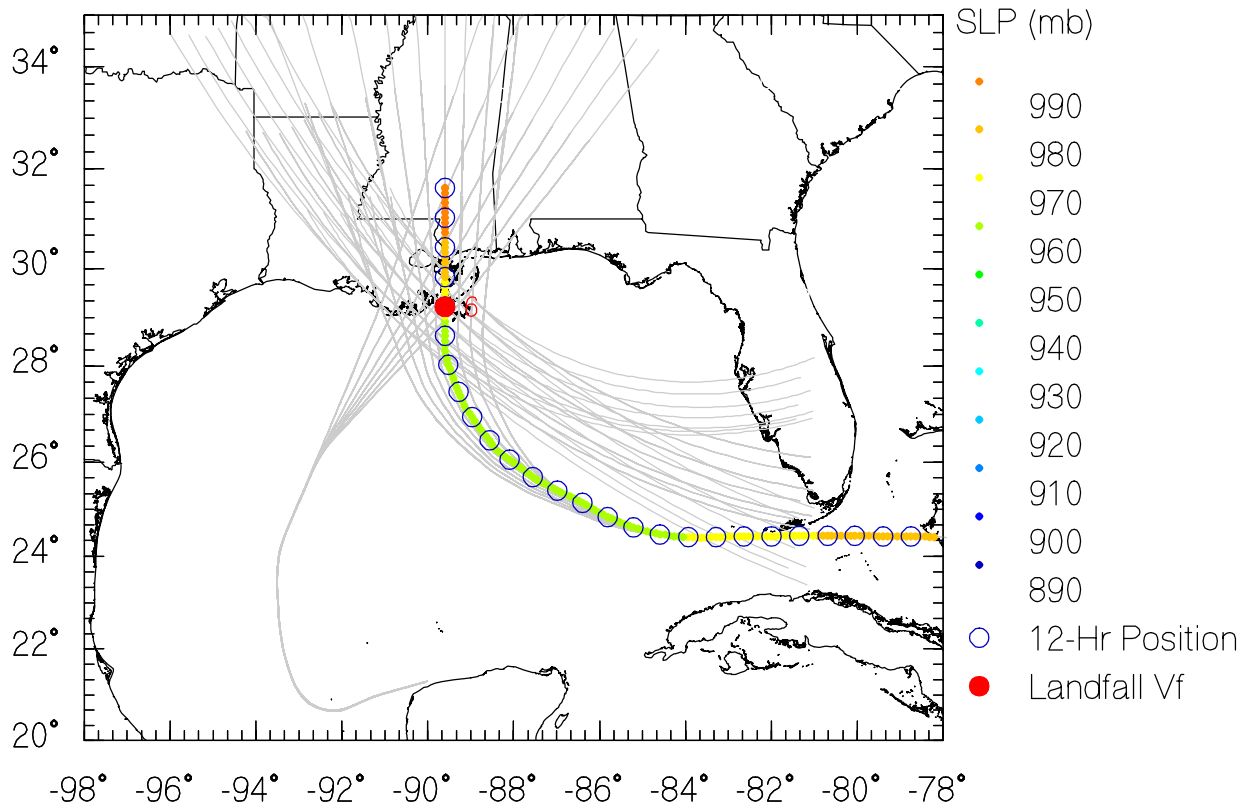

JRUN142 Data

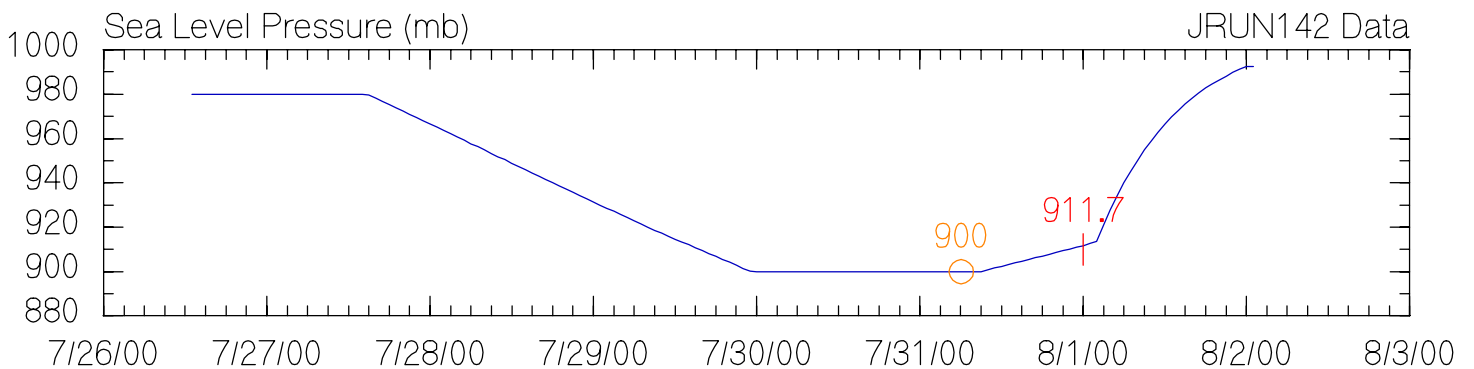
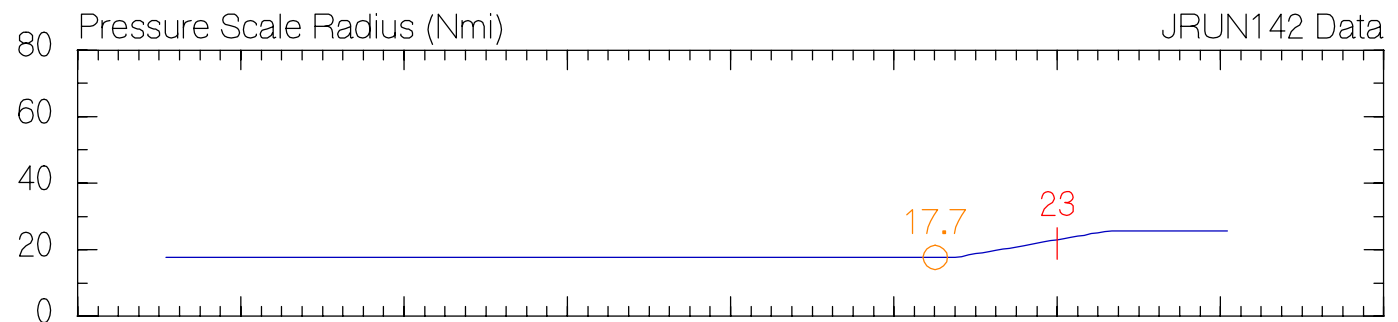
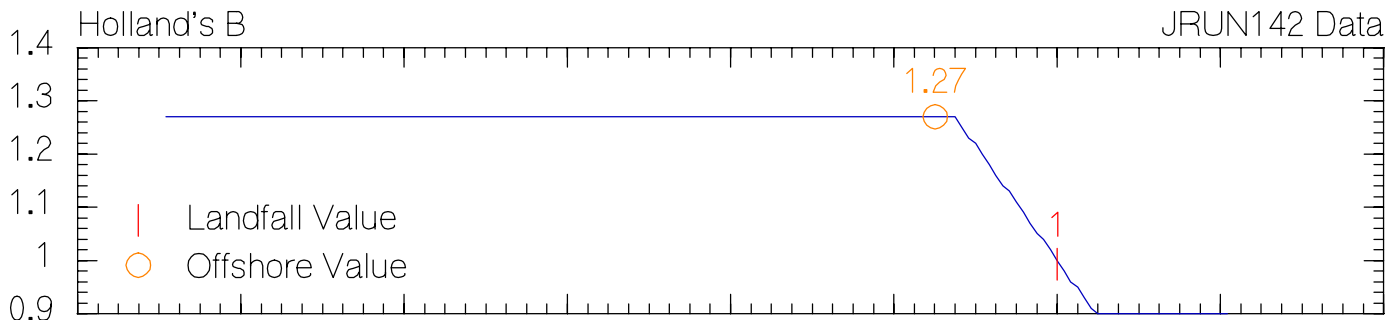
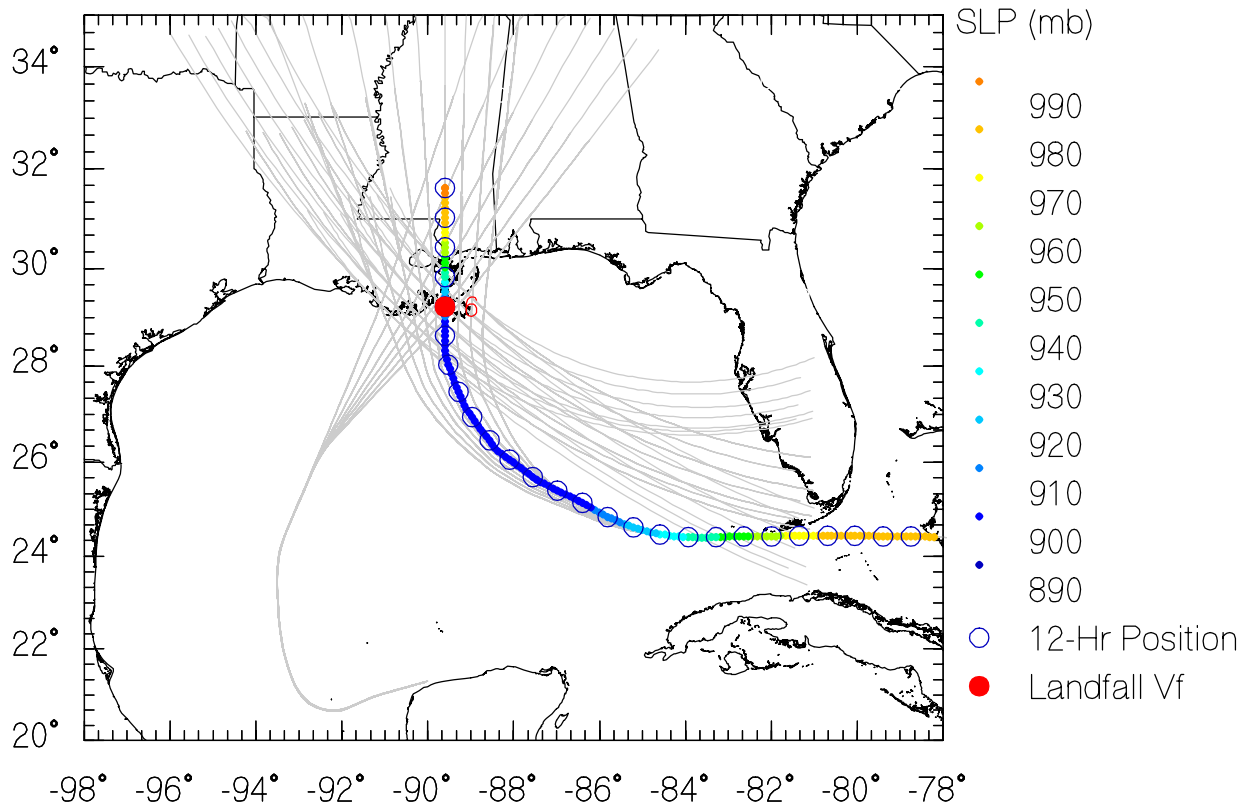

JRUN143 Data

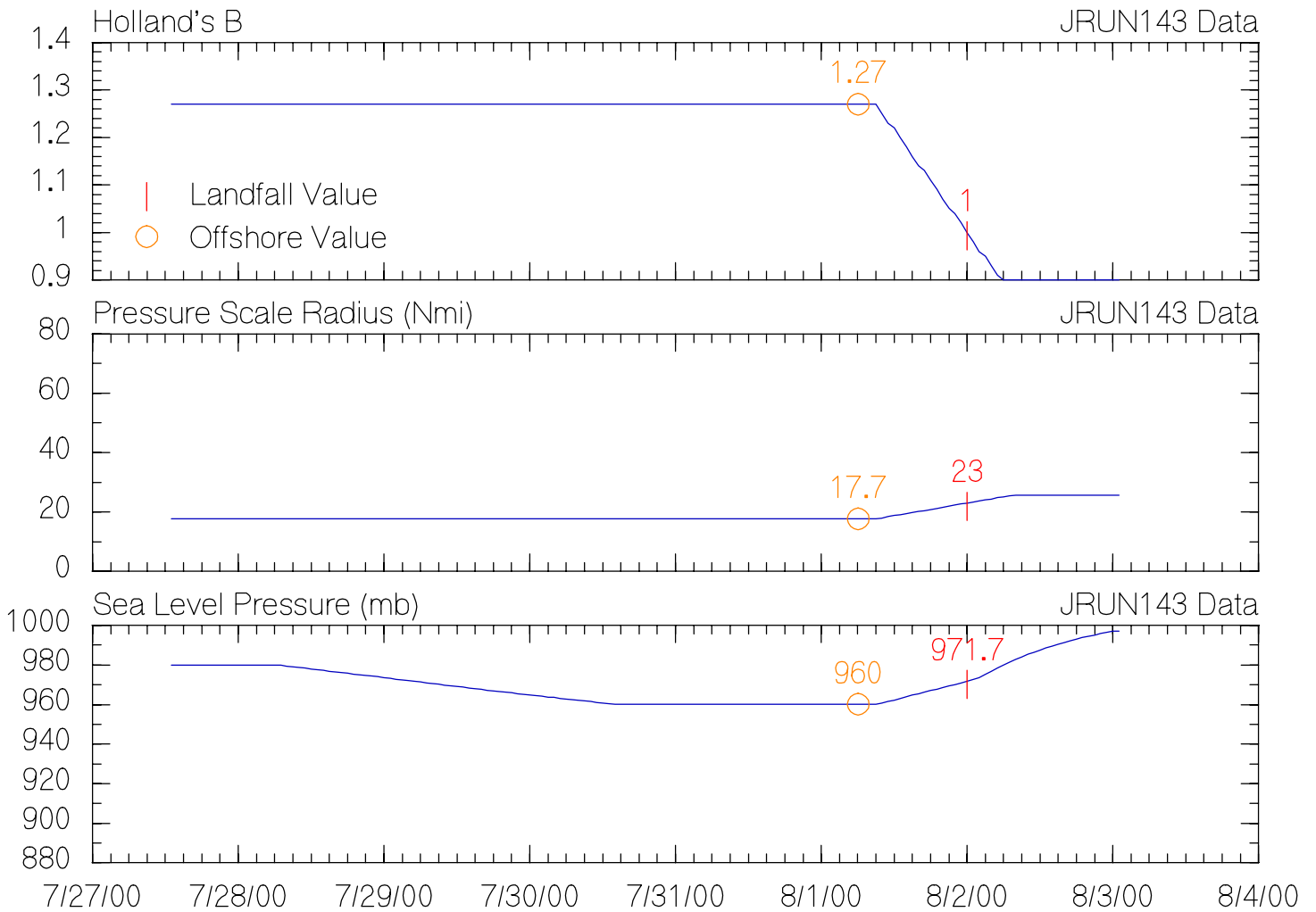
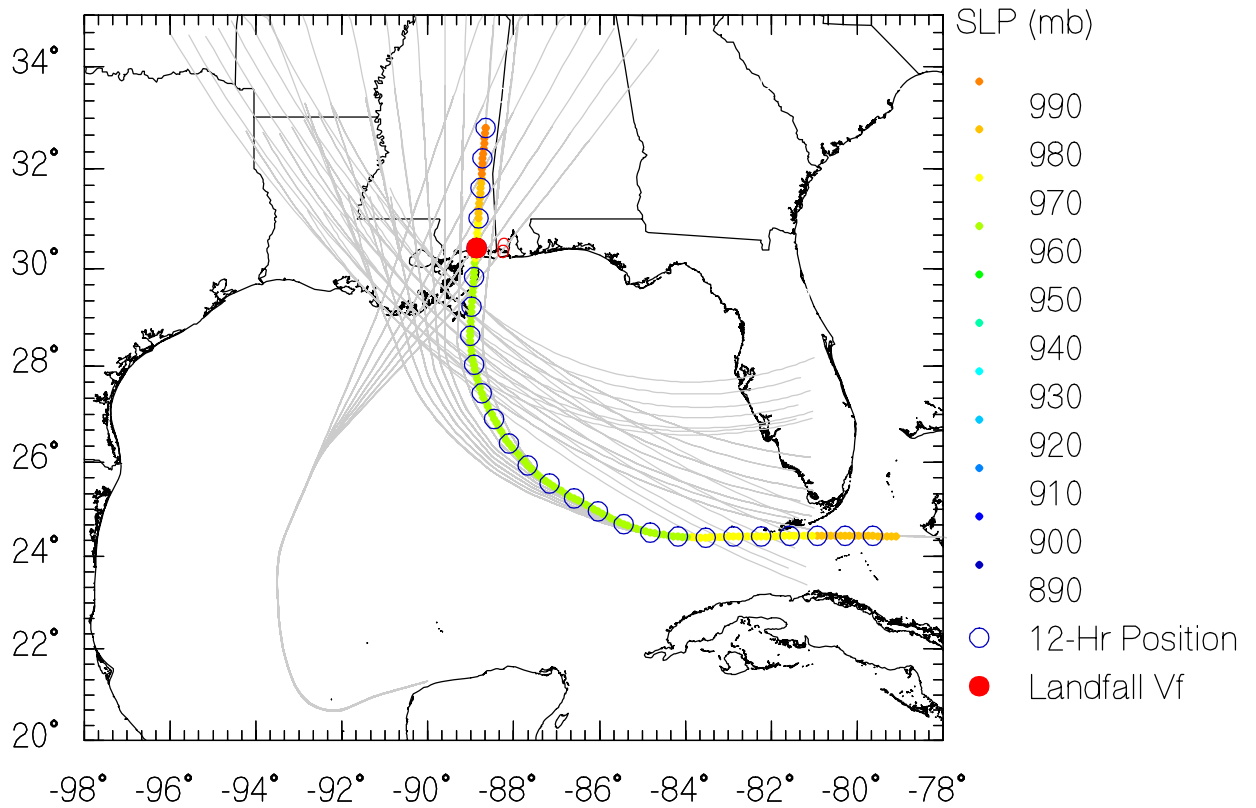

JRUN144 Data

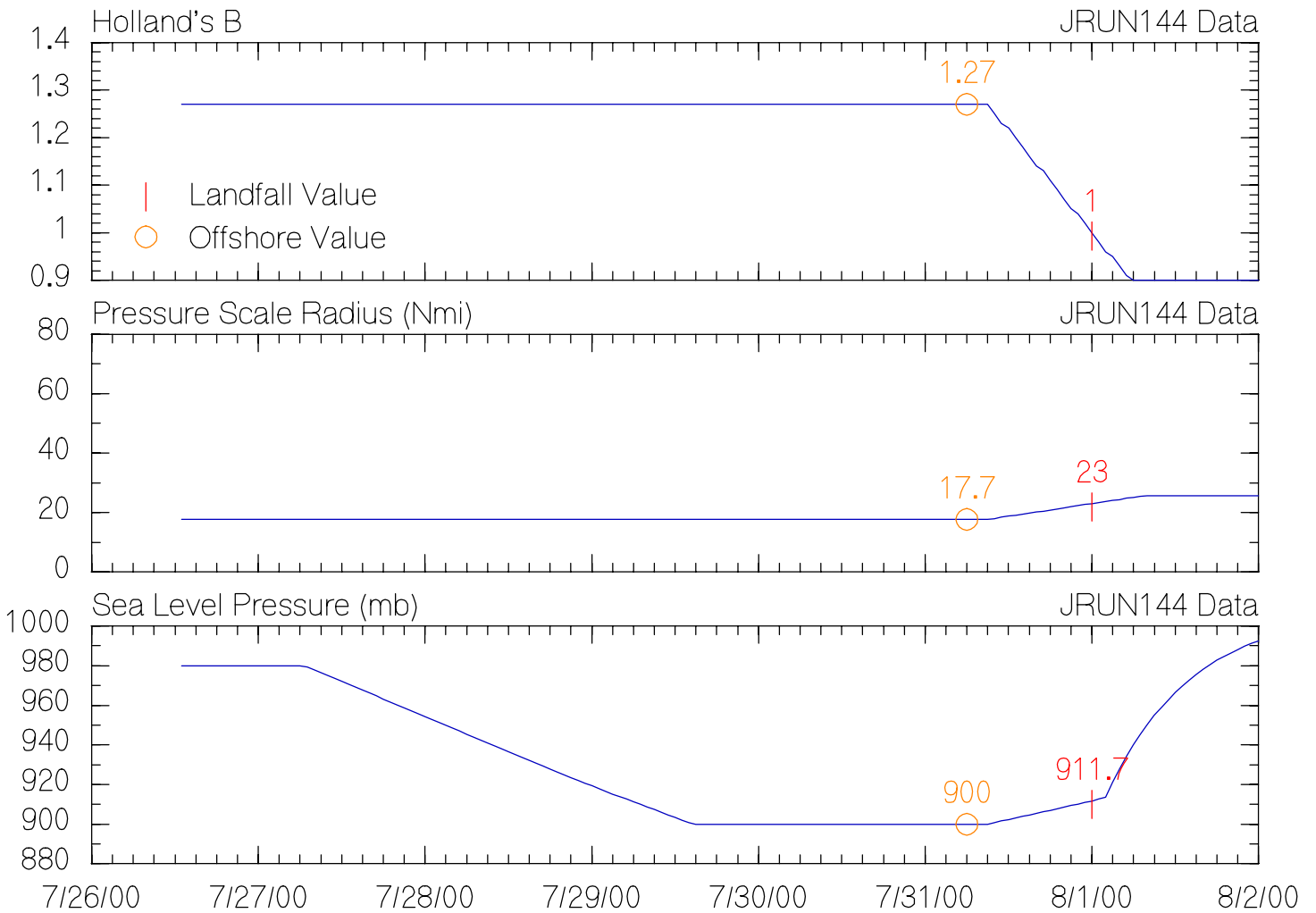
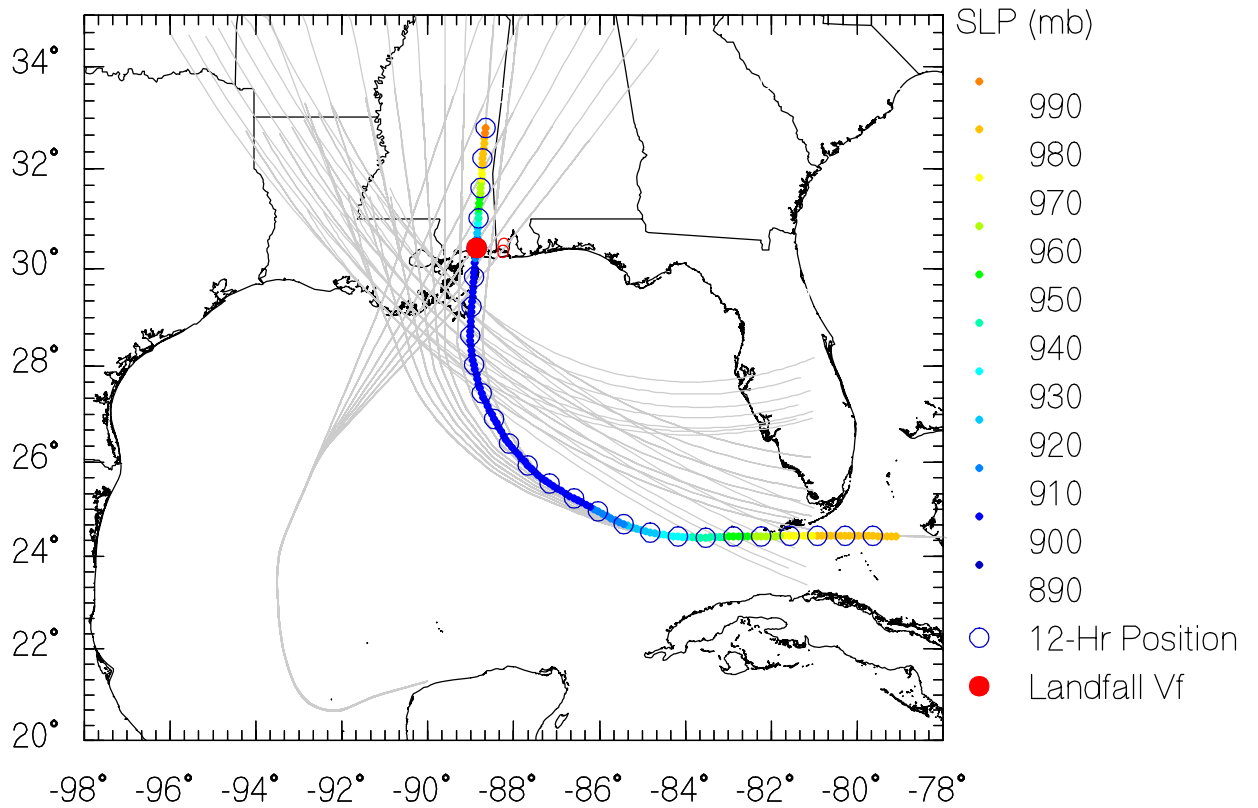

JRUN145 Data

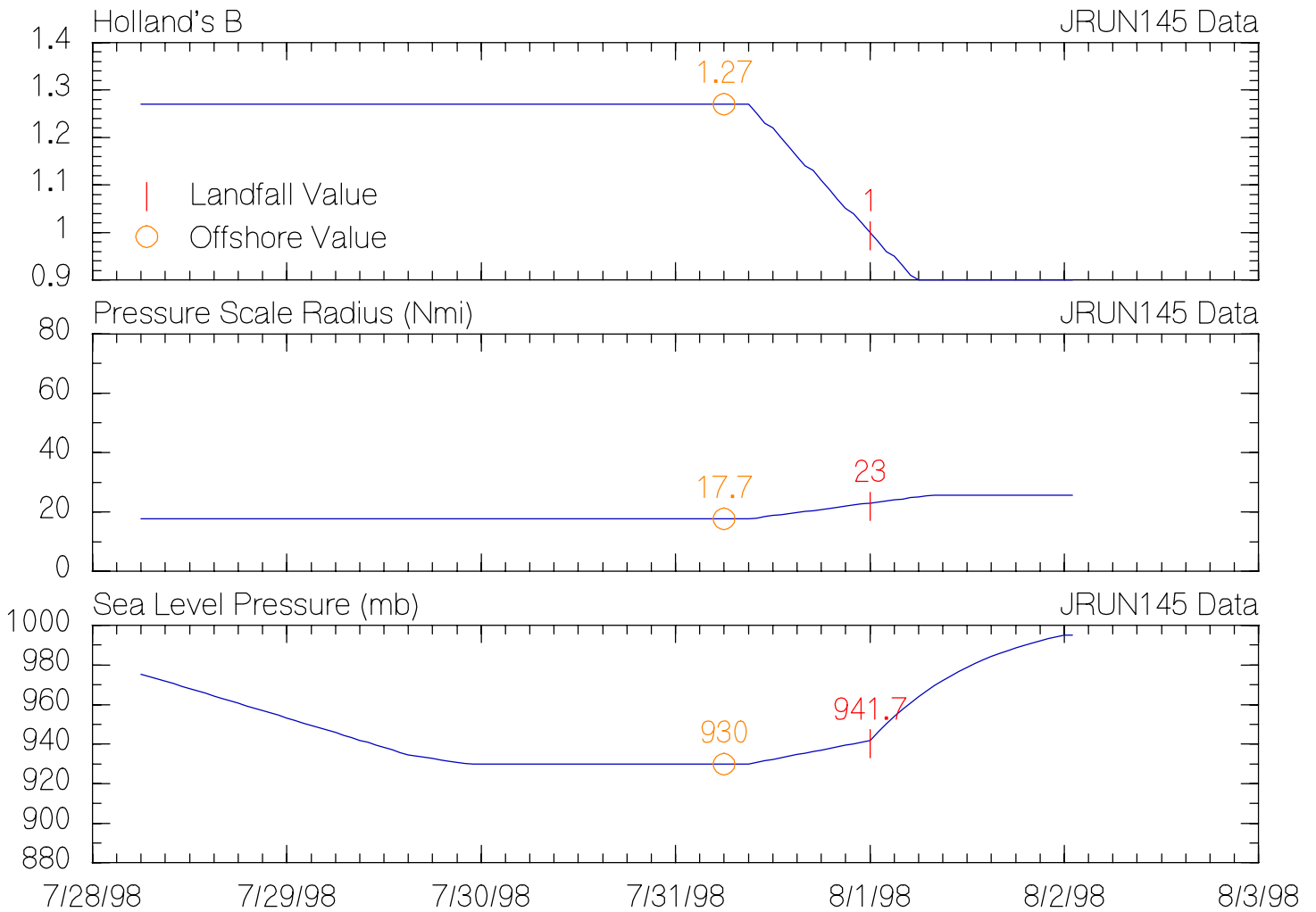
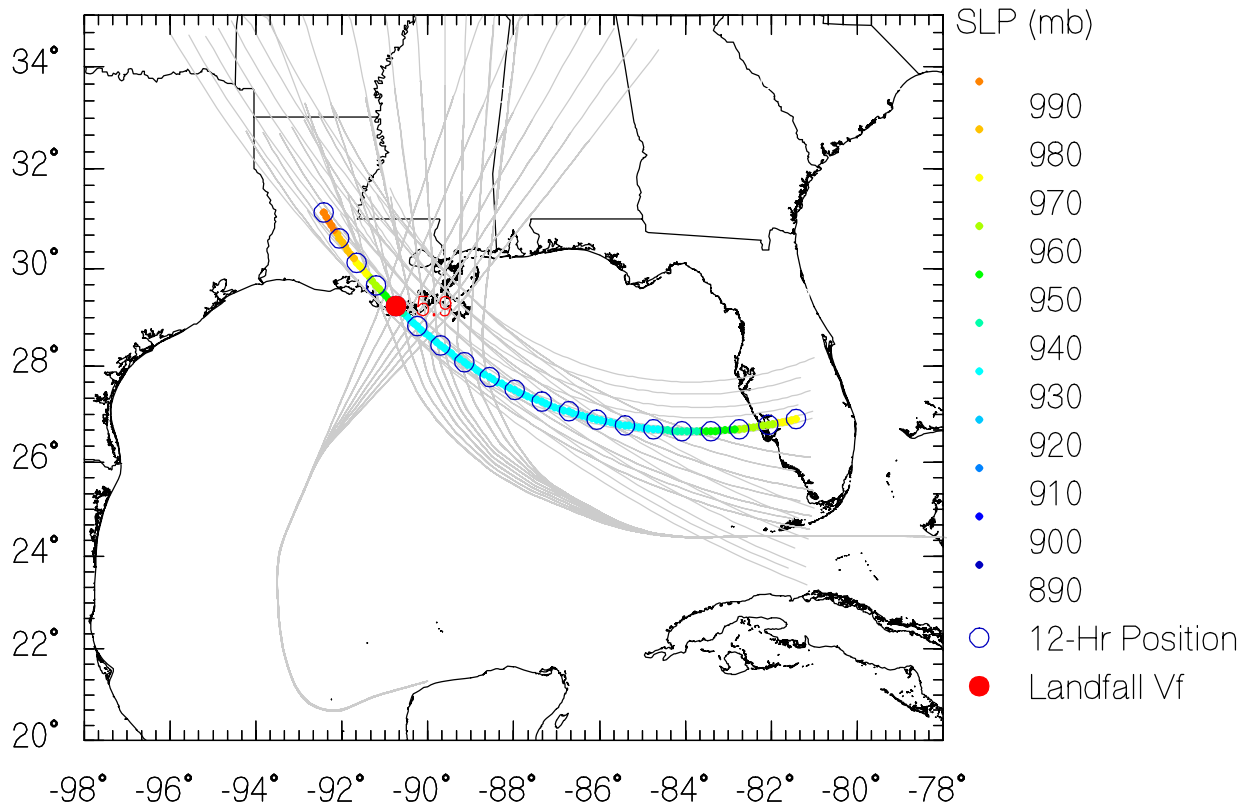

JRUN146 Data

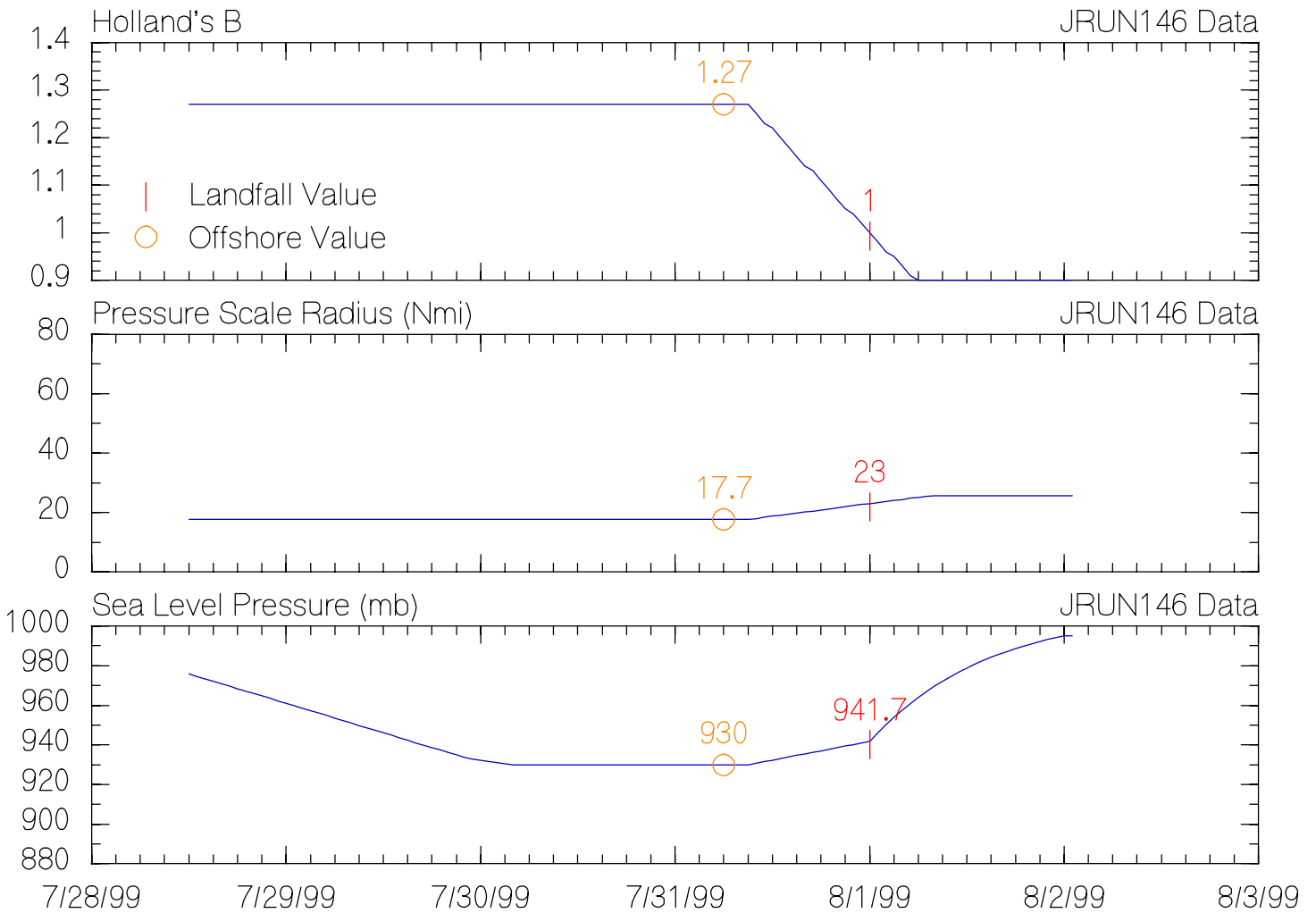
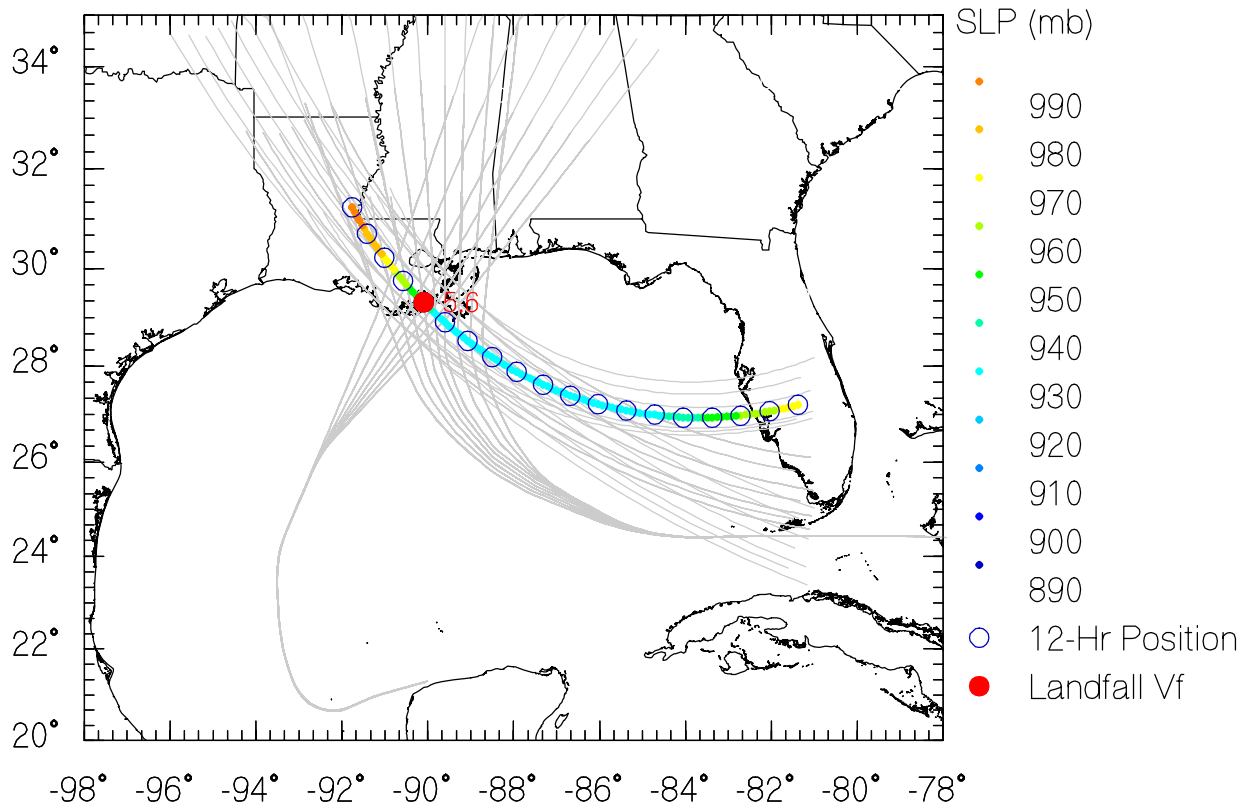

JRUN147 Data

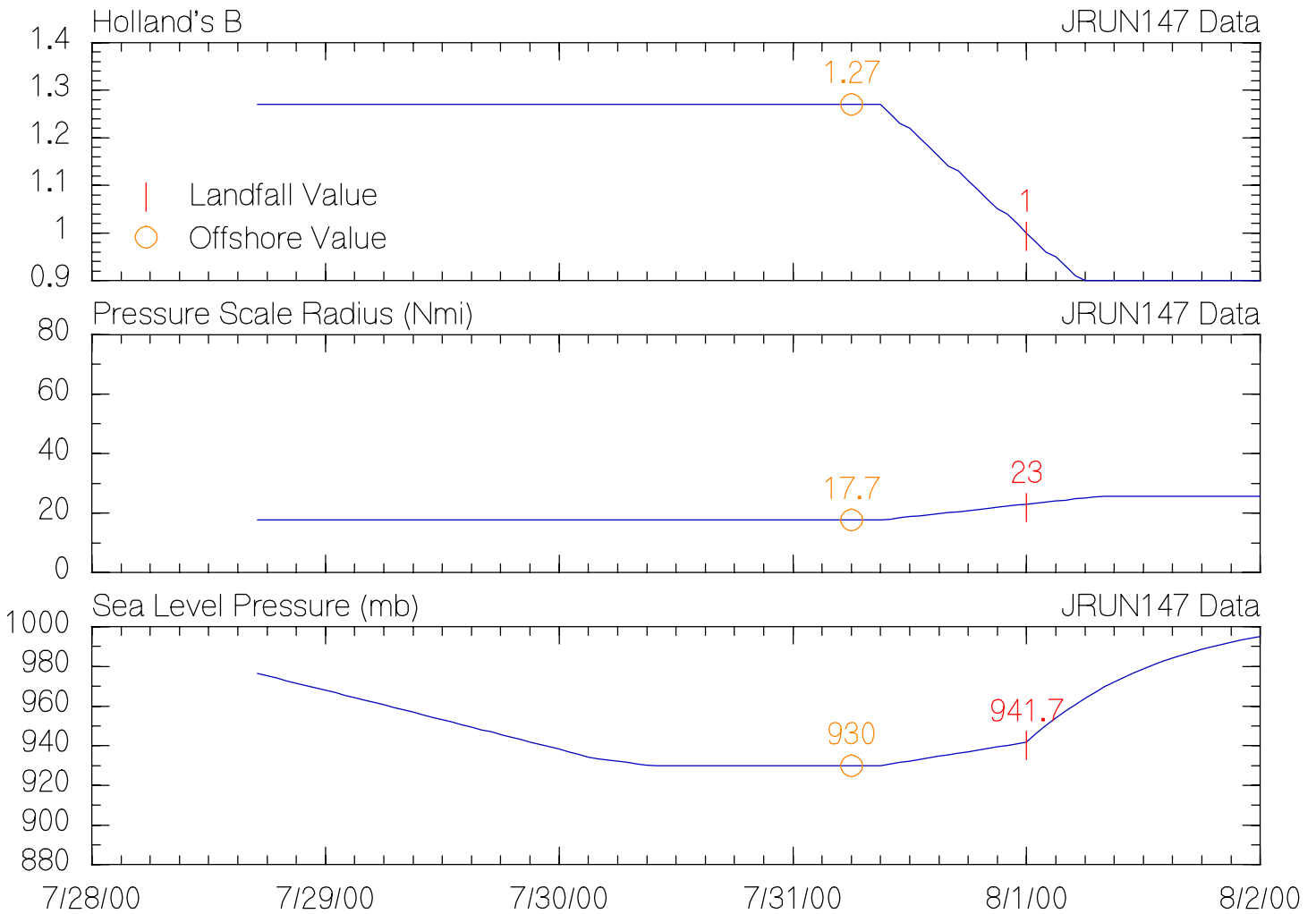
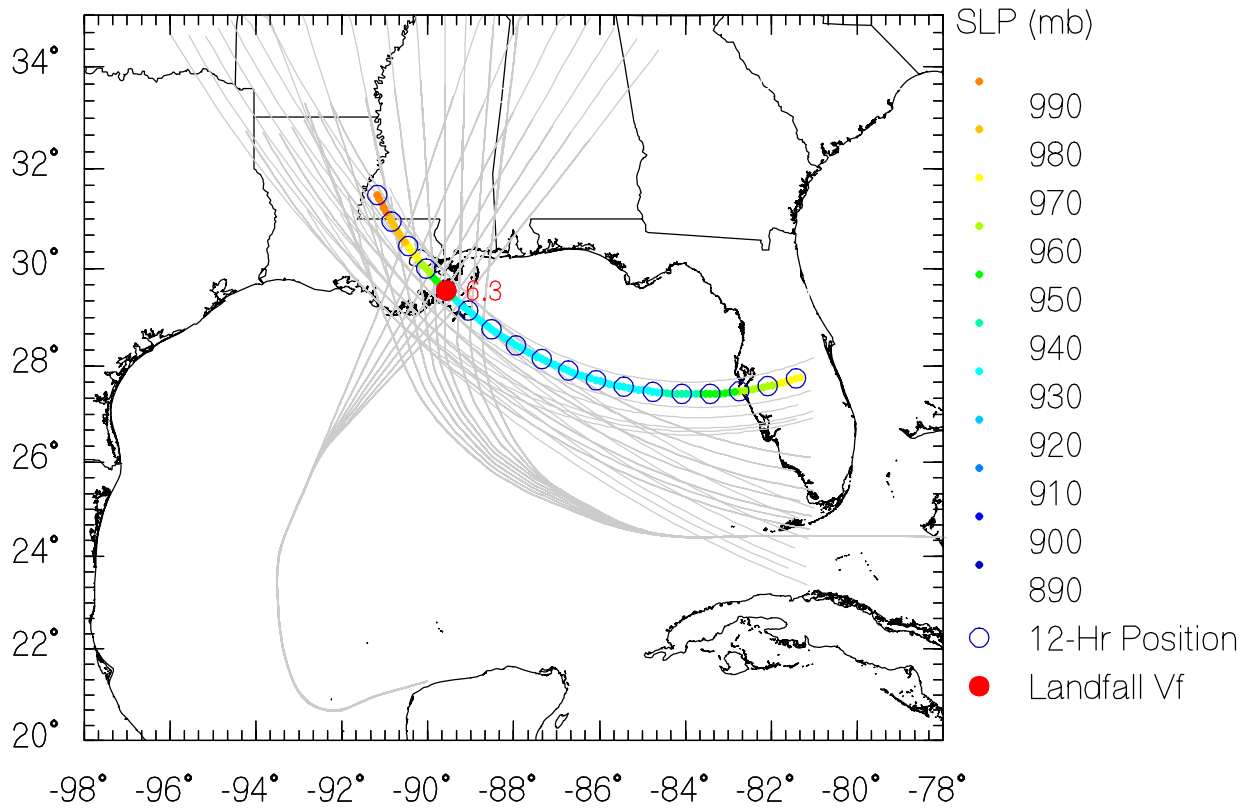

JRUN149 Data

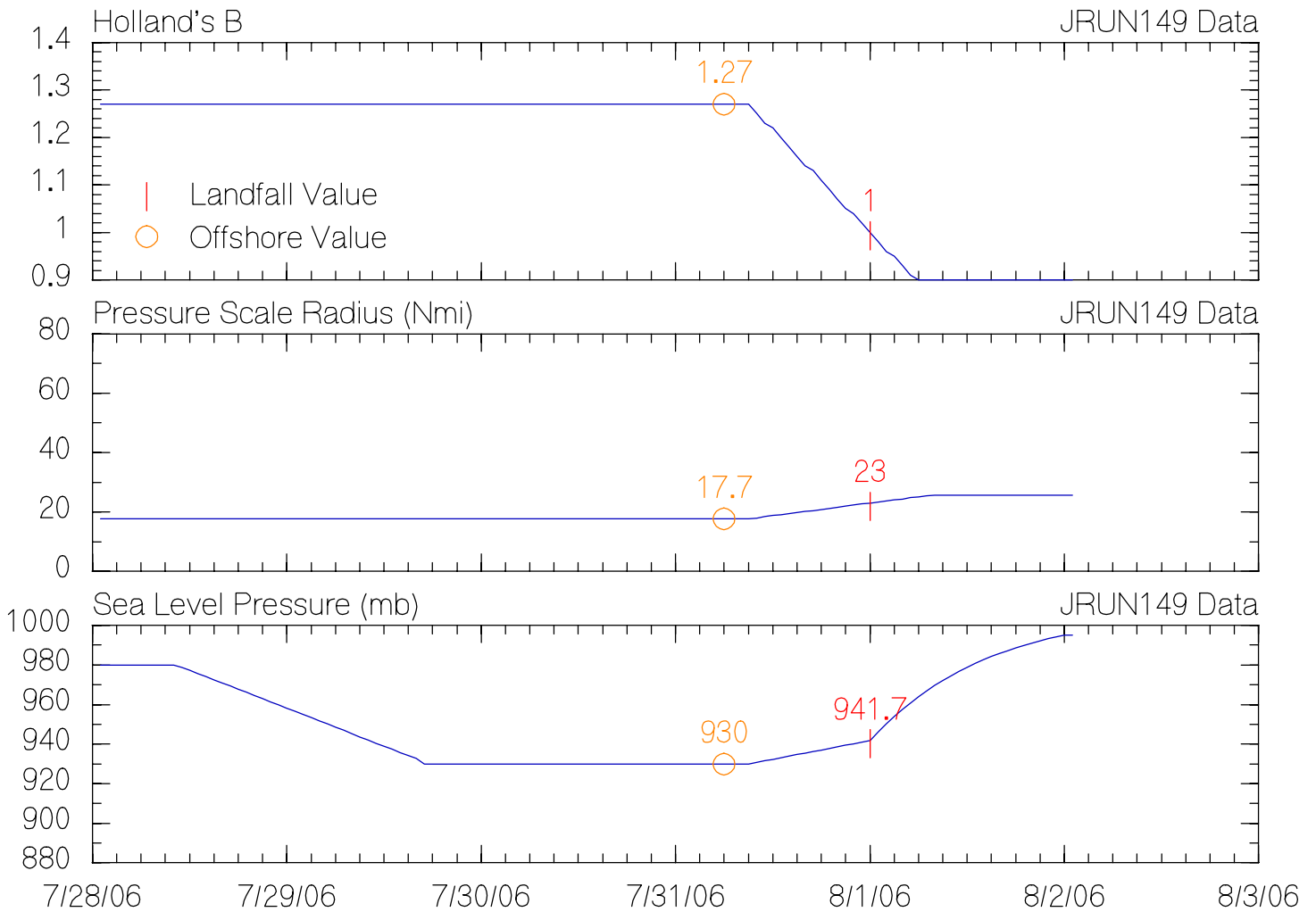
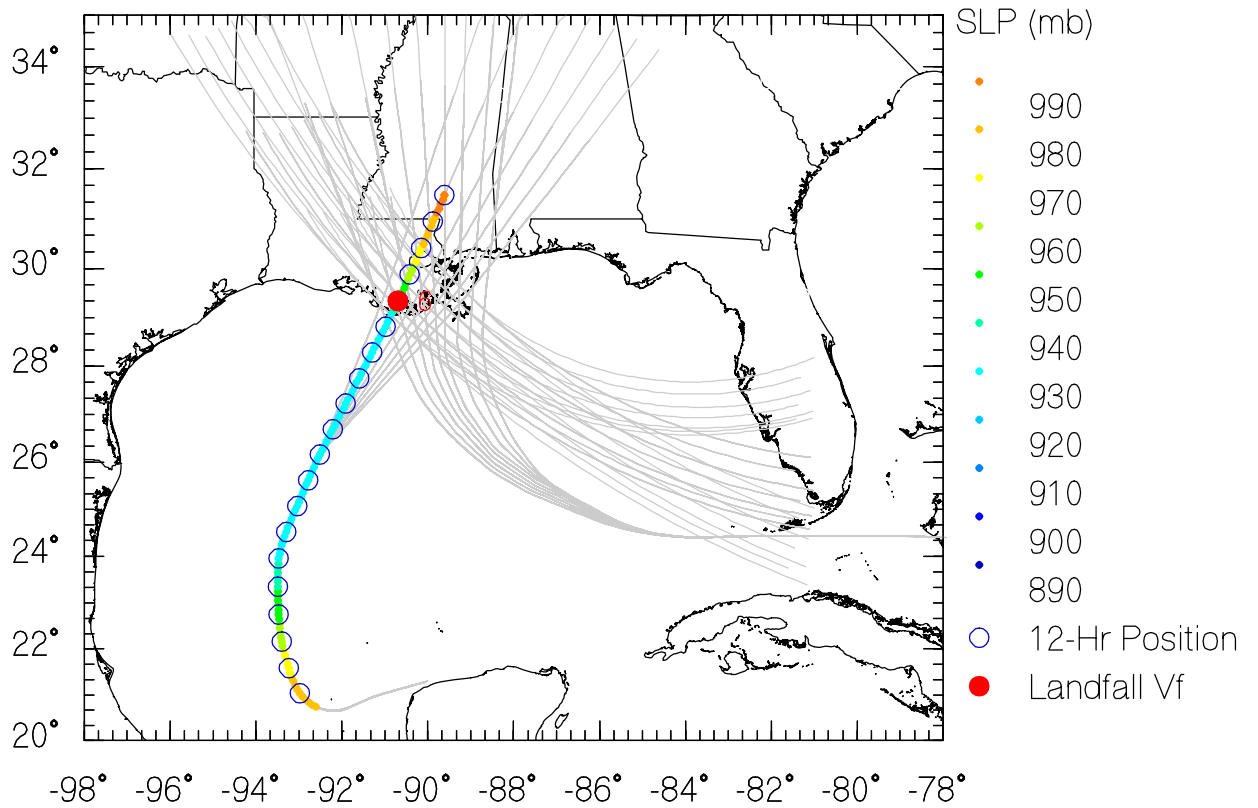

JRUN150 Data

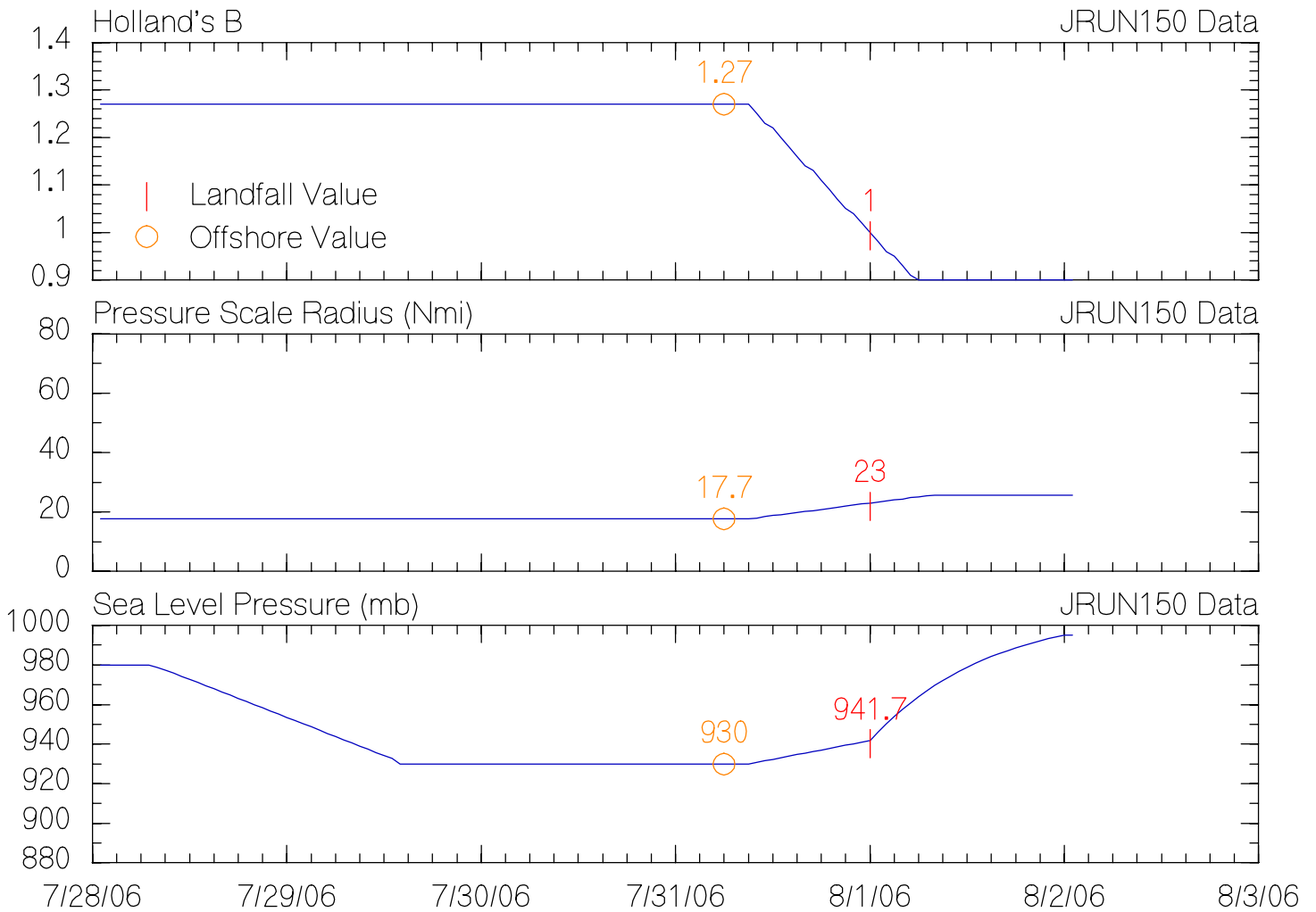
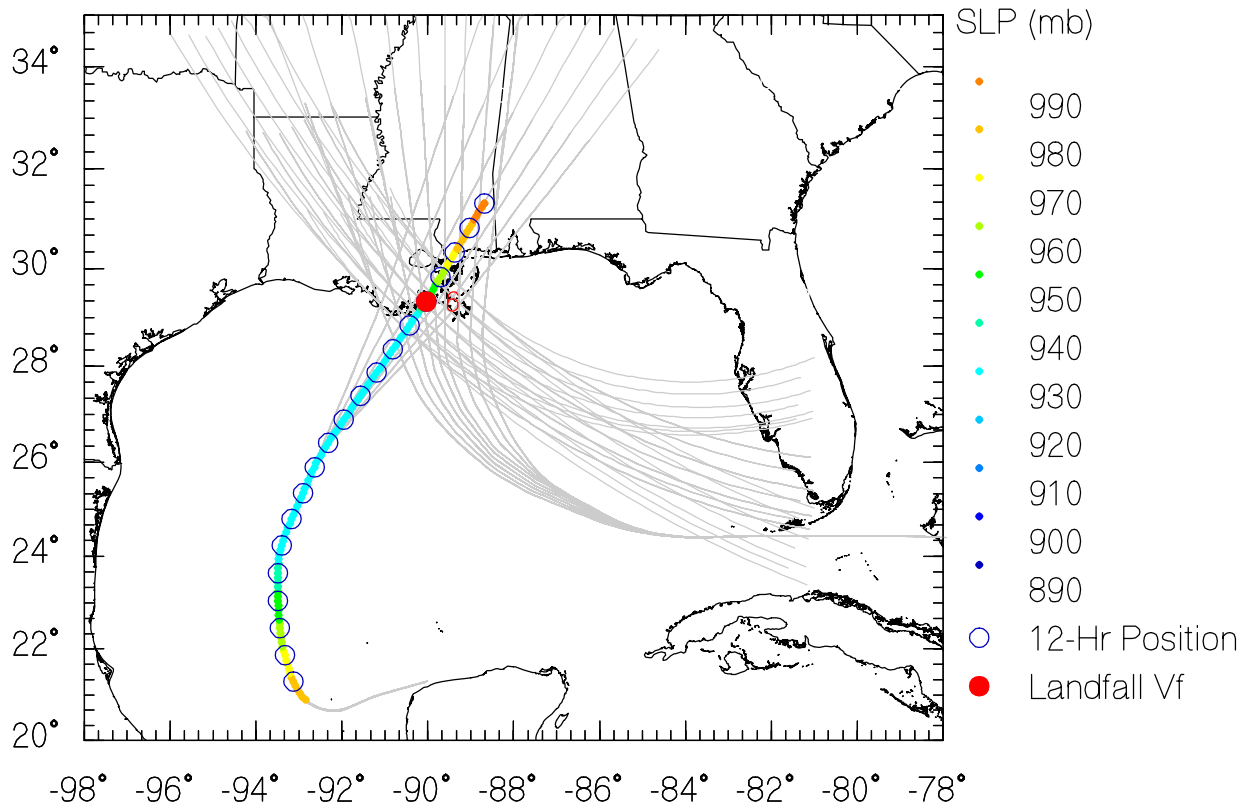

JRUN151 Data

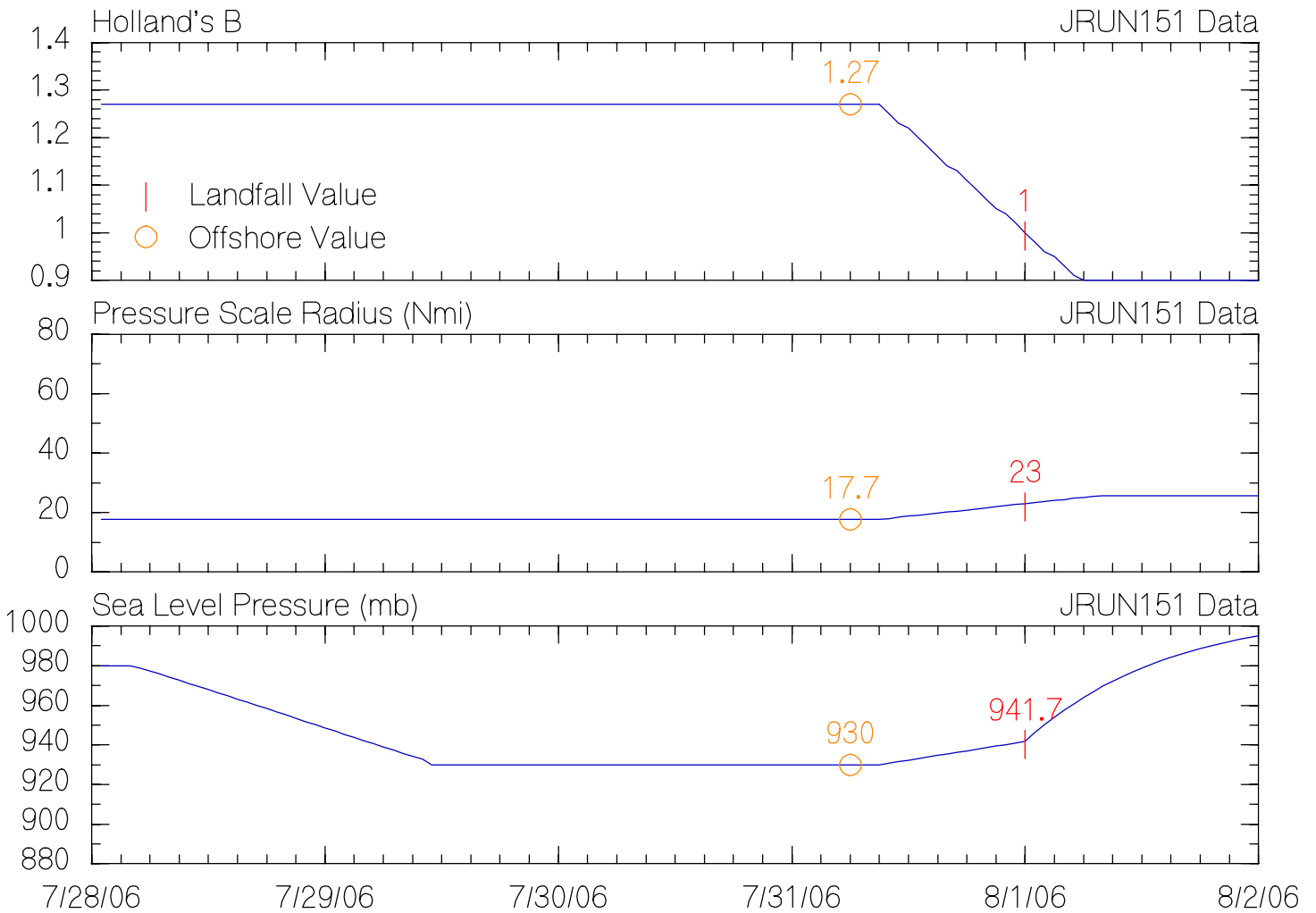
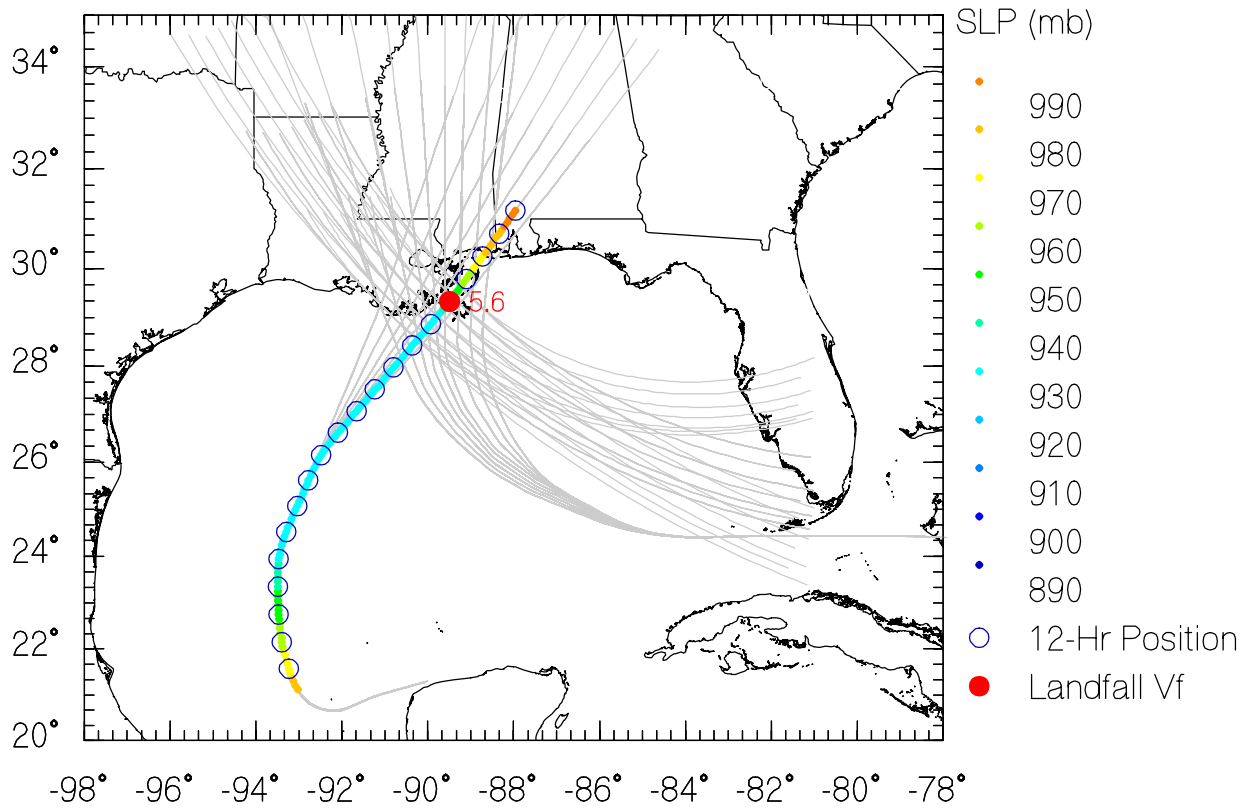

JRUN152 Data

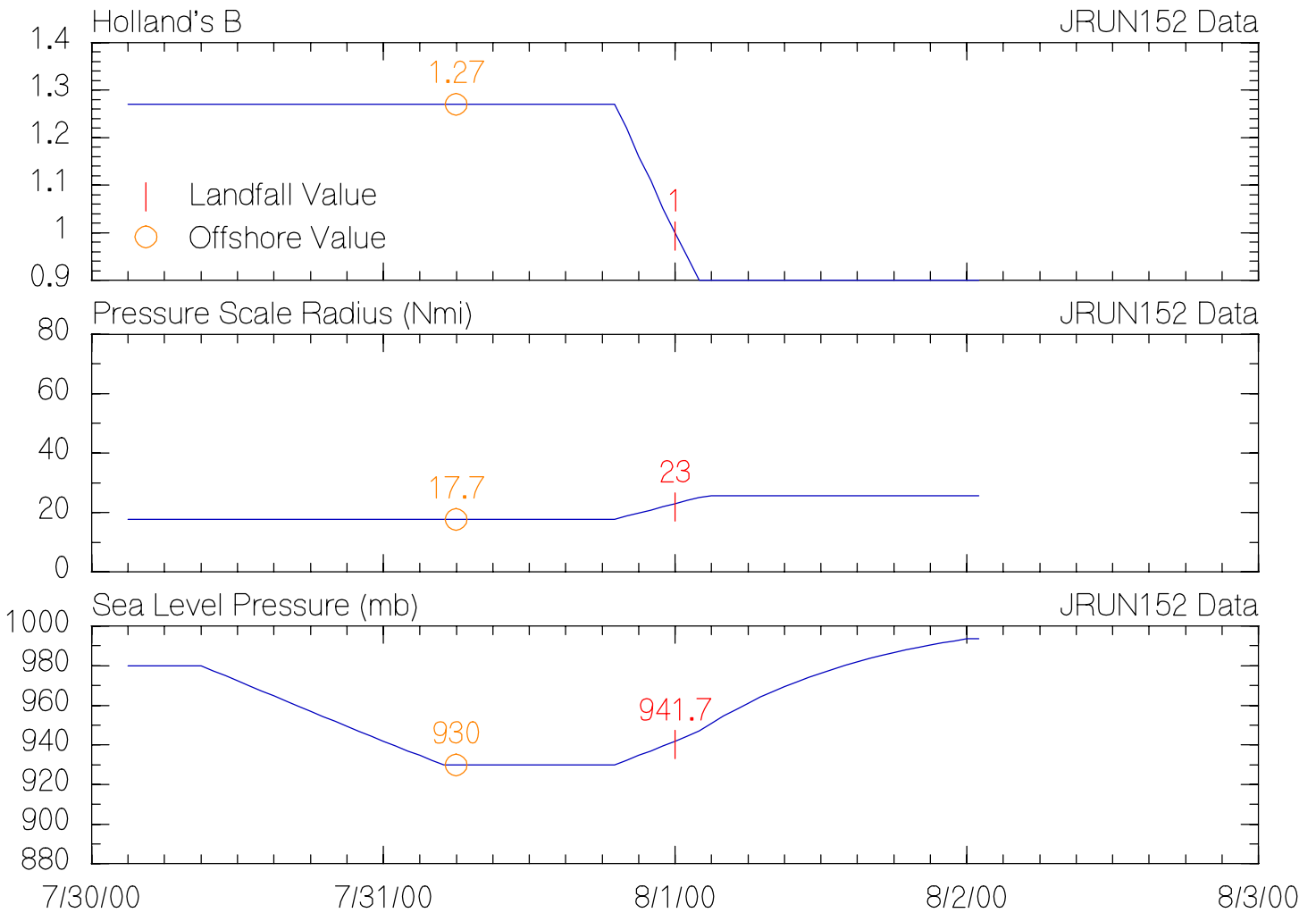
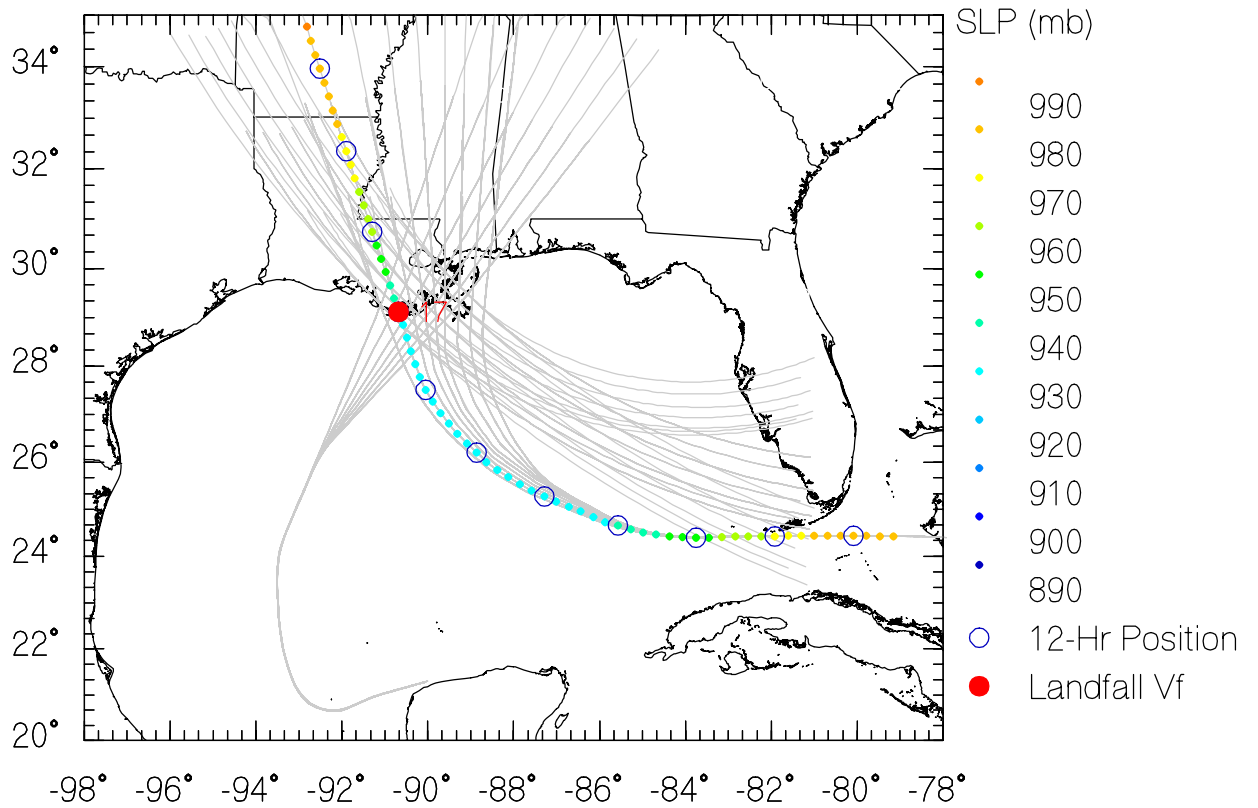

JRUN153 Data

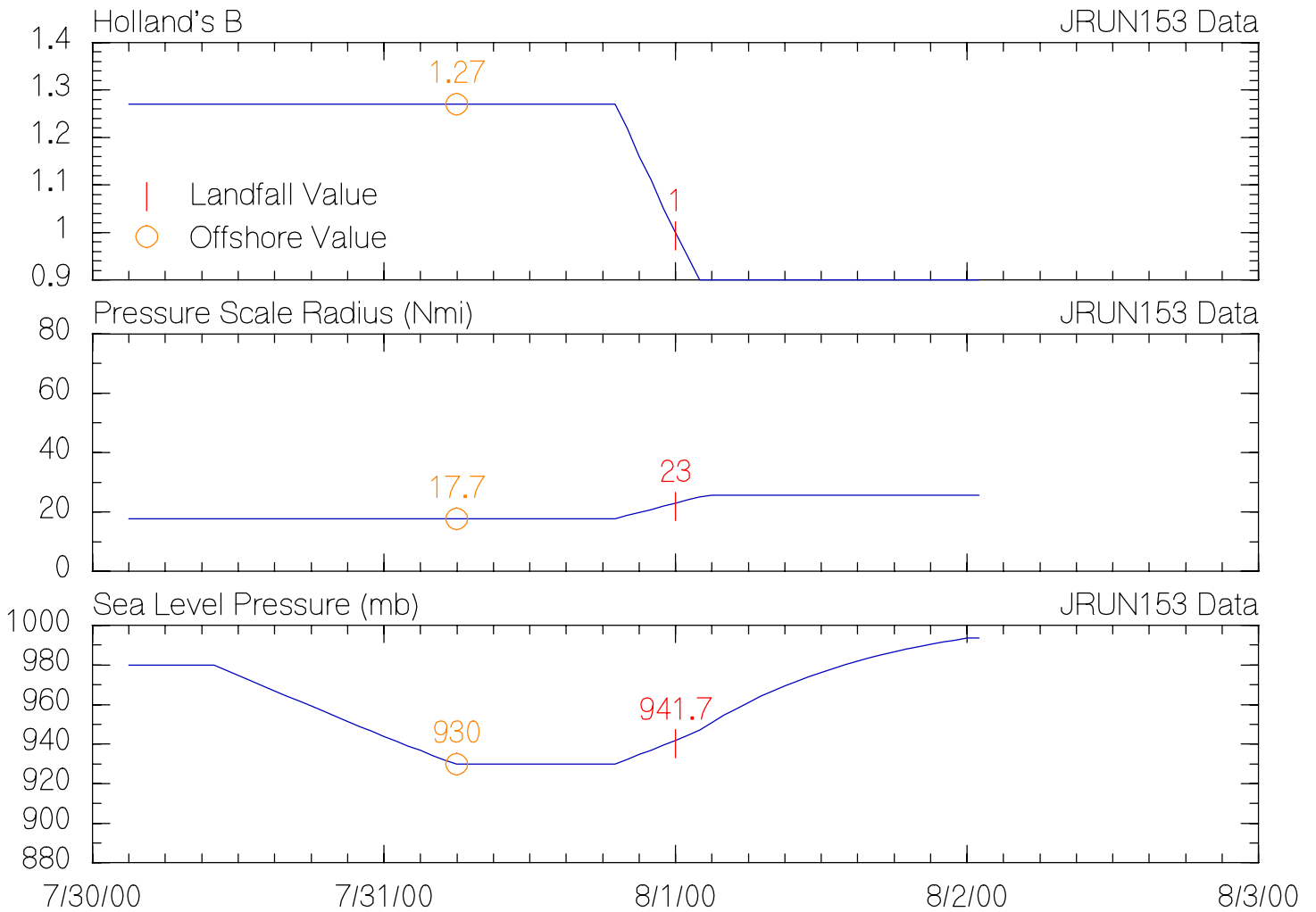
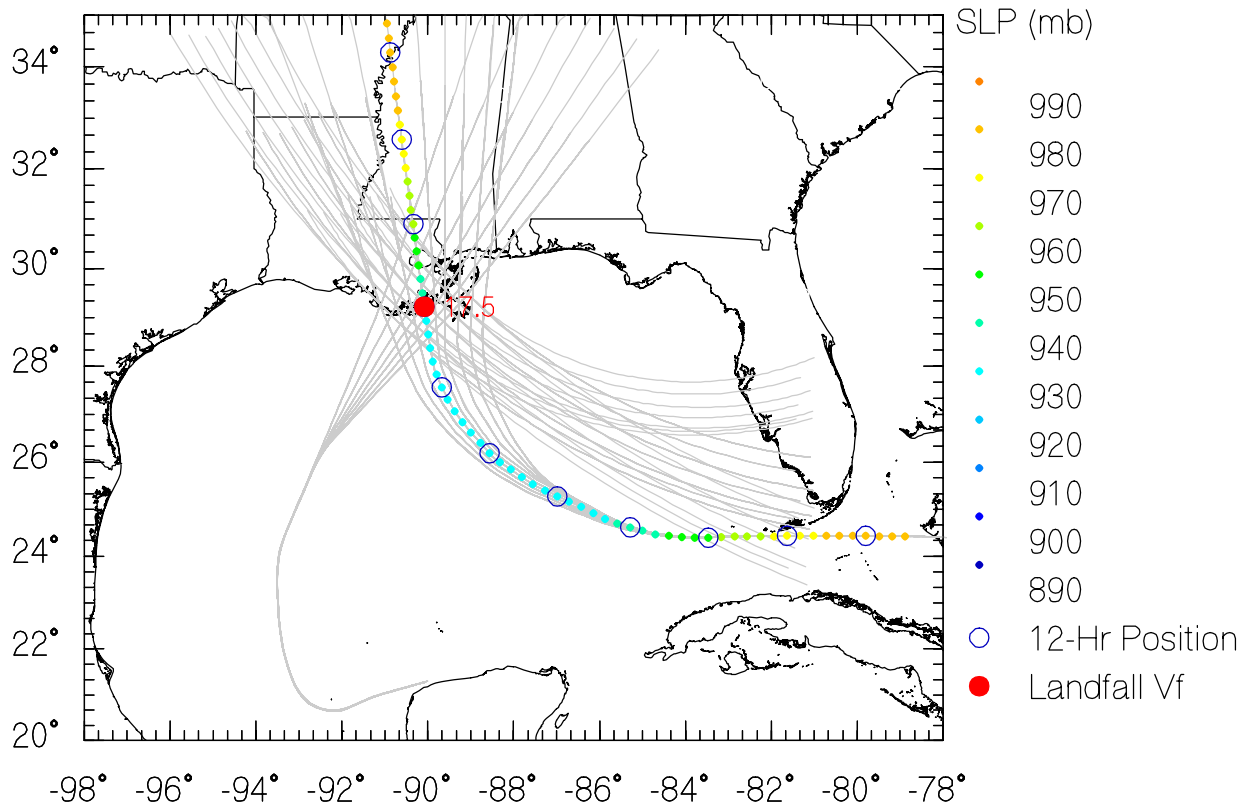

JRUN154 Data

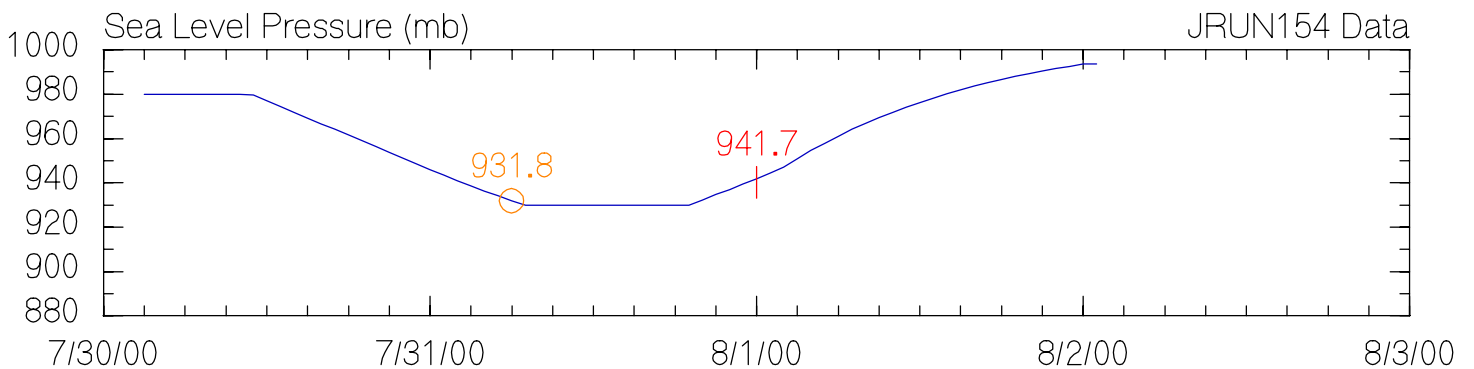
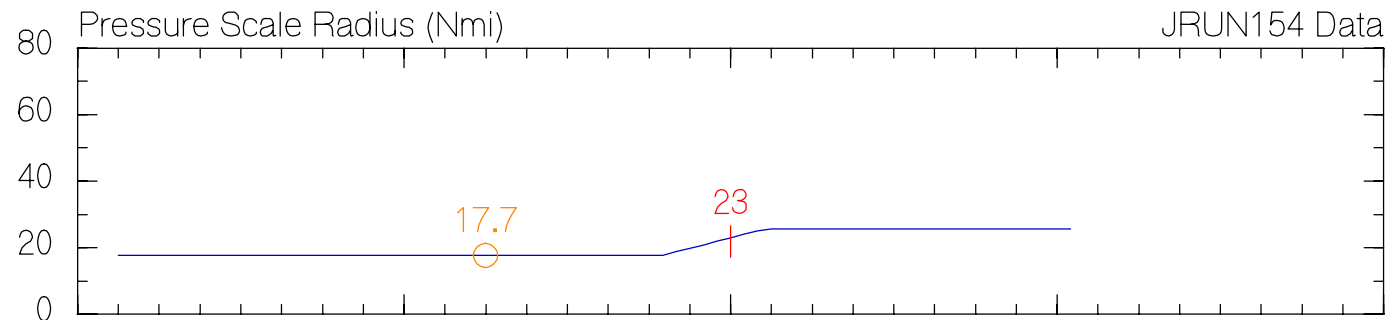
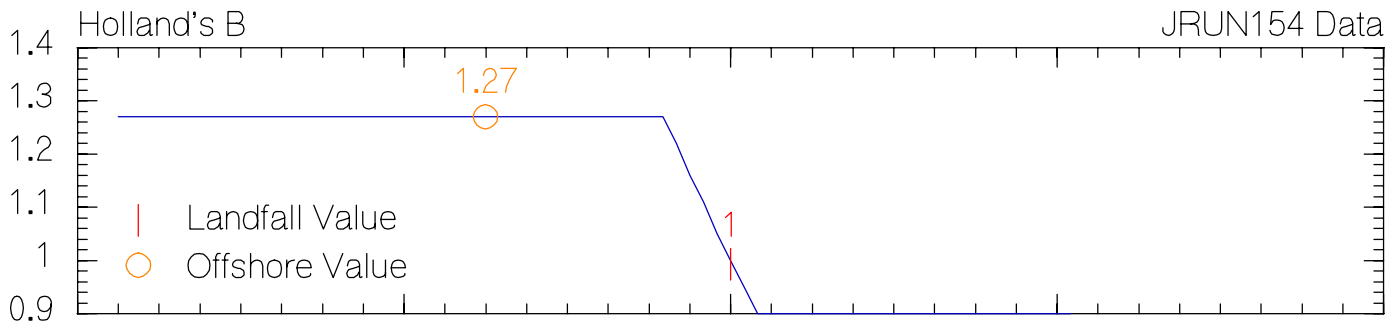
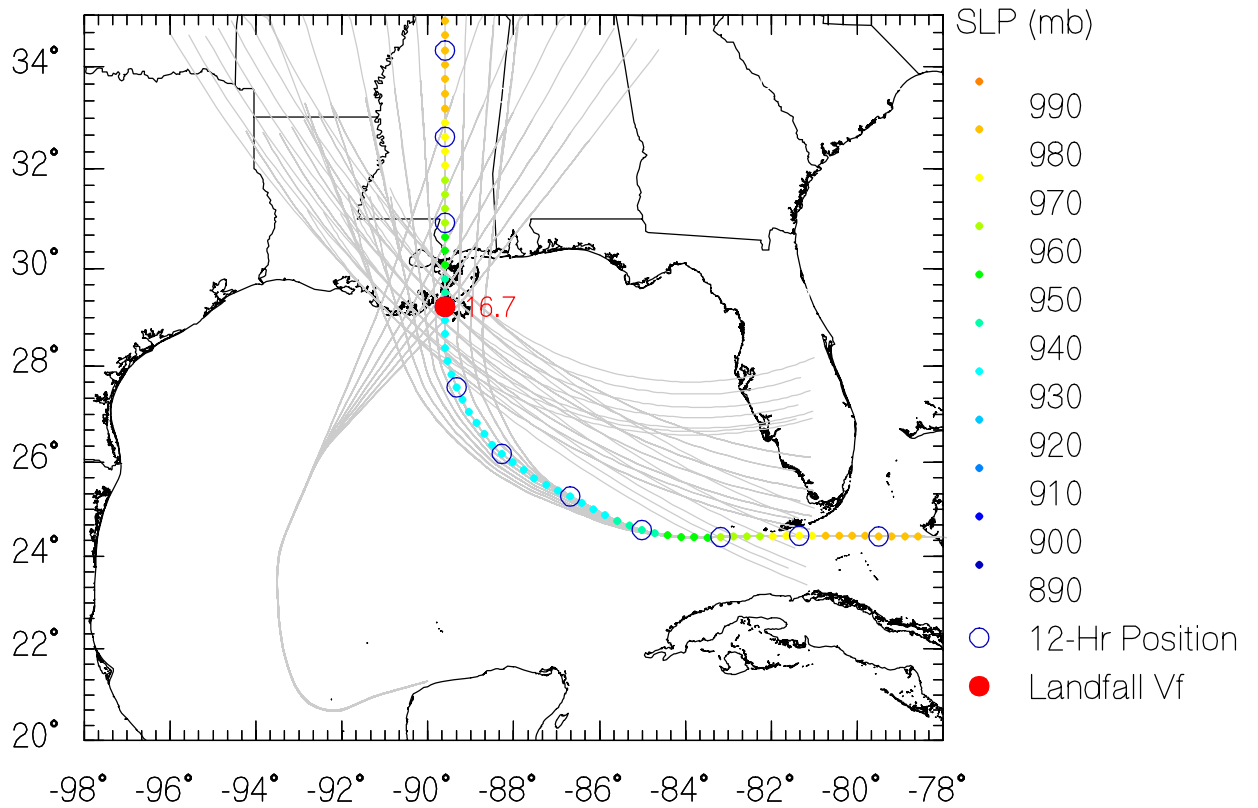

JRUN155 Data

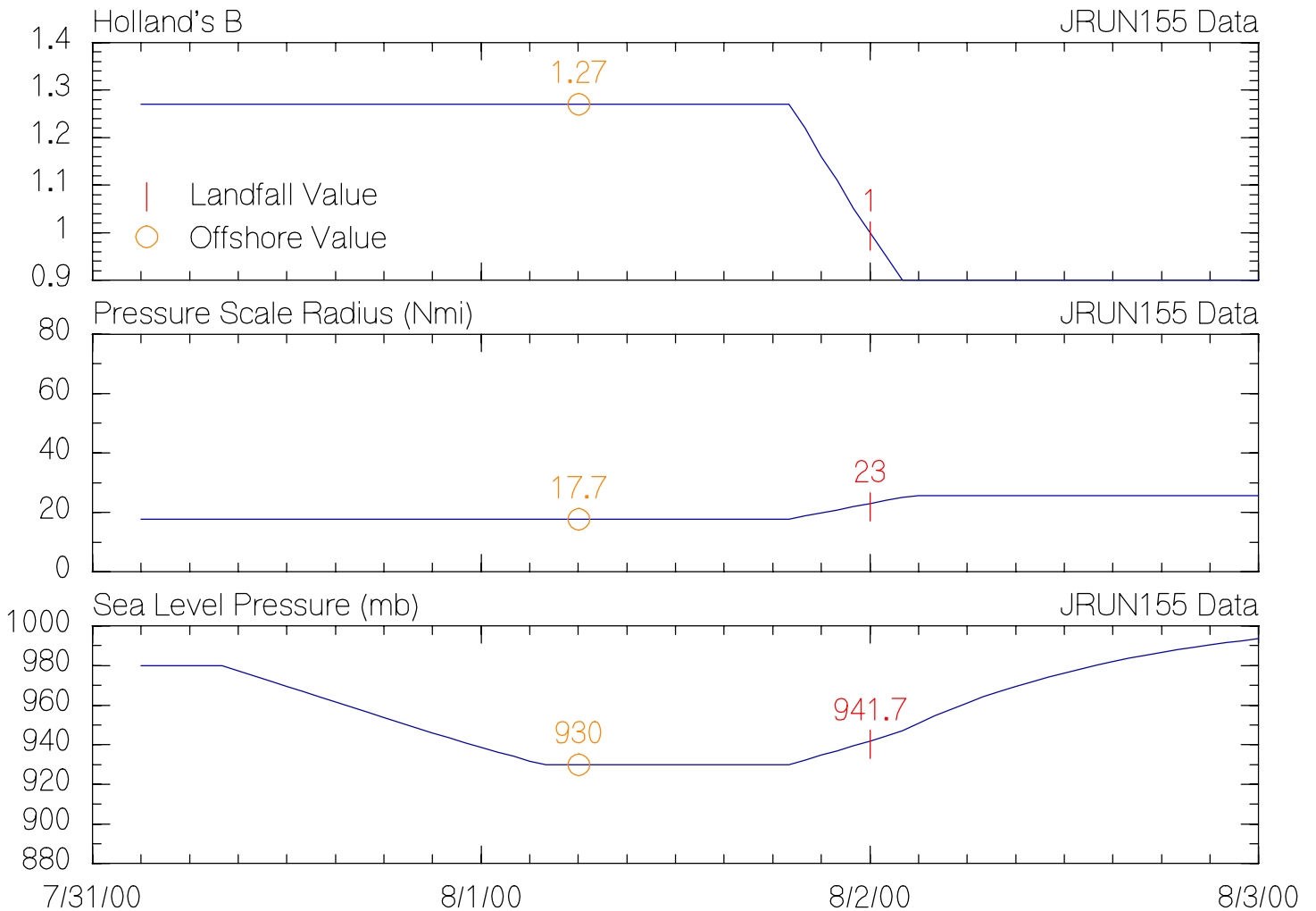
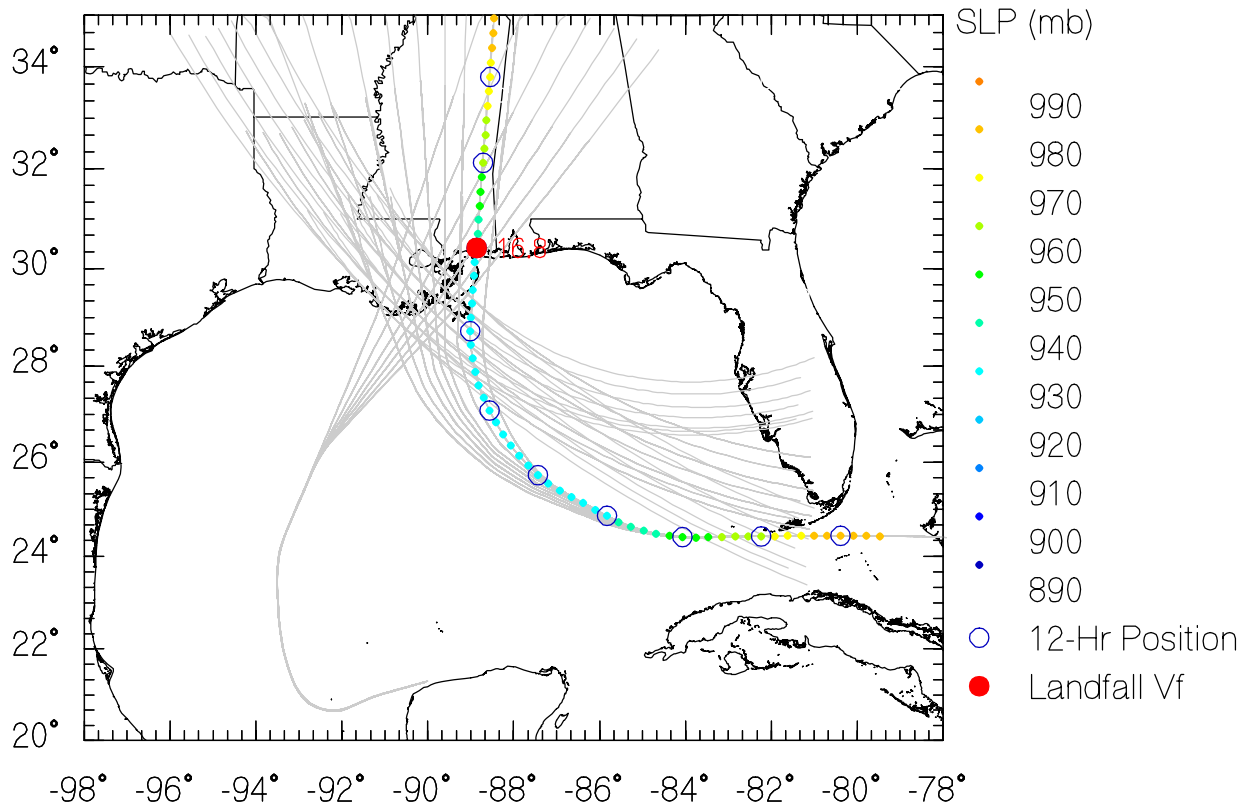

JRUN156 Data

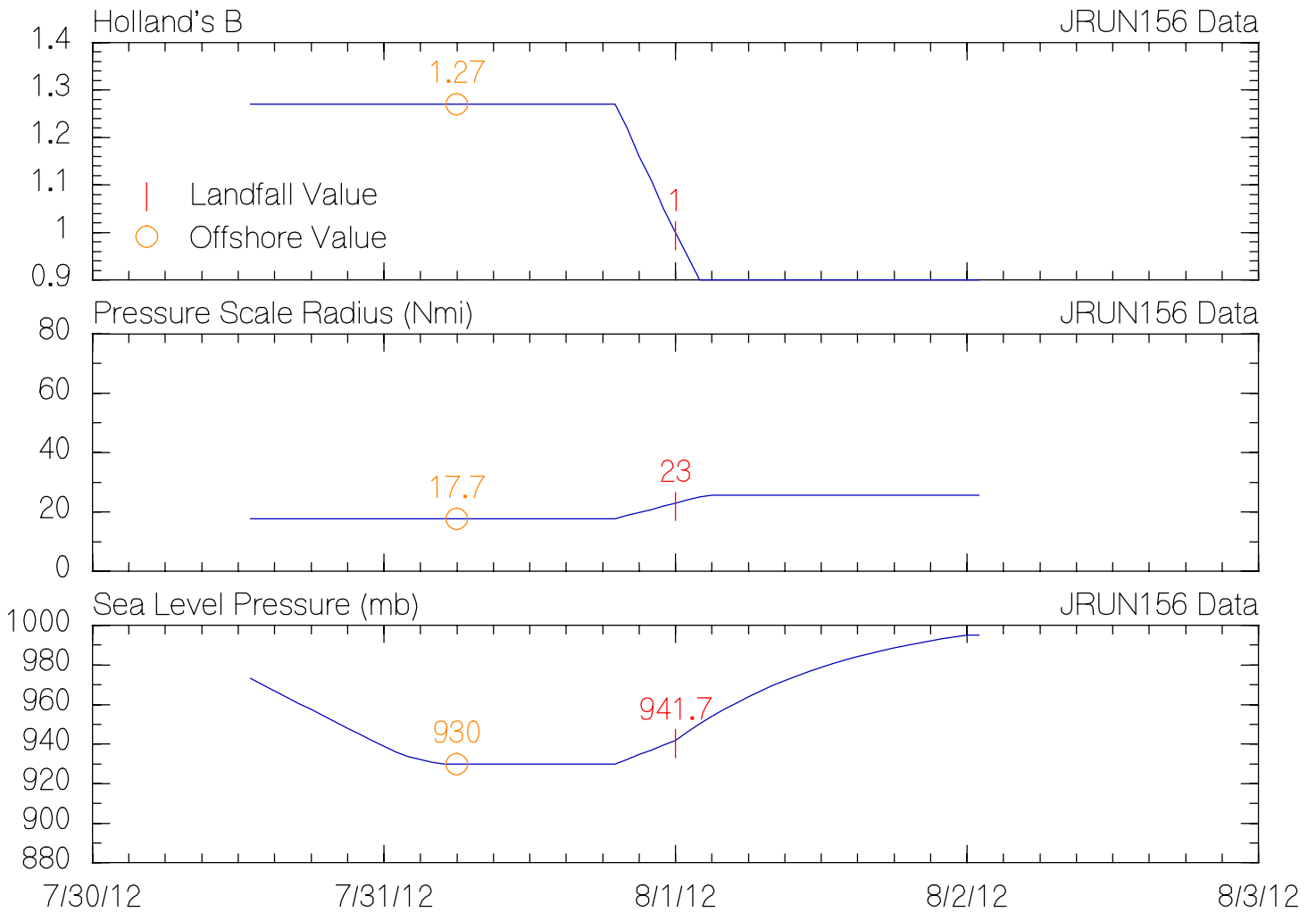
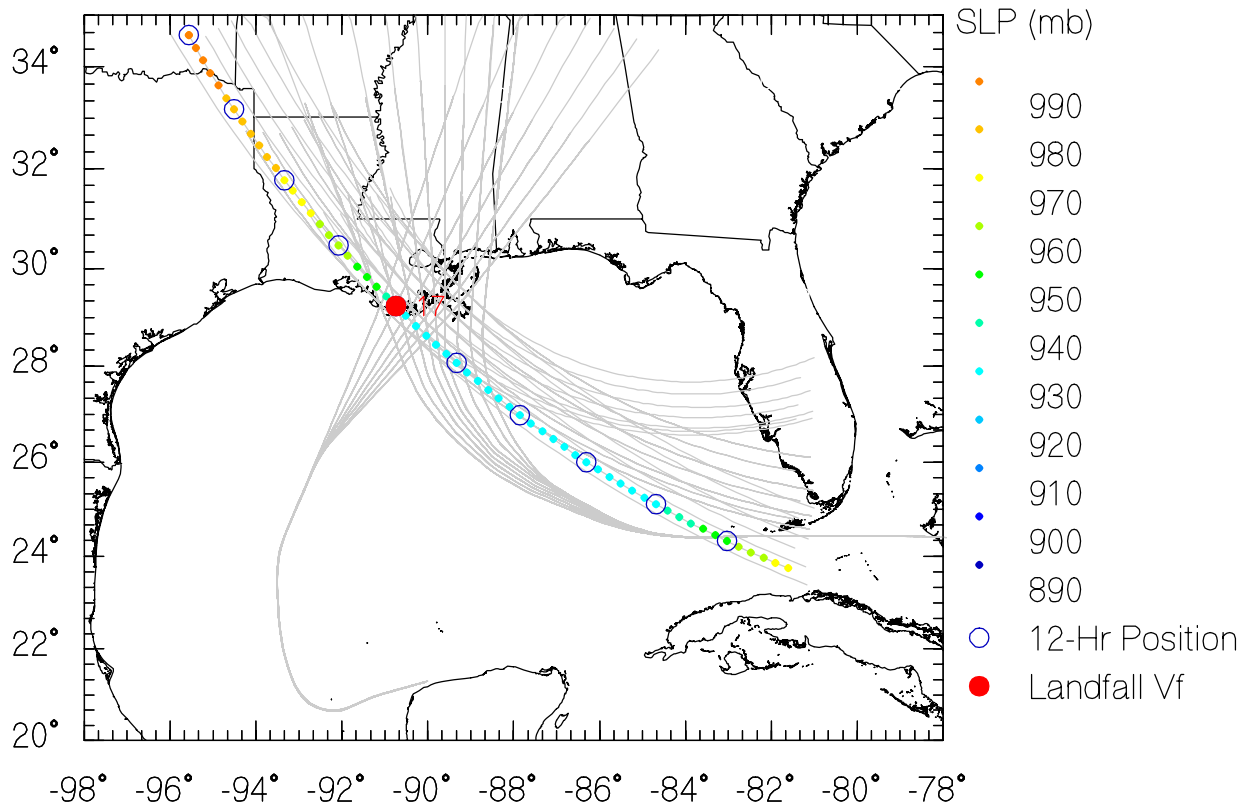

JRUN157 Data

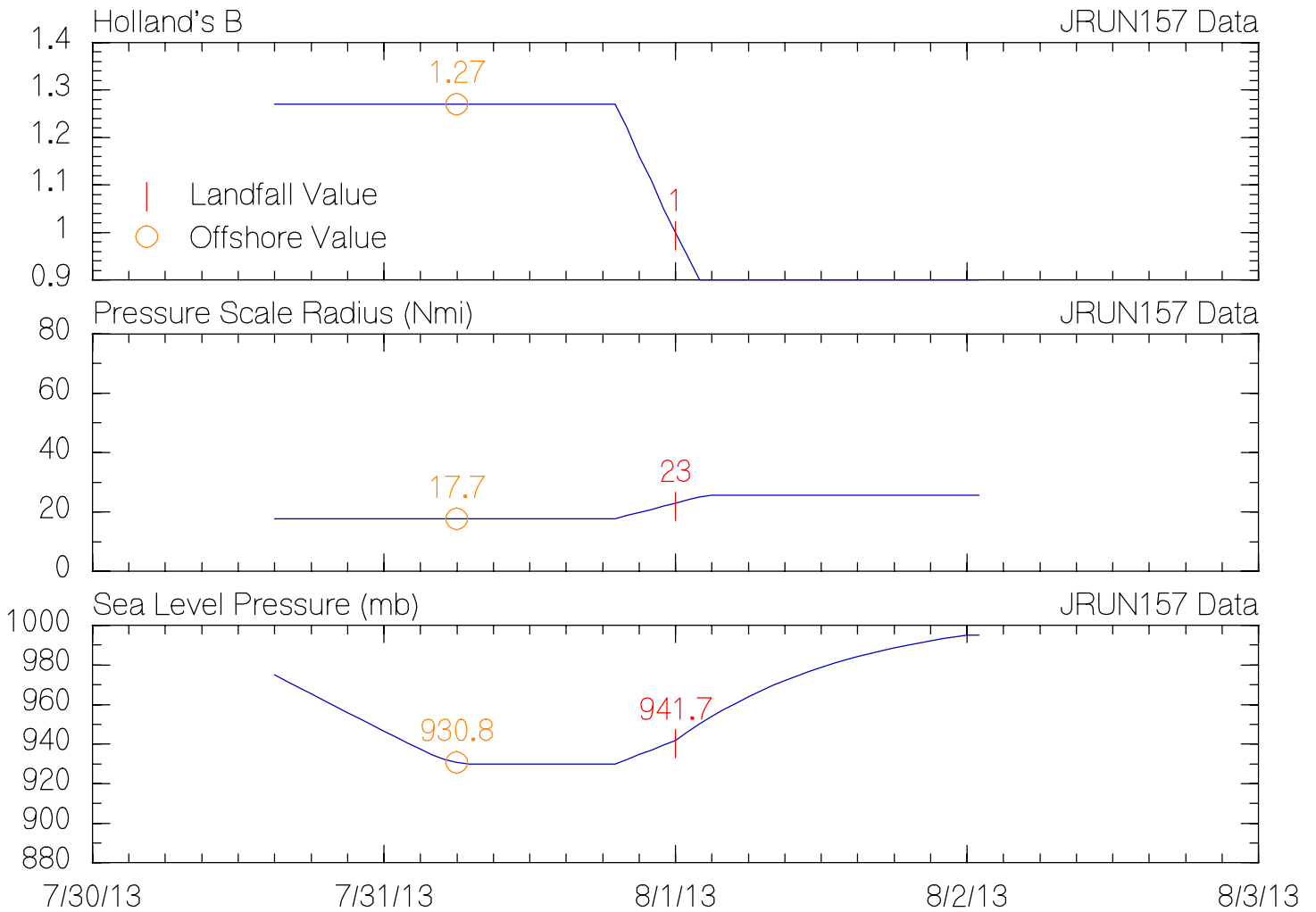
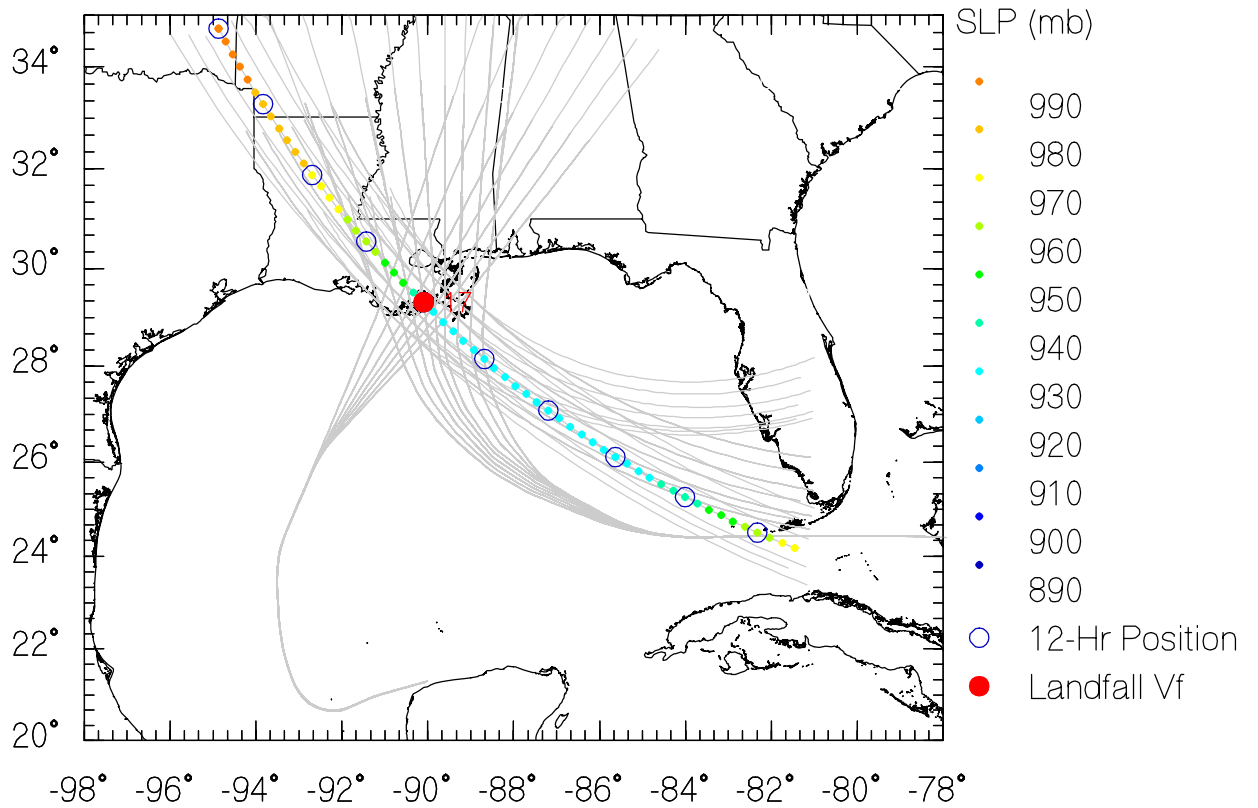

JRUN158 Data

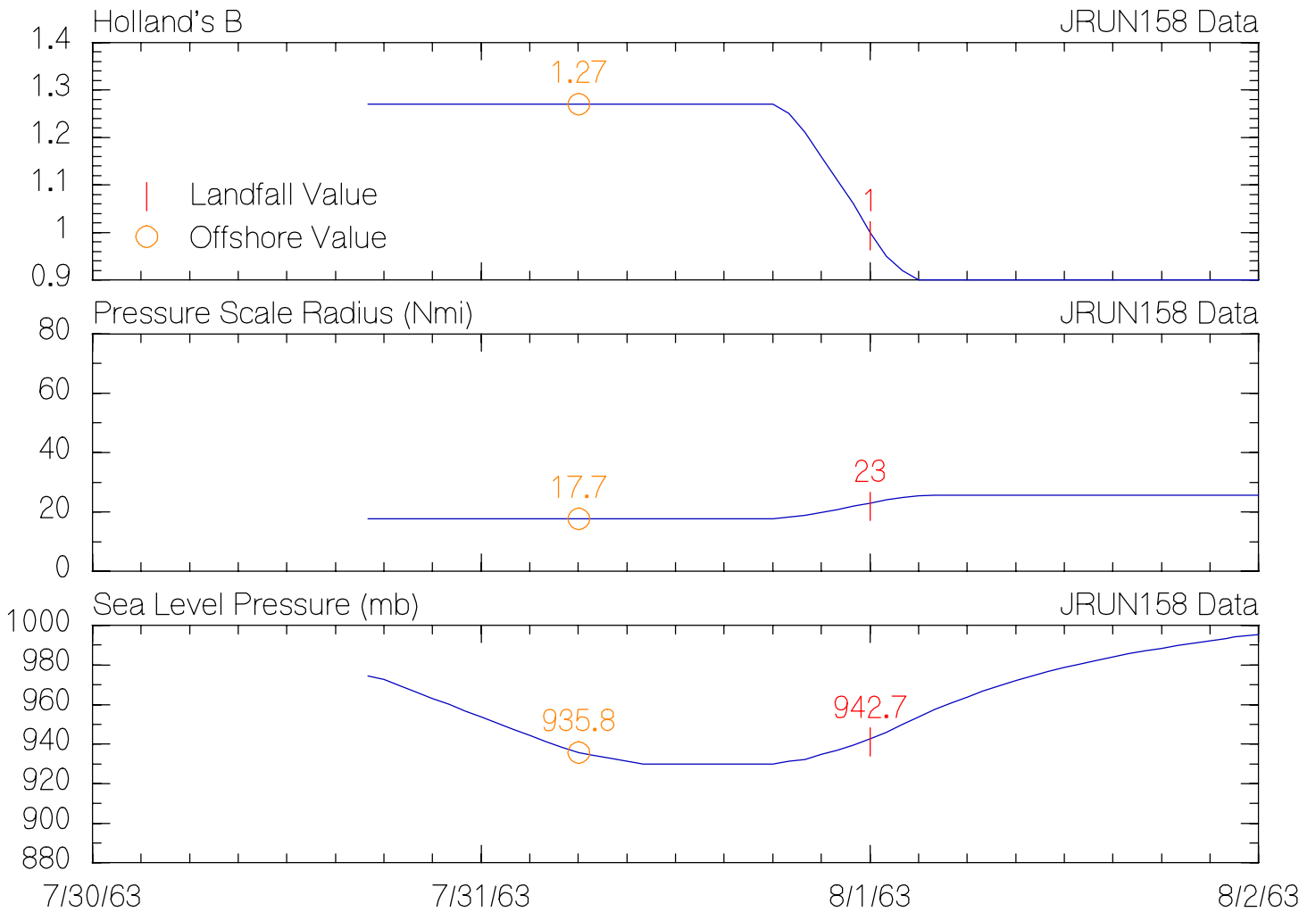
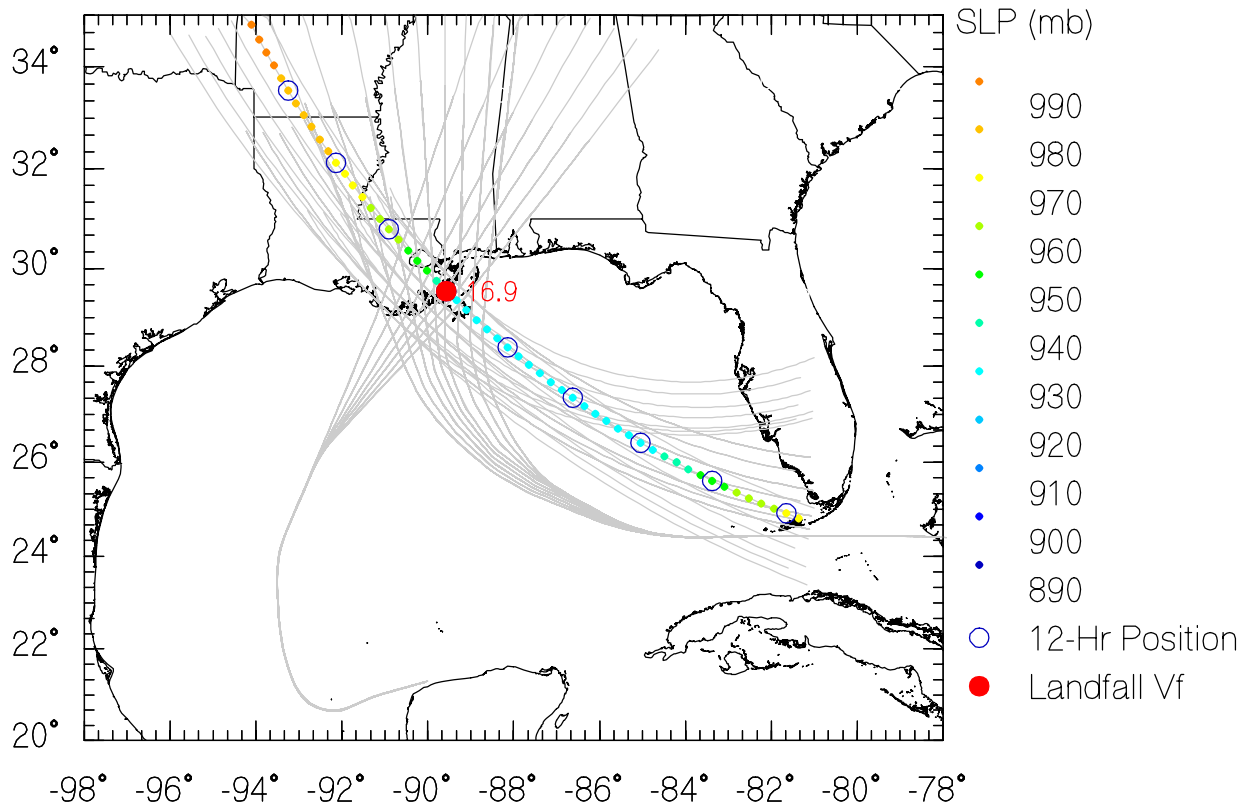

JRUN160 Data

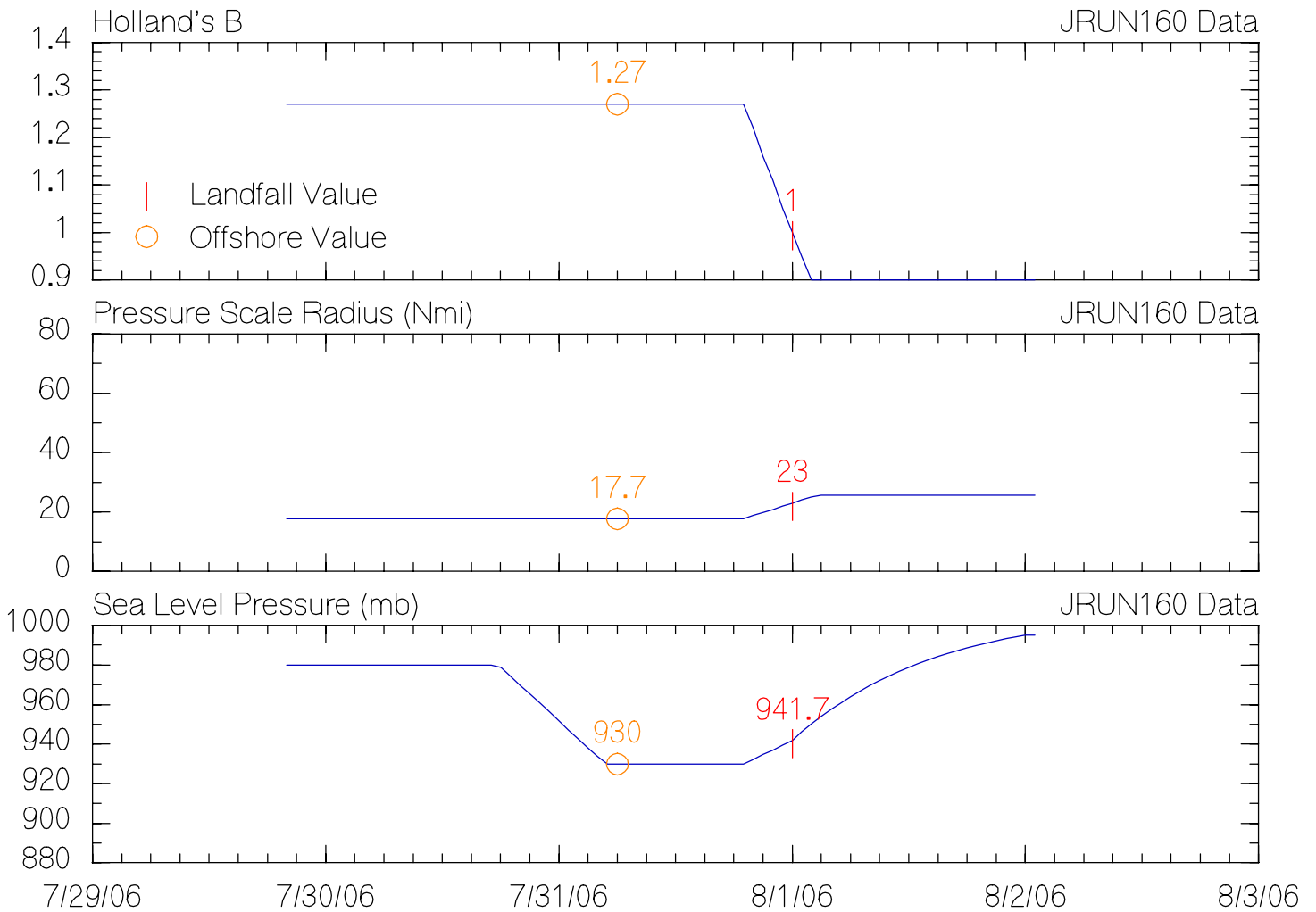
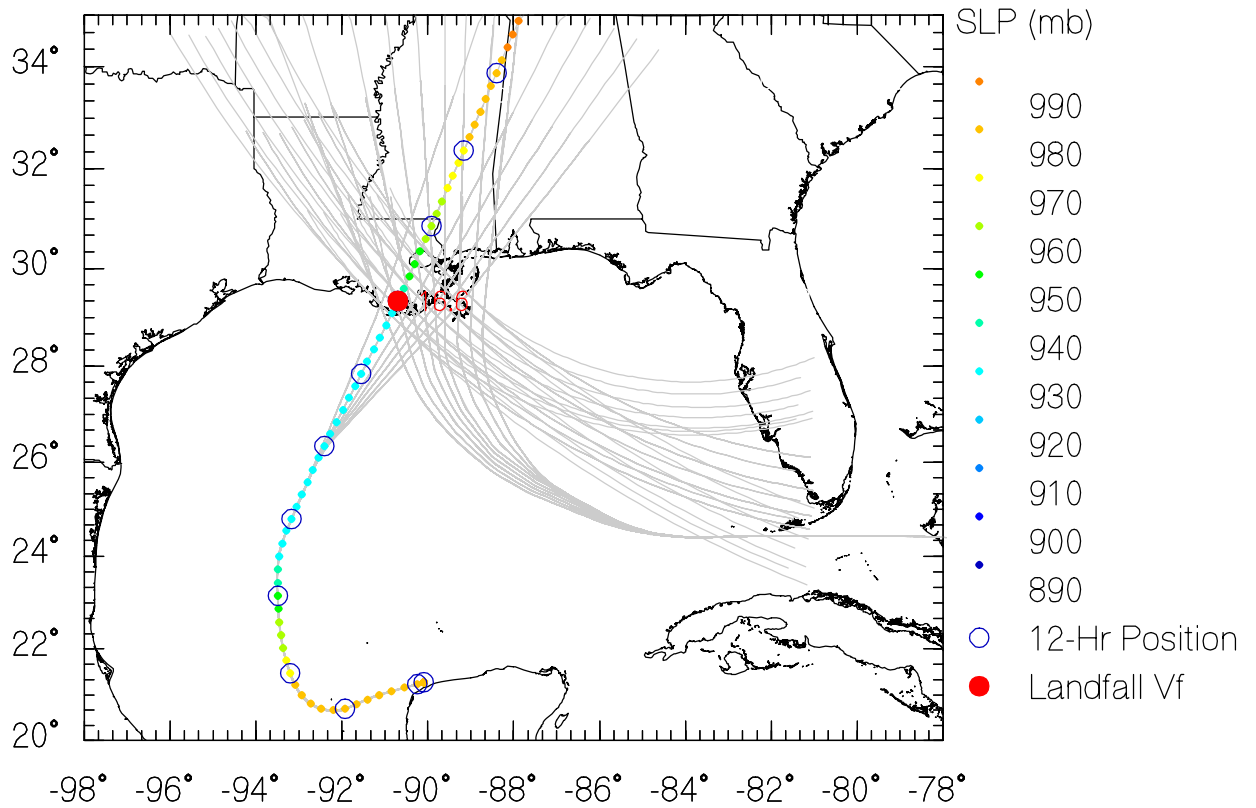

JRUN161 Data

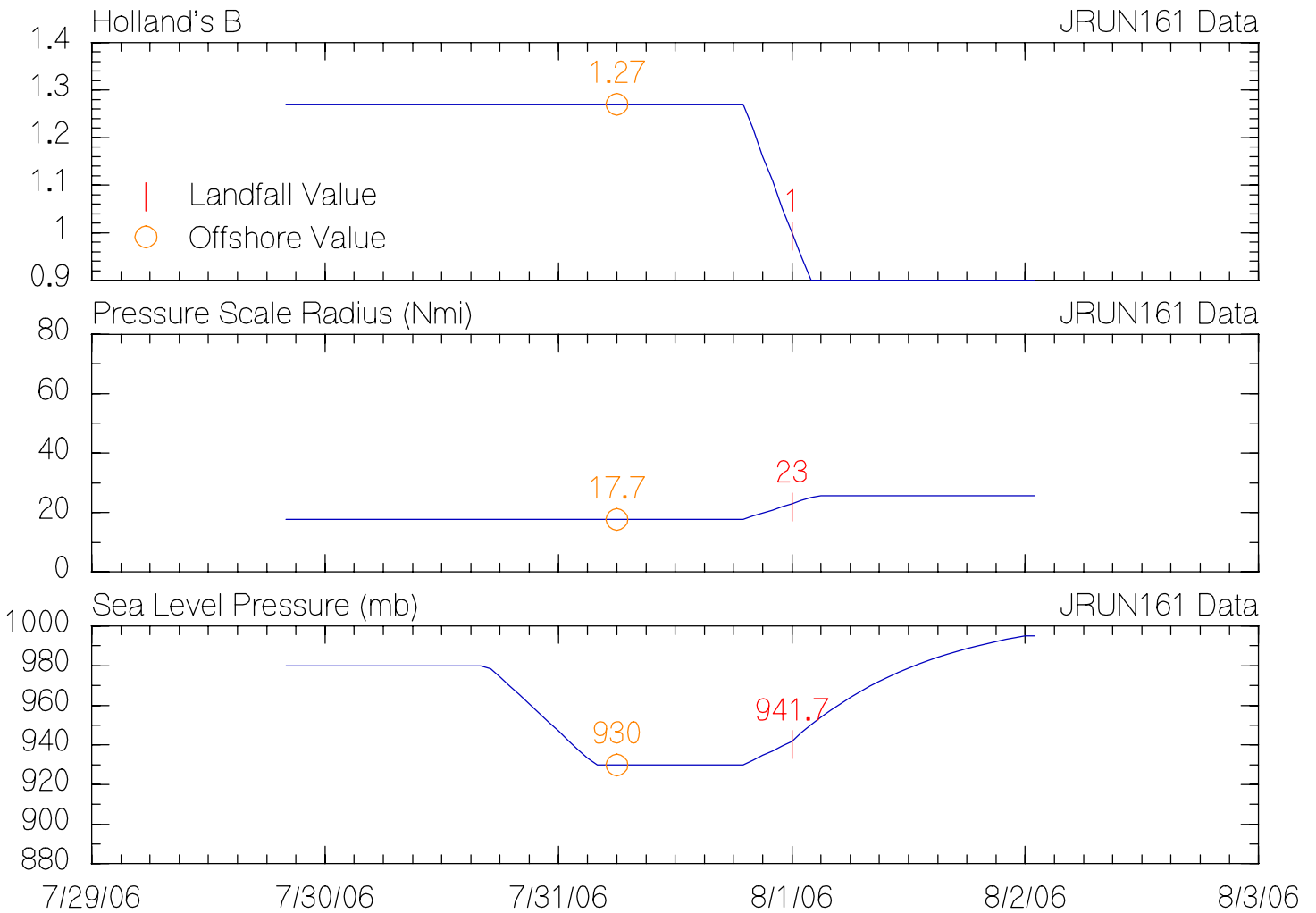
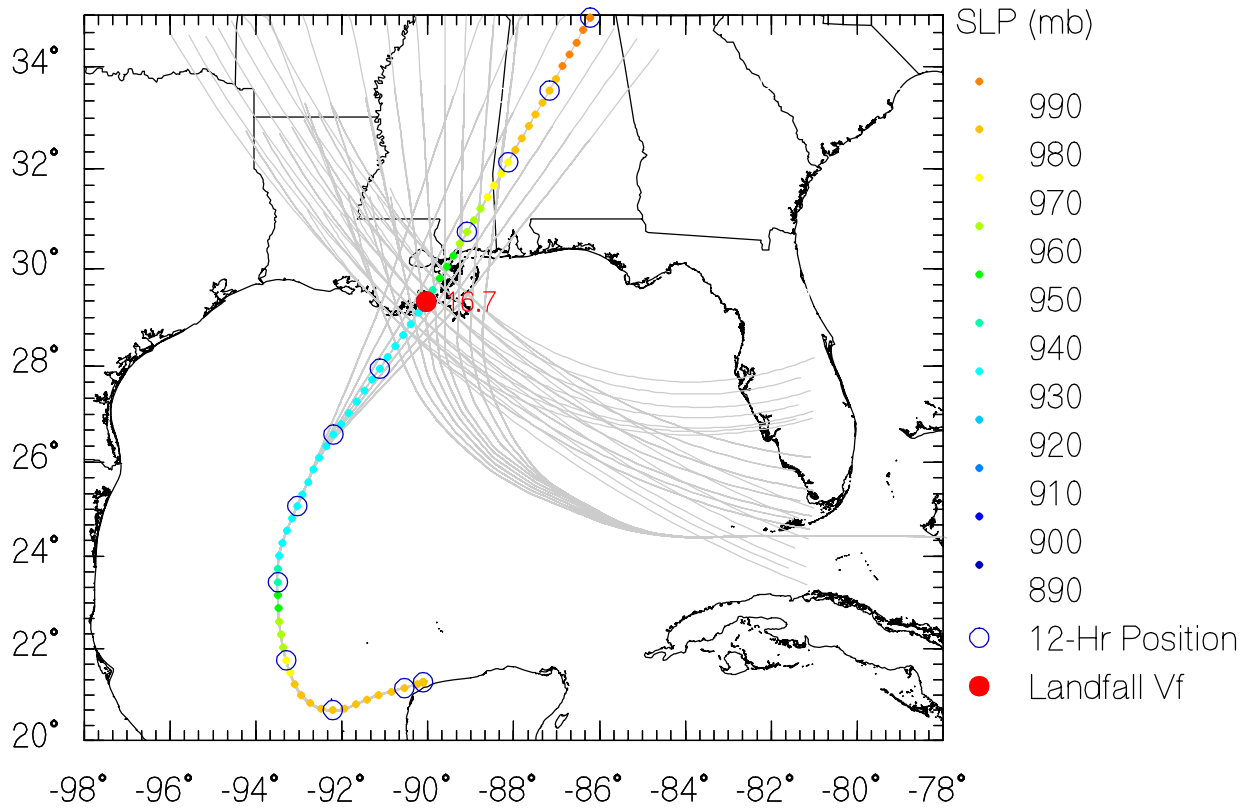

JRUN162 Data

